



 BIONAIRE®

CONSOLE HUMIDIFIER

MODEL W7

Read instructions before operating. Retain for future reference.

Instruction Leaflet

 **INFO-LINE**

If after having read this leaflet, you have any questions
or comments on your humidifier,
call **1-800-788-5350** in North America.

⚠ HUMIDIFIER SAFETY

PLEASE READ AND SAVE THESE IMPORTANT SAFEGUARDS.

IMPORTANT INSTRUCTIONS

When using electrical appliances, basic safety precautions should always be followed to reduce the risk of fire, electric shock, and injury to persons, including the following:

1. Read all instructions before using the appliance.
2. To avoid fire or shock hazard, plug the appliance directly into a 120 Volt AC electrical outlet.
3. Keep the cord out of heavy traffic areas. To avoid fire hazard, NEVER put the cord under rugs, near heat registers, radiator, stoves, or heaters.
4. DO NOT place humidifier near heat sources such as stoves, radiators, and heaters. Do locate your humidifier on an inside wall near an electrical outlet. The humidifier should be at least 4" away from the wall for best results.
5. NEVER place humidifier in an area where it is accessible to children. NEVER use humidifier in a closed room, particularly where a child may be sleeping, resting, or playing (a closed room may result in excessive humidity).
6. WARNING: Do not attempt to refill humidifier without first unplugging the unit from it's electrical outlet. Failure to heed this warning may cause personal injury.
7. NEVER drop or insert any object into any openings.
8. DO NOT operate any appliance with a damaged cord or plug, after the appliance malfunctions, or if it has been dropped or damaged in any manner. Return appliance to manufacturer for examination, electrical or mechanical adjustment, or repair.
9. Use appliance only for intended household use as described in this manual. Any other use not recommended by the manufacturer may cause fire, electric shock, or injury to persons. The use of attachments not recommended or sold by Bionaire may cause hazards.
10. DO NOT use outdoors.
11. Always place humidifier on a firm, flat, level surface. A waterproof mat or pad is recommended for under the humidifier. NEVER place it on a rug or carpet, or on a finished floor that may be damaged by exposure to water or moisture.
12. DO NOT allow the air outlet grill to directly face the wall. Moisture could cause damage, particularly to wallpaper.
13. Humidifier should be unplugged when not in use.
14. NEVER tilt, move, or attempt to empty unit while

it is operating. Shut off and unplug before removing the water reservoir and moving the unit.

15. This humidifier requires daily and weekly maintenance. Refer to daily and weekly cleaning procedures.
16. NEVER use detergents, gasoline, glass cleaner, furniture polish, paint thinner, or other household solvents to clean any part of the humidifier.
17. Excessive humidity in a room can cause water condensation on windows and some furniture. If this happens, turn the humidifier OFF.
18. Do not use humidifier in an area where humidity level is in excess of 50%. Use the hygrometer, such as Bionaire models BT400 or BT254, to measure the humidity.
19. DO NOT attempt to repair or adjust any electrical or mechanical functions on this unit. Doing so will void your warranty. The inside of the unit contains no user serviceable parts. All servicing should be performed by qualified personnel only.
20. Never place housing under water flow or immerse in liquids.
21. Do not fill through air inlet or outlet grill.
22. Do not plug in the cord with wet hands: electric shock could result.
23. Do not block air inlet or outlet grills.
24. Do not place blower housing or cord under water flow, pour water over, or immerse in liquid.

PLEASE READ AND SAVE THESE IMPORTANT SAFETY INSTRUCTIONS.

CONSUMER SAFETY INFORMATION

To avoid an electrical circuit overload, do not operate another high wattage product on the same circuit with the heater.

This appliance is equipped with a grounded type 3-wire cord (3-prong plug). This type of plug will only fit into an electrical outlet made for a 3-prong plug. This is a safety feature intended to help reduce the risk of electrical shock. If the plug should fail to fit, contact a qualified electrician to replace the obsolete outlet.

DO NOT DEFEAT THE SAFETY PURPOSE OF THIS GROUNDED PLUG IN ANY WAY.

The length of the cord used on this product was selected to reduce the hazards of becoming

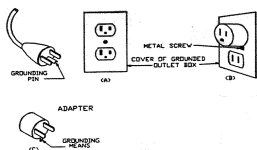

tangled in, or tripping over a longer cord. If a longer cord is necessary an approved extension cord may be used. The electrical rating of the extension cord must be equal to or greater than the rating of the heater. Care must be taken to arrange the extension cord where it cannot be pulled on by children or accidentally tripped over.

HOW YOUR BIONAIRE® HUMIDIFIER WORKS

Your BIONAIRE®

Console Humidifier draws dry, dust-laden air through the rear mounted air filter with its twin turbo fan. This cleansed air is then passed through two moisture-laden wick cartridges and the resulting moist air is directed back into the room from the air outlet grill. In addition, the W7 incorporates a multi-stage electret/carbon filter cartridge to remove airborne particulate pollutants.

- A. Filter Door Access
 - Dual Filter Cartridge
 - Washable Air Filter
- B. Control Panel
- C. Air Outlet Grill
- D. Removable Water Reservoir
- E. Carry Handle
- F. Air Filter
- G. Condition Monitor
- H. Blower Housing

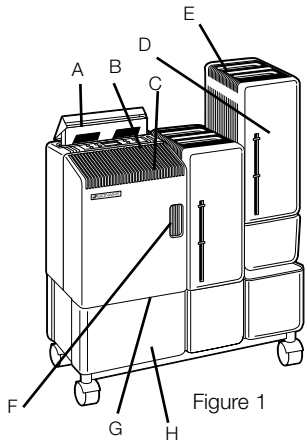

Figure 1

OPERATING INSTRUCTIONS

1. Remove the reservoirs and blower housing and lay base on its side. Insert the four casters in the openings in the base (see figure 2). Turn upright. Place your BIONAIRE® humidifier in the desired location. A level surface is recommended for proper operation.

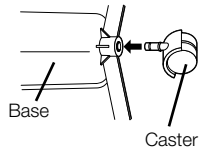

Figure 2

2. Verify that the float is properly installed (see figure 6). It is essential that the float be properly positioned for the refill light to illuminate when the water level is low. Replace the blower housing. Fill the reservoirs with water as directed under the heading "Filling the Water Reservoirs." Place the water reservoirs back in the unit and allow up to 30 minutes for the water tray to fill and the evaporative wicks to become saturated.

3. Plug the power supply cord (the end which does not have prongs extending from it) into rear of the unit and into the most convenient 120V AC grounded wall receptacle. The power light will illuminate when the power button is pushed.
4. To set the digital humidistat, see the section title "Setting the Digital Humidistat Control." To operate without the digital humidistat simply press the mode button until the desired speed is displayed on the left side of the control panel.

NOTE: If AUTO appears at the bottom left of the control panel then the humidistat is in AUTO mode, press the mode button until the AUTO disappears. The unit will now be in manual mode at HIGH speed. Continue pressing the mode button to choose MED, or LOW manual settings.

5. When all the water in the reservoirs has been used, the refill light will illuminate. The fan will operate on low speed and circulate filtered air in the room; however, no moist air will be produced until the water reservoirs are refilled. Follow instructions under "Filling the Water Reservoir."

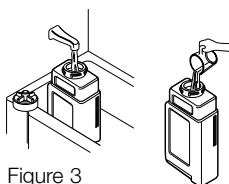

Figure 3

FILLING THE WATER RESERVOIR

1. Be sure the unit is off and disconnected from the electrical outlet.
2. The water reservoirs can be filled by removing the reservoir cap. To remove the reservoir cap, twist it counter-clockwise approximately 1/4 turn. Hold the reservoir upside down under the faucet to fill. A deep sink or bathtub is required. After filling the water reservoir, replace the reservoir cap. Make sure the large O-ring is in its correct position, then align the arrows on the cap and reservoir and turn clockwise 1/4 turn.
3. Replace each full reservoir on to your humidifier. Turn the humidifier back on and set at the desired level. After a few minutes, the water tray will fill and the refill light will turn off.

SETTING THE DIGITAL HUMIDISTAT CONTROL

The programmable digital humidistat is designed to operate between 30% and 65% relative humidity range. The recommended setting is between 40% and 45%.

1. To program a preset humidity level, press the mode button until AUTO appears at the bottom left of the control panel. The AUTO setting will begin with HIGH. Continue pressing the mode button to choose AUTO MED, or AUTO LOW.
2. Once you have chosen your AUTO speed press the + or - buttons to choose your humidity setting. The humidity

settings can be set in multiples of 5, beginning with lowest setting 30% and ending with the highest setting 65%. Choose the desired setting and your programmable humidistat is now set.

NOTE: When the humidity level in the room is less than

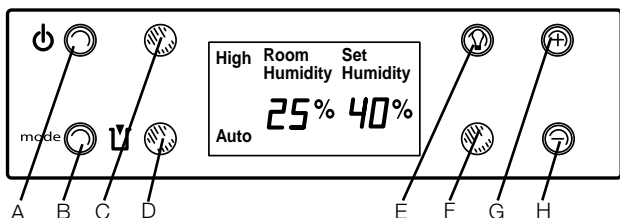

- | | |
|----------------------|----------------------------|
| A. Power Button | F. Nightlight Sensor |
| B. Mode Button | G. Set Humidifier (Higher) |
| C. Power Light | H. Set Humidifier (Lower) |
| D. Refill Light | |
| E. Nightlight Button | |

Figure 4

the humidity level you have programmed the humidifier will continue to produce moisture. Once the pre-set humidity level is met, the humidifier will stop producing moisture. As the room humidity approaches the humidity the units speed will decrease if it has been set at Auto High or Auto Low.

REPLACING THE AIR FILTER CARTRIDGE

To keep your unit operating at peak efficiency, the dual filter cartridge should be replaced when indicated by the filter monitor, located on the front of your unit.

1. Push the power button so the power light is off and disconnect the unit from the electrical outlet.
2. Open the filter access door and remove the used filter.
3. Remove the replacement cartridge from the printed box.

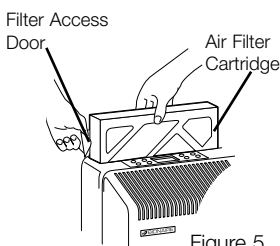

Figure 5

- Discard any protective plastic wrapping. Install the cartridge by sliding it completely into the unit, as shown in Figure 5, with the electret side of the filter cartridge (white side) facing towards the rear of the unit. Do not remove the filters from the cardboard frame, this will destroy the cartridge.
4. Close the filter access door.
5. Plug the unit back into the electrical outlet and push the Power button to turn it on.

REPLACING THE EVAPORATIVE WICK FILTER

To ensure peak efficiency of your humidifier, it is recommended to replace the wicks a minimum of every season or more often as needed. The wick cartridges should be replaced once they become saturated with mineral deposits, which is indicated by a brown filter. The frequency of replacement depends on the hardness of the water being used and the amount of use.

1. Push the power button so the green power light is off.
2. Disconnect the power cord from the wall outlet and the unit.
3. Remove the blower housing by carefully lifting it off the humidifier base. Do not plug unit in when the blower housing is removed from the base.

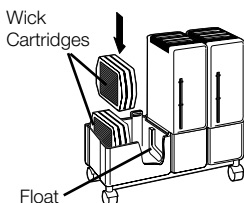

Figure 6

4. Lift the used wick filter cartridges out of the base and discard (Figure 6).
5. Remove the replacement wick filter cartridges from the printed box. Discard any protective plastic wrapping and install them back into the base.

Do not remove the wicks from the frame; this may damage the filter.

NOTE: It is recommended to clean the base when replacing the wick filter cartridges. Refer to the "Cleaning and Maintenance" for further details.

6. Place the blower housing back on the humidifier base.
7. Follow "Operating Instructions."



NIGHTLIGHT INSTRUCTIONS

This Bonaire humidifier is equipped with a nightlight which illuminates the control panel screen in a dark room setting. This nightlight operates on a sensor, and will illuminate when the room becomes dark. When the room becomes light, the nightlight feature will automatically turn off. To inactivate the nightlight, simply press the nightlight button on the control panel. To re-activate the nightlight feature, simply press the light button again (to see if light is on, place finger over sensor).

CLEANING AND MAINTENANCE

Regular cleaning of your humidifier is important in order to maintain efficient, healthy, odor-free operation. Water quality varies widely depending on locality and, combined with a build-up of mineral scale in your humidifier, may under certain conditions promote the growth of micro-organisms in the water reservoirs. Cleaning every week, depending on your water conditions, is essential to avoid any bacteria build-up.

Before cleaning, please note the following:

DO NOT use soap, detergents, abrasive, gasoline, glass or furniture polish, or boiling water to clean any part of your BIONAIRE humidifier. These will interfere with the proper operation of your unit. DO NOT use sharp or metal objects to clean mineral deposits in the base. Contact with sharp objects can result in damage to the plastic.

Mineral deposits should be soaked for up to 30 minutes in BIONAIRE's Clean-Away solution or in plain vinegar and water to help with their removal.

CLEANING INSTRUCTIONS:

1. Push the power button so the power light is off and disconnect the unit from the electrical outlet.
2. We recommend that you move your humidifier to a kitchen or bathroom, with water-resistant floor surfaces, before you proceed further with cleaning.
3. Remove the power cord from the unit.
4. Remove the water reservoirs and the blower housing from the humidifier's base and the reservoir caps from the reservoirs.
5. Remove the wick filter cartridges and place in sink or tub as they will leak water when removed from the unit.
6. DO NOT ALLOW WATER TO ENTER THE FLOAT SWITCH OPENING (Figure 6) OR ANY OTHER INLET TO THE BLOWER HOUSING. DO NOT PLACE BLOWER HOUSING OR CORD UNDER WATER FLOW, POUR WATER ON TO IT, OR IMMERSE IN LIQUID.
7. Remove the float from the base and remove any scale using Clean-Away. Fill the base using some Clean-Away solution. Let solution soak for 20 minutes. Rinse thoroughly with warm water to remove scale and all traces of Clean-Away solution before disinfecting.
8. Disinfect the water reservoirs and the base using a solution of one teaspoon of chlorine bleach in one gallon of water. Let solution soak for 20 minutes, swishing every few minutes to wet all surfaces. Empty the reservoirs and the base; rinse thoroughly until bleach smell is gone. Install the wick cartridges, float and blower housing in the base. Ensure that the float is able to move freely in the base with no binding. Fill the reservoirs with fresh water and replace them into the unit.

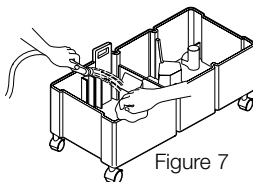

Figure 7

9. Your BIONAIRE® Console Humidifier is now ready for use again. NOTE: The float must be properly installed in the base for the refill light to illuminate when water level is low.

STORAGE TIPS

If you do not plan to use your unit for an extended period of time (i.e., during the summer months), it is important that you follow these instructions to help prevent stagnation of water in the unit.

1. Clean your humidifier as instructed in the section titled "Cleaning and Maintenance."
2. Make sure all water is emptied from the water reservoir and water tray. Discard the wick filters (if they need to be replaced). For optimum performance, the wicks should be replaced a minimum of once per season or more often if the unit is used in hard water conditions.
3. Dry your unit thoroughly.
4. Leave the reservoir caps off the reservoirs, allowing them to be exposed to air.
5. Pack your humidifier in its original carton and store in a cool, dry place.
6. Order your replacement Wick Filter (Model 900) and Air Filter (Model 911D) by calling 1-800-788-5350 in North America, or through www.bionaire.com.

Troubleshooting for your Console Humidifier		
<u>Trouble</u>	<u>Probable Cause</u>	<u>Solution</u>
Unit not operating; Power light is not illuminated	<ul style="list-style-type: none"> ☛ Power cord is not properly connected to the unit and the power source. ☛ Power failure. 	<ul style="list-style-type: none"> ✓ Connect the power cord onto the unit and into the power source. ✓ Check circuit breaker or outlet.
Empty/"Refill" light is on.	<ul style="list-style-type: none"> ☛ Water reservoirs need refilling. ☛ Float is not correctly positioned. ☛ Unit is not level. ☛ Scale buildup on tray. 	<ul style="list-style-type: none"> ✓ Remove water reservoirs and refill. ✓ Carefully reposition float in the unit. ✓ Place unit on a level surface. ✓ Clean according to cleaning instructions.
Mist output minimal to none.	<ul style="list-style-type: none"> ☛ Wick filters have not absorbed water. ☛ Mineral buildup in tray. ☛ Digital Humidistat is set too low. 	<ul style="list-style-type: none"> ✓ Wait 30 minutes before starting humidifier. ✓ Remove tray, clean according to cleaning instructions. ✓ Set Humidistat higher if desired.

Troubleshooting for your Console Humidifier (Cont'd)

<u>Trouble</u>	<u>Probable Cause</u>	<u>Solution</u>
Mist output minimal to none (cont'd.).	<ul style="list-style-type: none">☛ Filter needs to be replaced.☛ Normal	<ul style="list-style-type: none">✓ Replace wick filter by visiting our website at www.bionaire.com or calling 1-800-788-5350.✓ Mist is invisible.
Unit is continuously operating while on the AUTO setting.	<ul style="list-style-type: none">☛ The Digital humidistat is set at a higher level than the present level of humidity in the room.	<ul style="list-style-type: none">✓ Reset the humidistat to a lower setting if desired.
Wick filter turns	<ul style="list-style-type: none">☛ Wick filter needs to be replaced.	<ul style="list-style-type: none">✓ Replace the wick filter by visiting our website at www.bionaire.com or calling 1-800-788-5350.

WARRANTY

Bionaire® warrants to the first retail purchaser, for TWO (2) YEARS from the date of original purchase, either to repair or replace at its option, without charge (parts and labor), any supplied or manufactured part of this humidifier which, upon inspection by an authorized service center, proves to have failed in normal use due to defects in material or workmanship, or, at its option, to replace the unit. Operation under conditions other than those recommended or at voltages other than the voltage indicated on the unit, or any attempts by unauthorized personnel to service the unit or modify it, will render the guarantee void. Bionaire® shall not be liable for any personal injury, property damage or any incidental or consequential damages of any kind (including water damage), resulting from defects, malfunctions, misuse, improper installation or alteration of the product.

BIONAIRE® EXPRESSLY DISCLAIMS ALL RESPONSIBILITY FOR CONSEQUENTIAL DAMAGES OR INCIDENTAL LOSSES CAUSED BY USE OF THIS PRODUCT.

The provisions of this warranty are in addition to, and not a modification of, or subtraction from the statutory warranties and other rights and remedies contained in any applicable legislation and to the extent that any such provision purports to disclaim, exclude or limit any such statutory warranties or other rights or remedies, such provisions shall be deemed to be amended to the extent necessary to comply therewith.

For Warranty Service, please call 1-800-788-5350 in North America.

A Bionaire® consumer service representative will help determine which is the best procedure in order for your humidifier to be repaired.

KEEP THIS NUMBER FOR FUTURE REFERENCE.