

This Owner's Manual is provided and hosted by [Appliance Factory Parts](#).



Broil-Mate 1930-4 Owner's Manual

[Shop genuine replacement parts for Broil-Mate 1930-4](#)



[Find Your Broil-Mate Grill Parts - Select From 682 Models](#)

----- Manual continues below part list -----

Available Replacement Parts for Broil-Mate 1930-4

03200	spark generator; Bmstr, DCS, Ducane
14625	warming rack universal, 15 x 6.5
10696-160	ORIFICE HOOD R/B 0.160MM NG
18627GC	BURNER, DUAL 50,000 BTU
10892-8NG	WHEEL 8 INCH GREY WALL
03230	spark generator; Ducane
18488	FLAV-R-WAVE - 50,000 BTU STAINLESS
S15500	IGNITOR ELECTRODE ASSY H B H BURNER
18013	LARGE PROBE HEAT INDICATOR
10184-K581	SHELF SUPPORT LFT BLK
10184-K591	SHELF SUPPORT RH BLK
10184-R19	TANK RETAINER-PEDESTAL-NEW
10225-T10	GRID PORCELAIN S/B
10393-K40	SIDE BURNER COVER 1.86
10892-15	CASTER 2 1/2 INCH WHEEL KNURLED
S15171	AXLE PLTD 3/8x18 9/16 PED +
S21124	SCREW PHCP #8 X 12 +
PB20-60A	S/B LID HANDLE WAGON ENCLOSER+ W/SCREWS
10390-E10	BURNER SIDE 10BTU W/ELEC #8 +
10342-T14	WIRE ELECTRODE S/B FLAT/ROUND+
10393-R50	SIDE BURNER BODY 2002 +
10442-R54	CONTROL ASSEMBLY 75M 4V LP 2842
10239-7	HANDLE GASKET TRIANGULAR 1/8
50416	SMALL DRIP PAN - 10 PACK
S14019	NAMEPLATE BROILMATE LG FLSH +
S11426	BOTTOM CASTING R/B + 2500/2700/400/700
S11250	CASTING TOP +
10086-R731	DECO PANEL SS 1900 4VSB
02342	control knob; universal
10696-109	ORIFICE HOOD R/B 0.109MM LP

10184-R80	RADIATION SHIELD RAW
30260130	SHELF SIDE REV A +
11228	CI COOKING GRIDS SET OF 2
10472-k40	KNOB ROTARY IGNITOR #B
CG21SS	Cooking Grid Stainlss st Warm Morning G4
80012	regulator and hose READ ADD. INFO
S12206	WARMING RACK 2500 1998 +
10958-E71	PEDESTAL RESIN BASE LRG +
10111-K45	HOSE 3/8 INCH ASSEMBLY NG 10 FOOT +
Y-11990	NUT HEX BRASS 3/8 27 RB LINE

broil-mate™

REDDI- BILT BARBECUES

ASSEMBLY MANUAL & PARTS LIST

MANUEL DE MONTAGE & LISTE DE PIÈCES

broil-mate™
1910-4
1910-7



broil-mate™
1919-4
1919-7



broil-mate™
1917-4
1917-7



broil-mate™
1929-4
1929-7



broil-mate™
1930-4
1930-7



broil-mate™
1940-4
1940-7



broil-mate™
1949-4
1949-7





RETAIN FOR FUTURE REFERENCE

VEUILLEZ CONSERVER POUR REFERENCE ULTERIEURE

1

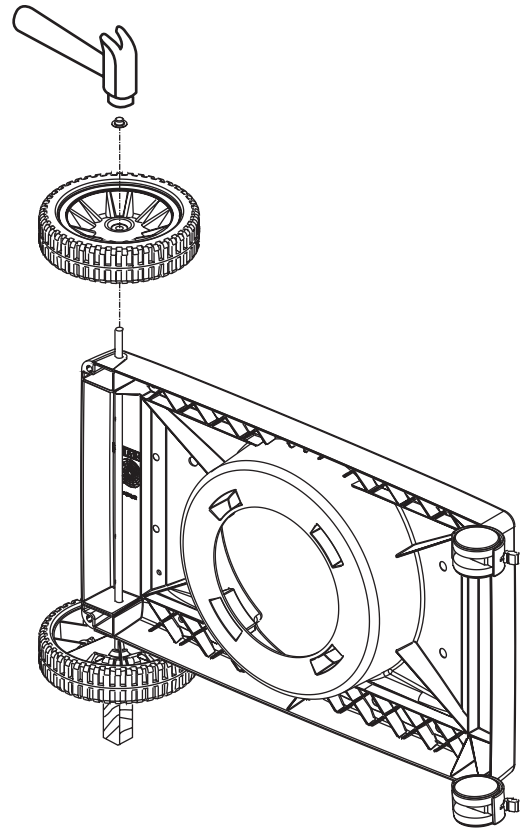
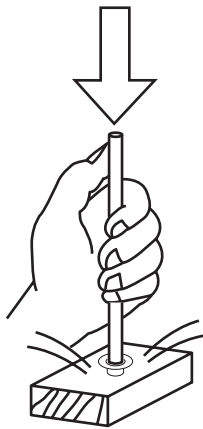
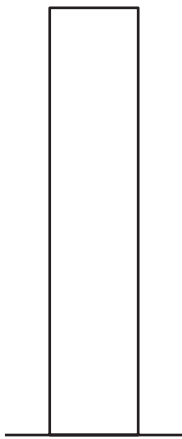
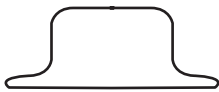
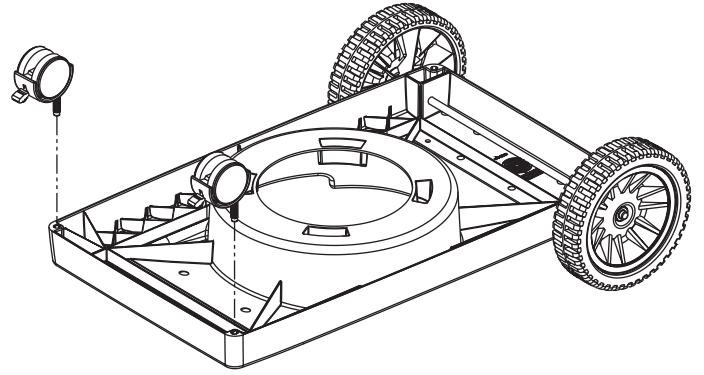
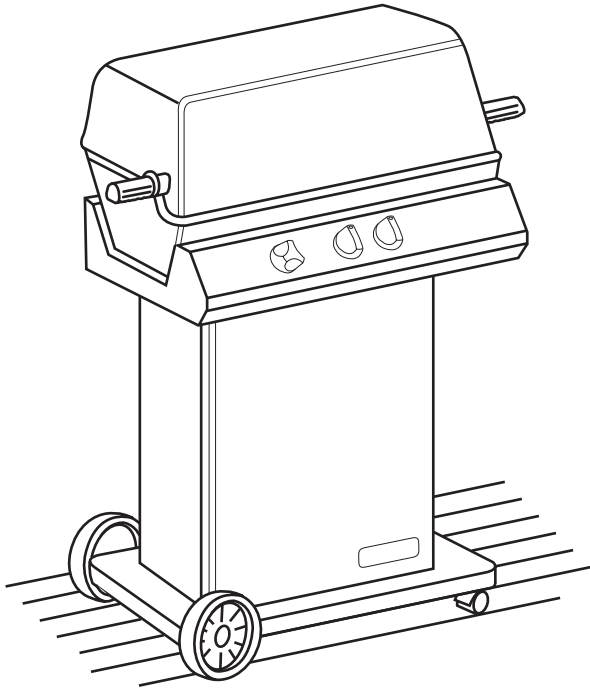
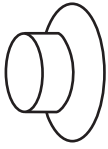
(2)



2

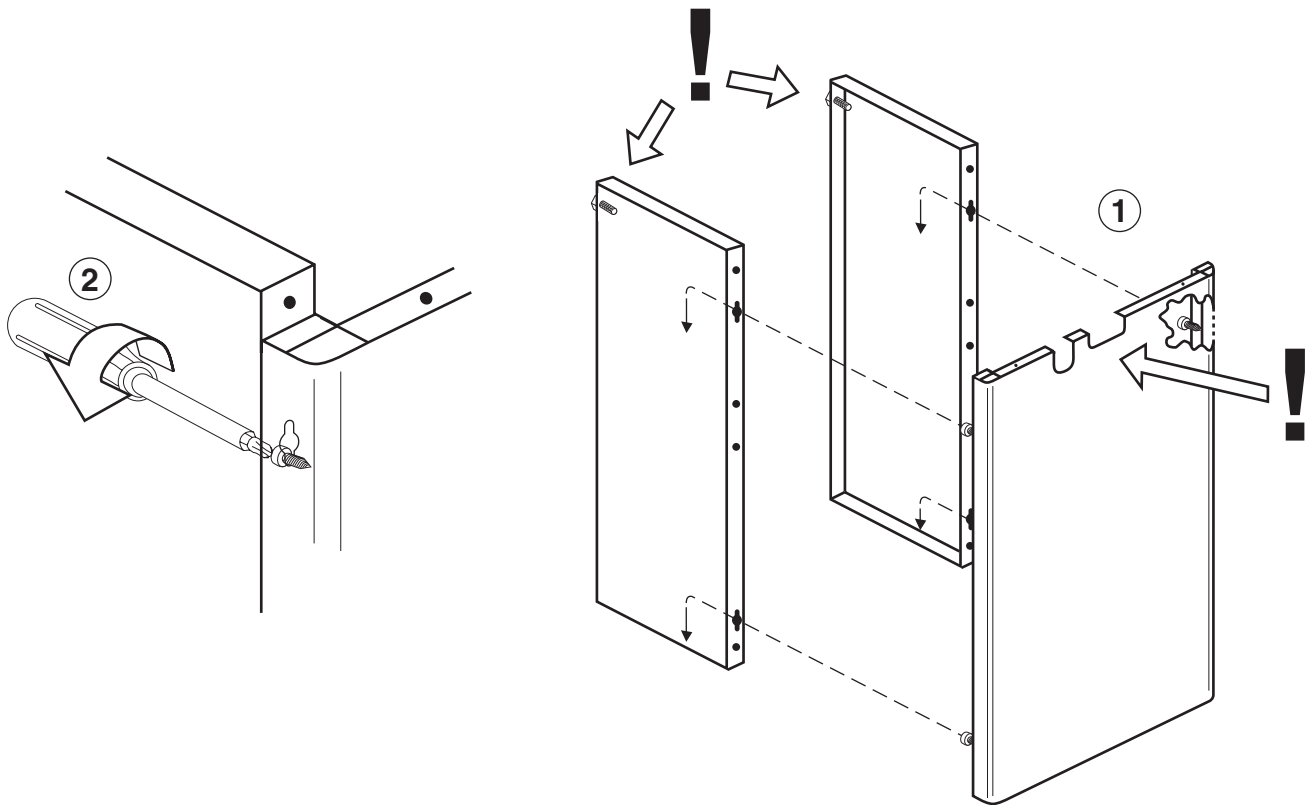

3

(6)

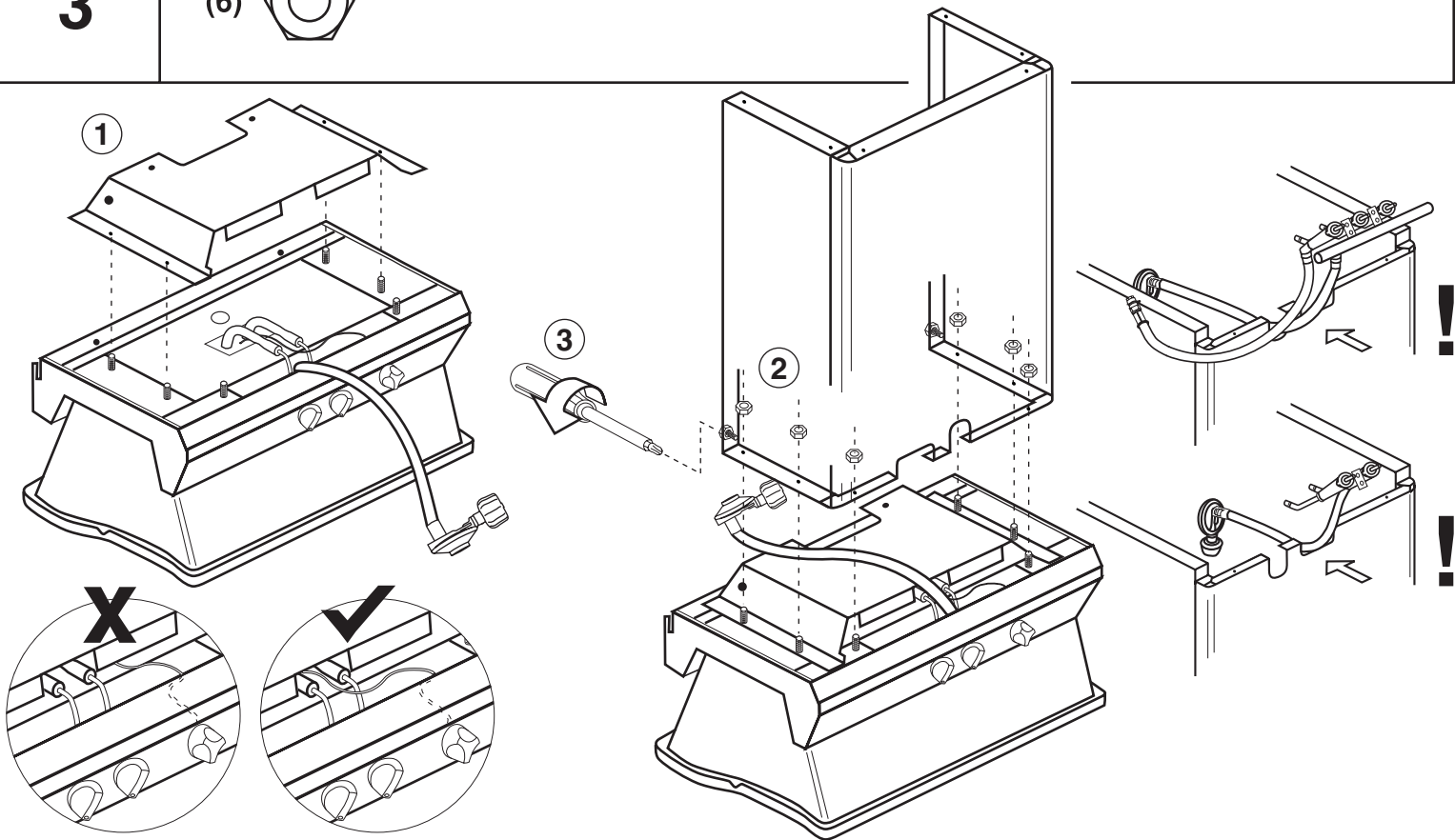

4

(8)



(8)

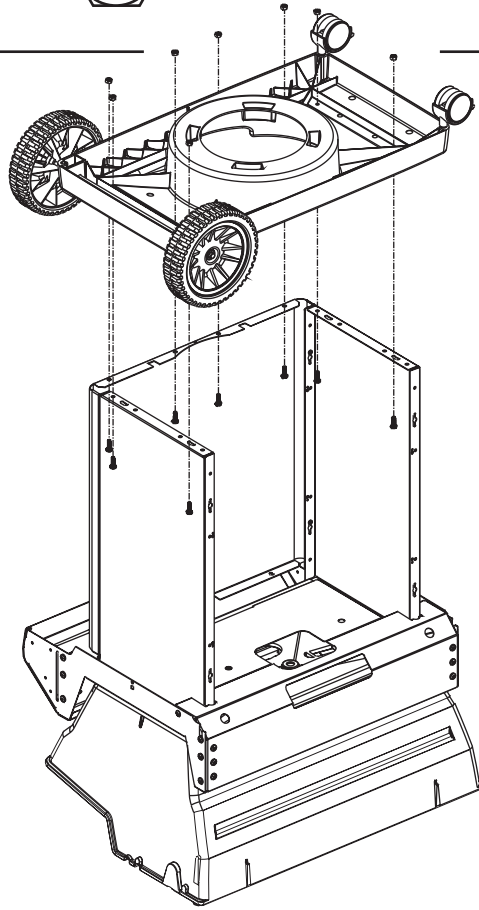

5

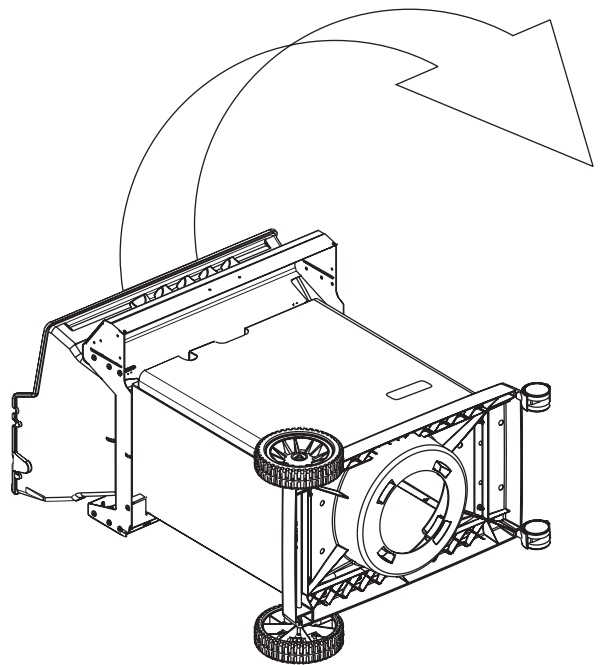
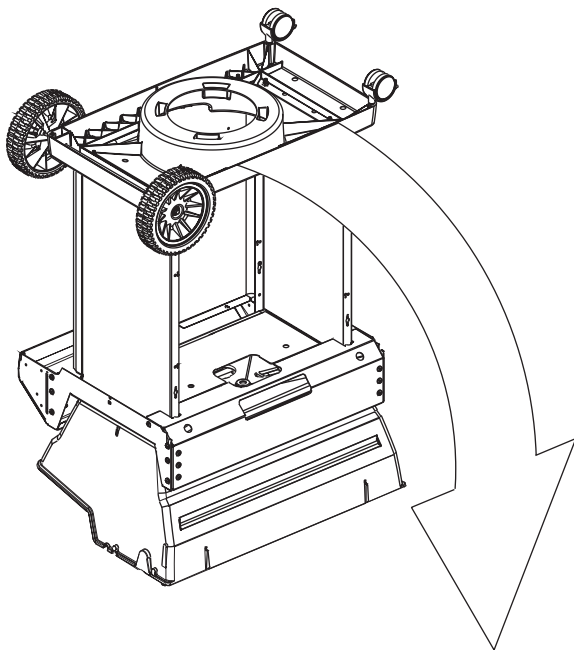

6

(2) 

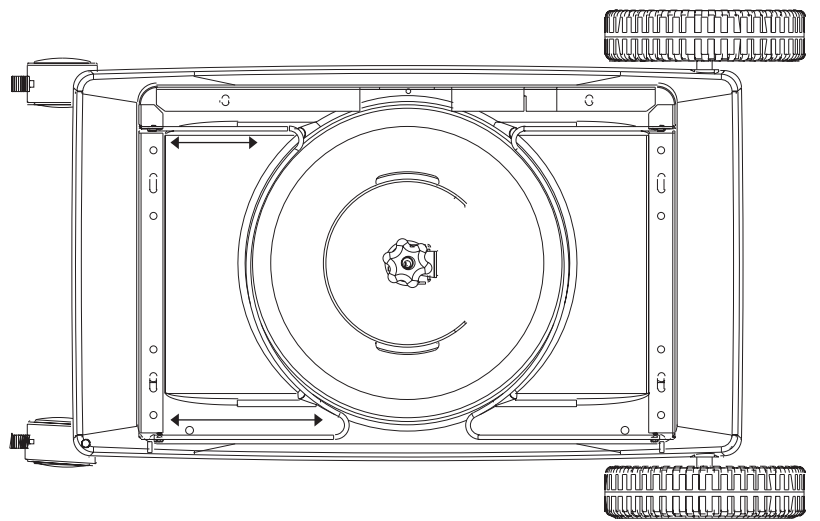
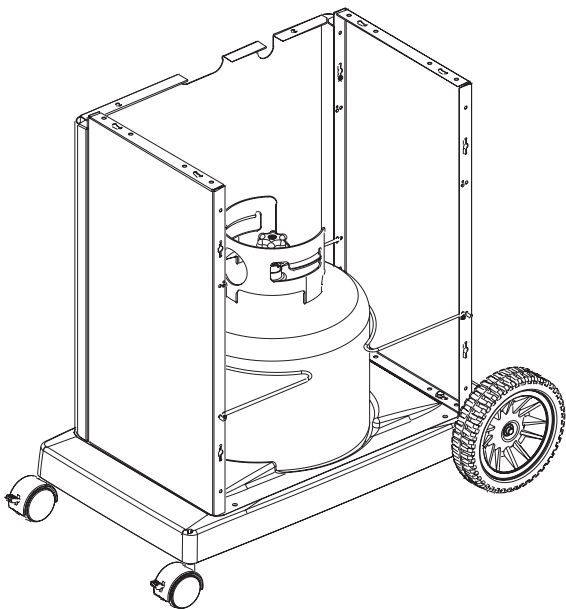
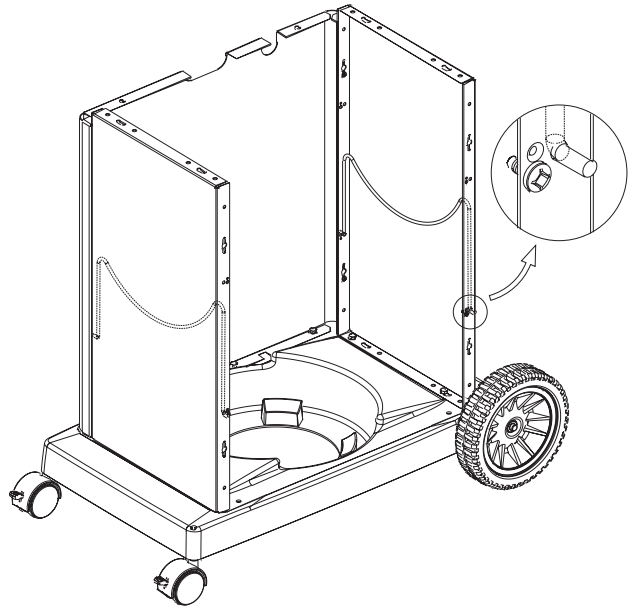
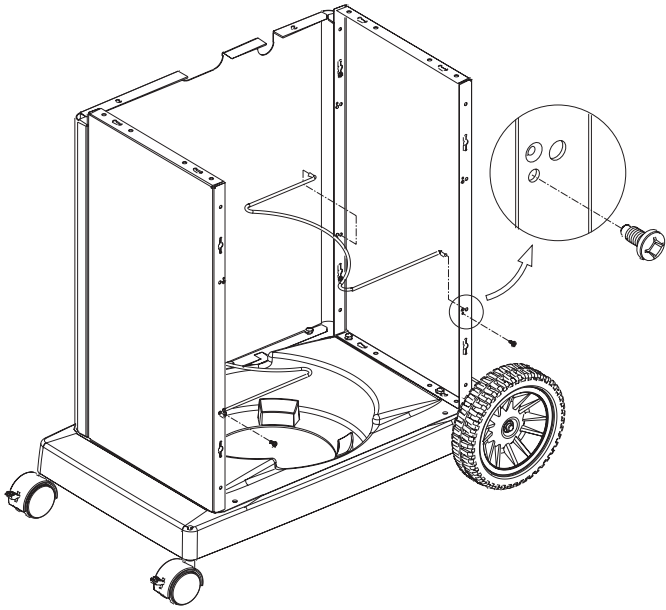

7

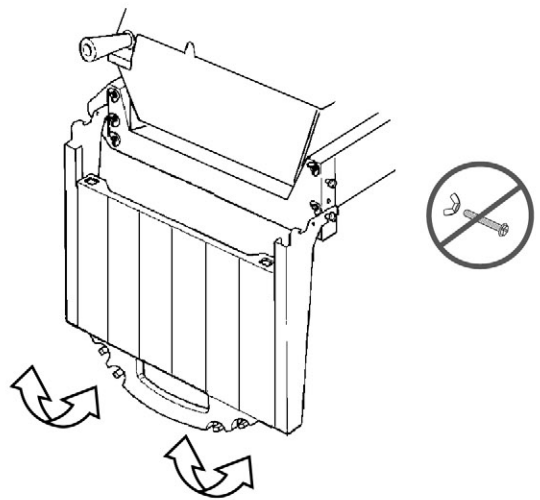
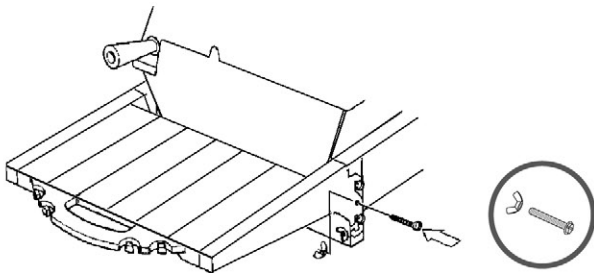
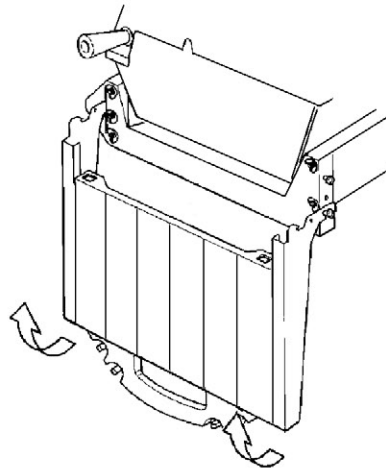
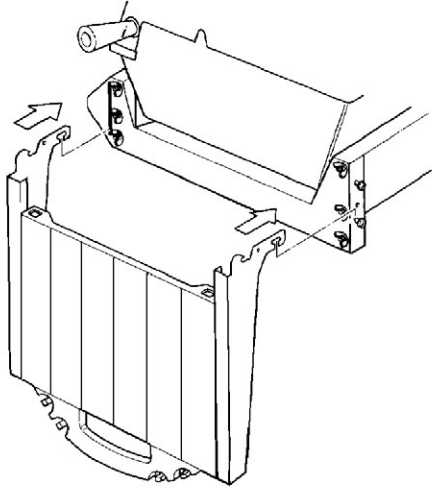
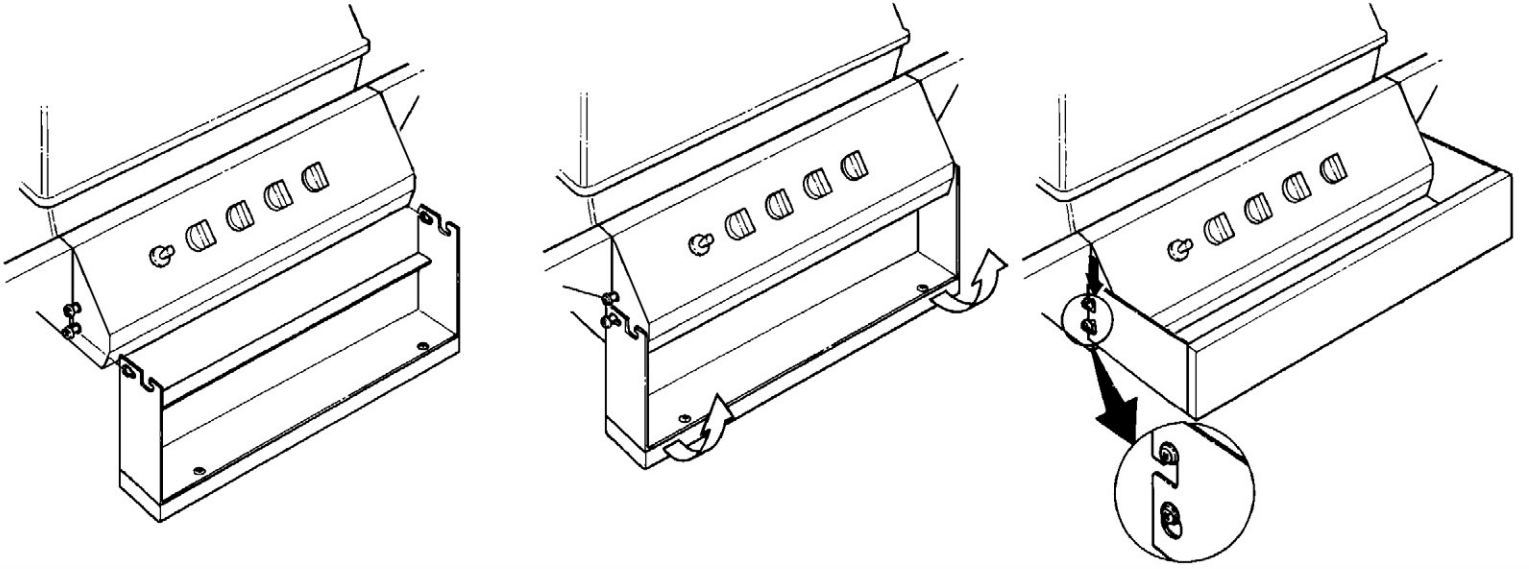
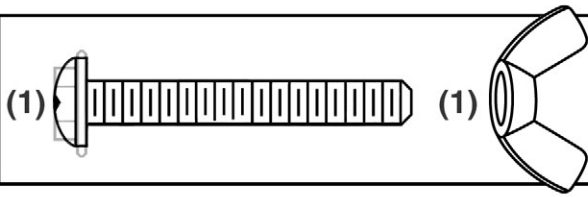

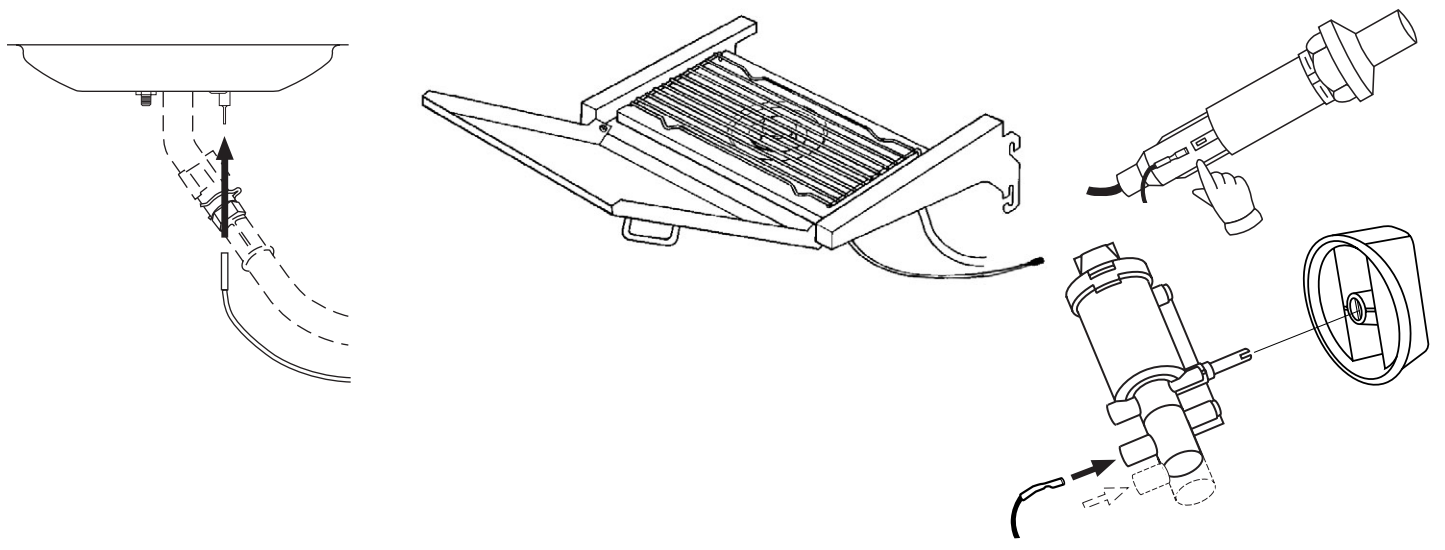
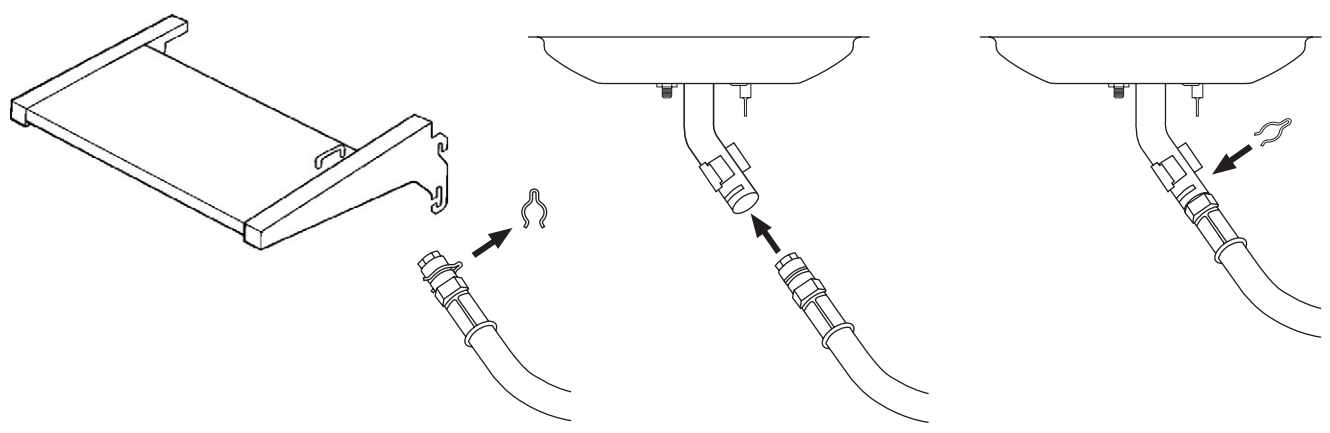
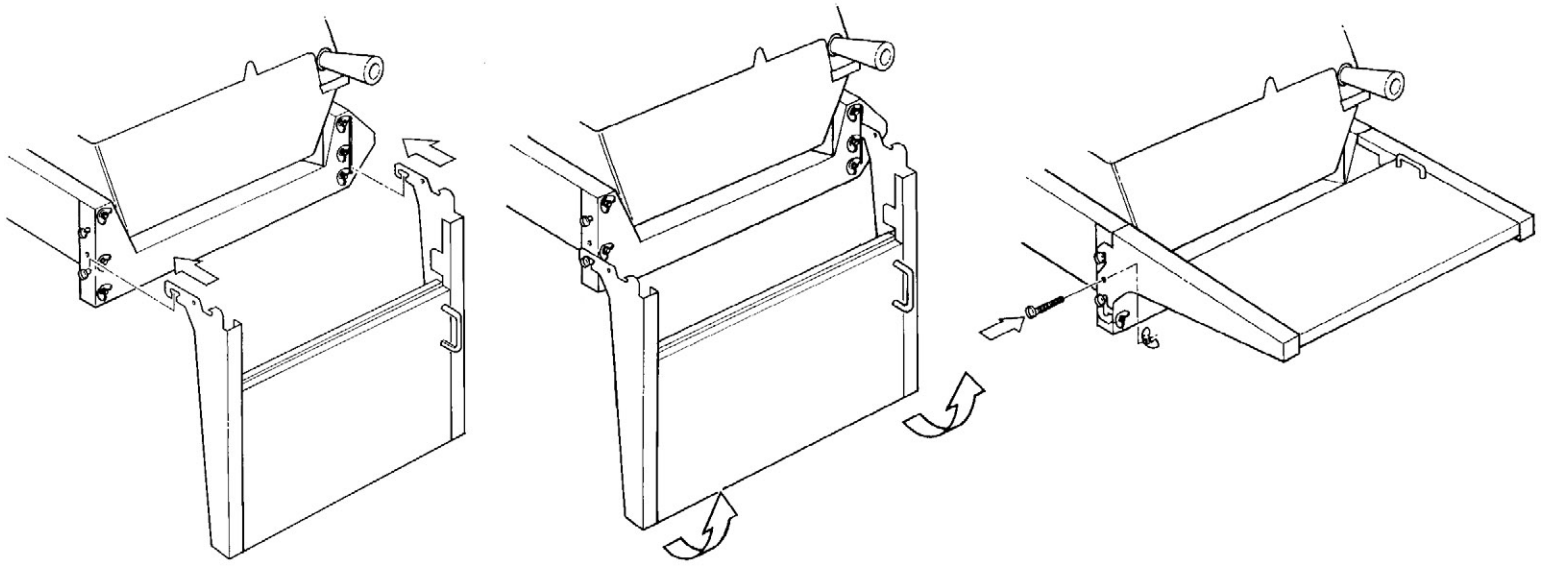
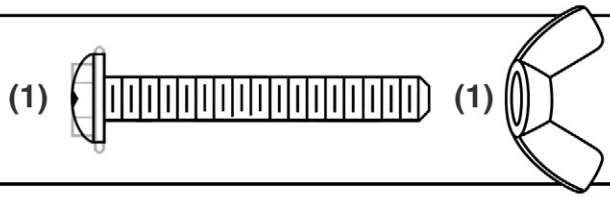

8

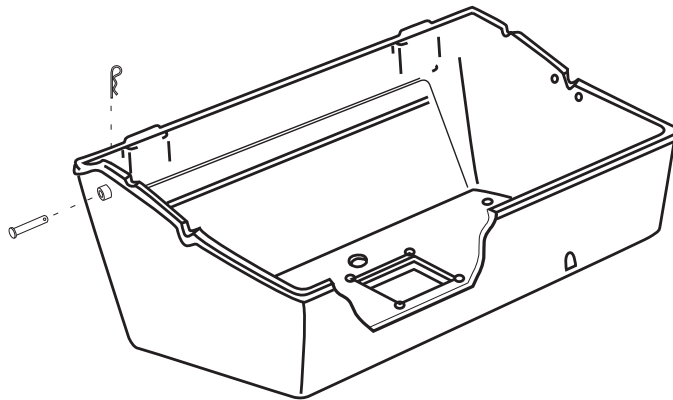
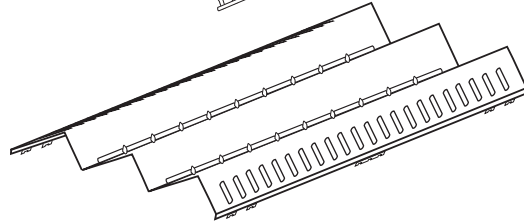
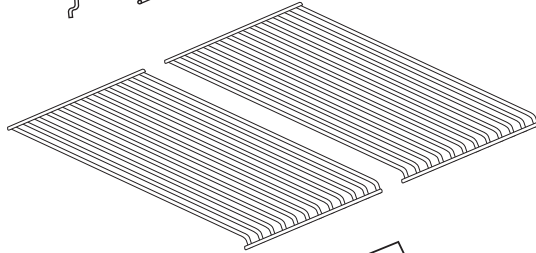
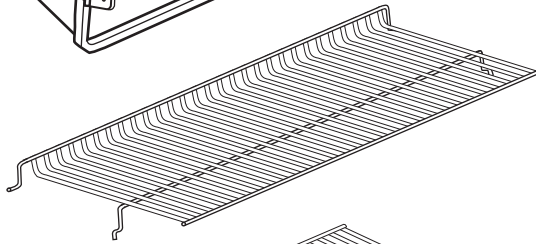
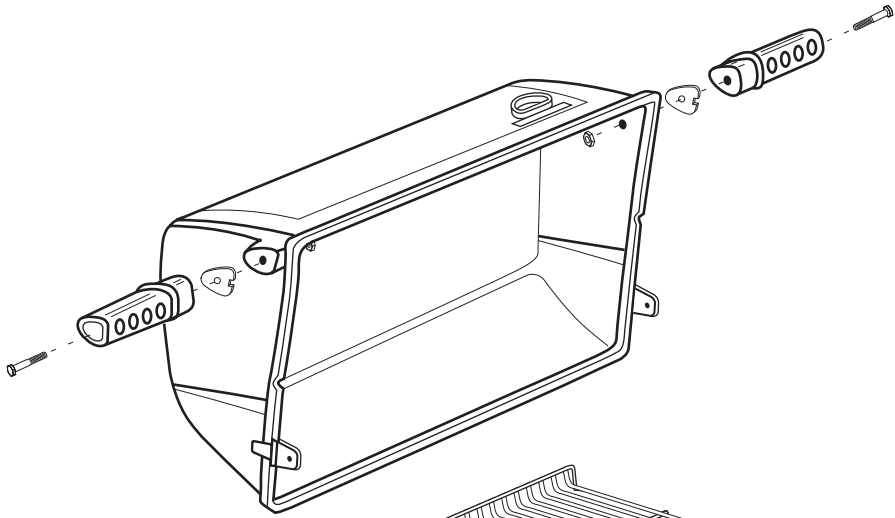
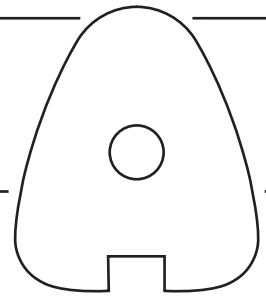
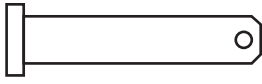

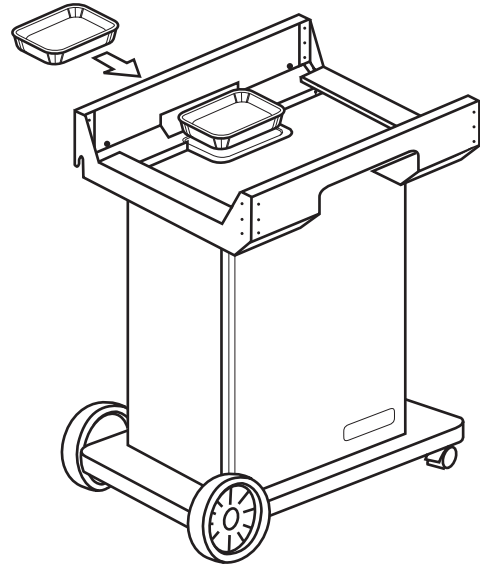
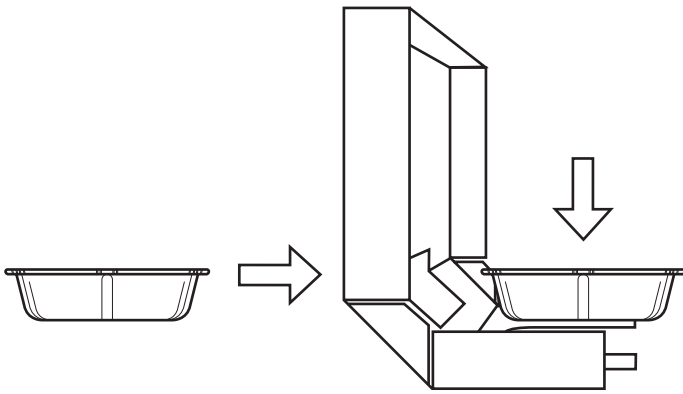
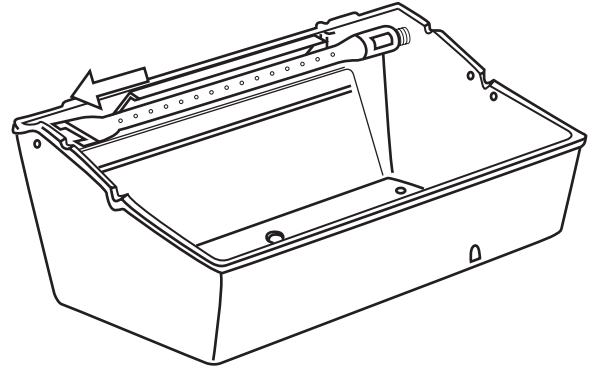
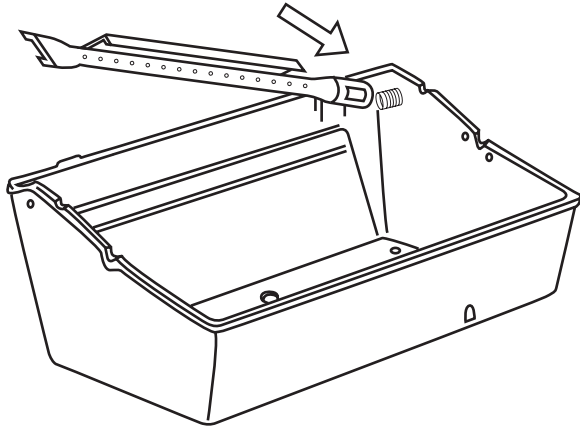

PARTS LIST / LISTE DES PIECES

KEY #	ITEM #	DESCRIPTION	DESCRIPTION	1910		1917		1919		1929		1930		1940		1949		
				-4	-7	-4	-7	-4	-7	-4	-7	-4	-7	-4	-7	-4	-7	
1	S11425	CASTING BOTTOM	FOND DU FOYER	1	1	1	1	1	1	1	1	1	1	1	1	1	1	
2	S11250	CASTING TOP	COUVERCLE DU GRIL	1	1	1	1	1	1	1	1	1	1	1	1	1	1	
3	S14019	NAMEPLATE	PLAQUE D'IDENTIFICATION	1	1	1	1	1	1	1	1	1	1	1	1	1	1	
3A.	S14016	NAMEPLATE	PLAQUE D'IDENTIFICATION	1	1	1	1	1	1	1	1	1	1	1	1	1	1	
4	10958-K69	LID INSERT	PANNEAU DE COUVERCLE	1	1	1	1	1	1	1	1	1	1	1	1	1	1	
5	10571-6	HEAT INDICATOR	INDICATEUR DE CHALEUR	1	1	1	1	1	1	1	1	1	1	1	1	1	1	
6	S21235	HINGE PIN	CHEVILLE DE CHARNIERE	2	2	2	2	2	2	2	2	2	2	2	2	2	2	
7	S21233	HINGE CLIP	ATTACHE DE CHEVILLE	2	2	2	2	2	2	2	2	2	2	2	2	2	2	
8	10222-T424	FLAV-R-WAVE – PORCELAIN	FLAV-R-WAVE - PORCELAIN	1	1	•	•	1	1	1	1	1	1	1	1	•	•	
	10222-T425	FLAV-R-WAVE – S.S.	FLAV-R-WAVE – AI	•	•	1	1	•	•	•	•	•	•	•	•	•	1	1
9	S12029	GRID	GRILLE	2	2	•	•	2	2	2	2	2	2	2	2	•	•	
	S12024	GRID – S.S.	GRILLE – AI	•	•	2	2	•	•	•	•	•	•	•	•	2	2	
11	S12206	GRID RETRACTABLE	GRILLE RETRACTABLE	•	•	1	1	•	•	•	•	•	•	•	•	•	•	
	S12207	GRID RETRACTABLE	GRILLE RETRACTABLE	1	1	•	•	1	1	1	1	•	•	1	1	1	1	
15	S10017	BURNER ASSY	ENSEMBLE DE BRULEUR	1	1	1	1	1	1	1	1	1	1	1	1	1	1	
17	10342-242	IGNITOR	ALLUMEUR	1	1	1	1	1	1	•	•	1	1	•	•	•	•	
	10342-243	IGNITOR	ALLUMEUR	•	•	•	•	•	•	1	1	•	•	1	1	1	1	
	10472-K40	KNOB – ROTARY	BOUTON – ROTATIF	1	1	1	1	1	1	1	1	1	1	1	1	1	1	
18	S15500	ELECTRODE	ELECTRODE	1	1	1	1	1	1	1	1	1	1	1	1	1	1	
21	10440-K50	CONTROL ASSY LP	SOUPAPE, (GAZ PROPANE)	1	•	1	•	1	•	1	•	•	•	•	•	•	•	
	10440-K51	CONTROL ASSY NG	SOUPAPE, (GAZ NATUREL)	•	1	•	1	•	1	•	1	•	•	•	•	•	•	
	10442-K52	CONTROL ASSY LP	SOUPAPE, (GAZ PROPANE)	•	•	•	•	•	•	1	•	•	•	•	•	•	•	
	10440-R52	CONTROL ASSY LP	SOUPAPE, (GAZ PROPANE)	•	•	•	•	•	•	•	•	1	•	•	•	•	•	
	10440-R53	CONTROL ASSY NG	SOUPAPE, (GAZ NATUREL)	•	•	•	•	•	•	•	•	•	1	•	•	•	•	
	10442-R54	CONTROL ASSY LP	SOUPAPE, (GAZ PROPANE)	•	•	•	•	•	•	•	•	•	•	1	•	1	•	
	10442-R55	CONTROL ASSY NG	SOUPAPE, (GAZ NATUREL)	•	•	•	•	•	•	•	•	•	•	•	1	•	1	
21A.	S13467-091	HOSE – SIDE BURNER LP	TUYAU DU BRULEUR LATERAL PL	•	•	•	•	•	•	1	•	•	•	•	1	1	1	
	S13467-132	HOSE – SIDE BURNER NG	TUYAU DE BRULEUR LATERAL GN	•	•	•	•	•	•	•	1	•	•	•	1	1	1	
	Y-11230	COTTER PIN	ATTACHE DE CHEVILLE	•	•	•	•	•	•	1	1	•	•	1	1	1	1	
21B.	10110-93	HOSE – REARBURNER	TUYAU DE BRULEUR ARRIERE	•	•	•	•	•	•	•	•	1	1	1	1	1	1	
22	10114-20	HOSE & REGULATOR LP – QCC1	TUYAU ET REGULATEUR PL – QCC1	1	•	1	•	1	•	1	•	1	•	1	•	1	•	
	10111-K47	HOSE NATURAL GAS	TUYAU (GAZ NAUTREL)	•	1	•	1	•	1	•	1	•	1	•	1	•	1	
23	10472-K37	CONTROL KNOB	BOUTON DE CONTROLE	2	2	2	2	2	2	3	3	3	3	4	4	4	4	
30	10086-R70	DECO PLATE	PLAQUE DECORATIVE	•	•	•	•	•	•	•	•	1	1	•	•	•	•	
	10086-R701	DECO PLATE	PLAQUE DECORATIVE	1	1	1	1	1	1	•	•	•	•	•	•	•	•	
	10086-R711	DECO PLATE	PLAQUE DECORATIVE	•	•	•	•	•	•	1	1	•	•	•	•	•	•	
	10086-R731	DECO PLATE	PLAQUE DECORATIVE	•	•	•	•	•	•	•	•	•	•	1	1	1	1	
31	10194-R561	CONTROL COVER	PANNEAU DE CONTROLE	1	1	1	1	1	1	1	1	1	1	1	1	1	1	
33	10184-R801	RADIATION SHIELD	ECRAN DE CHALEUR	1	1	1	1	1	1	1	1	1	1	1	1	1	1	
35	10184-R561	SUPPORT – CASTING – LEFT	SUPPORT GAUCHE DU FOYER	1	1	1	1	1	1	1	1	1	1	1	1	1	1	
36	10184-R571	SUPPORT – CASTING – RIGHT	SUPPORT DROIT DU FOYER	1	1	1	1	1	1	1	1	1	1	1	1	1	1	
37	10184-K581	SUPPORT – SIDE SHELF – LH	SUPPORT TABLETTE DE GAUCHE	2	2	2	2	2	2	2	2	2	2	2	2	2	2	
38	10184-K591	SUPPORT – SIDE SHELF – RH	SUPPORT TABLETTE DE DROITE	2	2	2	2	2	2	2	2	2	2	2	2	2	2	
39	10958-R831	BRACE – UPPER REAR	SUPPORT ARRIERE	1	1	1	1	1	1	1	1	1	1	1	1	1	1	
40	10958-R81	SHELF – LOWER	TABLETTE INFERIEURE	1	1	1	1	1	1	1	1	1	1	1	1	1	1	
41	10958-K851	POST – FRONT BRACE	POTEAU-SUPPORT AVANT	1	1	1	1	1	1	1	1	1	1	1	1	1	1	
42	10958-K881	POST – FRONT PANEL	POTEAU-SUPPORT AVANT	1	1	•	•	•	•	•	•	1	1	1	1	•	•	
	10958-K89	POST – FRONT PANEL –S.S.	POTEAU-SUPPORT AVANT	•	•	1	1	1	1	1	1	•	•	•	•	1	1	
43	10958-R861	POST – SIDE PANEL	POTEAU-PANNEAU LATERALE	2	2	2	2	2	2	2	2	2	2	2	2	2	2	
47	10184-R19	TANK RETAINER	SERVITEUR DU RESERVOIR PL	2	•	2	•	2	•	2	•	2	•	2	•	2	•	
49	10711-K541	CONDI-BIN	CONDI-BIN	1	1	1	1	1	1	1	1	1	1	1	1	1	1	
50	10711-K551	SHELF – SIDE	PLANCHETTE LATERALE	2	2	•	•	2	2	•	•	1	1	1	1	•	•	
	10711-K70	SHELF – SIDE S.S.	PLANCHETTE LATERALE	•	•	2	2	•	•	1	1	•	•	•	•	1	1	
53	S16144	SHELF BOARD – FRONT	PLANCHETTE AVANT	1	1	1	1	1	1	1	1	1	1	1	1	1	1	
56	10892-8	WHEEL	ROUE	2	2	2	2	2	2	2	2	2	2	2	2	2	2	
65	S13009	BURNER ROTISSERIE	BRULEUR A ROTISS	•	•	•	•	•	•	•	•	1	1	1	1	1	1	
68	S21362	SPRING	RESSORT	•	•	•	•	•	•	•	•	1	1	1	1	1	1	
70	Y-11990	HEX NUT	ECROU	•	•	•	•	•	•	•	•	1	1	1	1	1	1	

