

Aussie Adventurer™



PORTABLE LP Gas Grill

Pre-Assembled Grill

Owner's and Use Manual

This Owners Manual for use with Models:

2400 with Side Table

2410 with Side Burner

2420 with Side Table and Lantern

2430 with Side Burner and Lantern

2440 with Side Burner, Lantern and Carry Bag

MODEL 2430 shown
(LP Cylinders not included)



FOR OUTDOOR HOUSEHOLD USE ONLY. NOT FOR COMMERCIAL USE.

For Customer Service, call 1-800-251-7558 or visit our website at www.meco.net

⚠ WARNING

- Failure to follow these instructions could result in fire or explosion which could cause death, serious personal injury, or property damage.
- Read and follow instructions carefully before assembly or use.
- **Do not** use this product for any other purpose than which it is intended.
- These instructions must be kept with the user. **SAVE THESE INSTRUCTIONS.**

FOR YOUR SAFETY

If you smell gas:

1. Do not attempt to light appliance.
2. Extinguish any open flame.
3. Disconnect from fuel supply.

FOR YOUR SAFETY

1. Do not store or use gasoline or other flammable vapors and liquids within 25 feet (7.62m) of this or any other appliance.
2. An LP cylinder not connected for use shall not be stored within 10 feet (3.05m) in the vicinity of this or any other appliance.
3. Do not store any LP gas cylinder indoors.

CONTENTS

<p>I. Assembly Instructions.....2</p> <p> A) Parts Illustrations.....3</p> <p> B) Parts List.....4</p> <p> C) Setting up Your Grill.....5</p> <p> 1) Standing Grill On Legs.....5</p> <p> 2) Side Table Assembly.....7</p> <p> 3) Side Burner Table Assembly.....7</p> <p> 4) Lantern Assembly.....8</p> <p> a) Assemble Mantle to Burner.....8</p> <p> b) Pre-burn Mantle.....8</p> <p> c) Assemble Lantern to Gas Tube.....9</p> <p> d) Assemble Lantern/Gas Tube to Grill.....9</p> <p> 5) Install Grease Container.....9</p> <p> D) Connecting/Disconnecting LP Cylinder.....10</p> <p> 1) Installation Codes.....10</p> <p> 2) LP Cylinder.....10</p> <p> 3) Hoses & Regulator.....10</p> <p>II. Operating and Maintaining Your LP Gas Grill.....11</p> <p> A) Before Using Your Grill.....11</p> <p> 1) Using Gas.....11</p> <p> 2) Selecting a Location.....11</p>	<p> 3) Performing a Leak Test.....12</p> <p> B) Lighting the Gas Grill.....13</p> <p> 1) Ignition Lighting Main Grill.....13</p> <p> 2) Manual Lighting Main Grill.....13</p> <p> 3) Ignition Lighting the Side Burner.....14</p> <p> 4) Manual Lighting the Side Burner.....14</p> <p> 5) Ignition Lighting the Lantern15</p> <p> 6) Manual Lighting the Lantern15</p> <p> 7) Check Your Flame.....15</p> <p> C) Operating the Gas Grill.....16</p> <p> 1) Grill Cooking.....16</p> <p> 2) End of Cooking Session.....17</p> <p> D) Care and Maintenance.....17</p> <p> 1) Cleaning the Grill.....17</p> <p> a) Grease Container...17</p> <p> b) Cooking Grid.....17</p> <p> c) Hood and Bowl.....17</p> <p> d) Burners.....17</p> <p> 2) Storage and Transport.....19</p> <p>III. Troubleshooting.....20</p> <p>V. Limited Warranty.....22</p>
--	---

— NOTICE —

MECO CORPORATION STRIVES TO BE A QUALITY SUPPLIER OF CONSUMER PRODUCTS. IF WE OMITTED ANY PARTS NEEDED FOR ASSEMBLY, OR YOU NEED TROUBLESHOOTING INFORMATION, PLEASE CONTACT US USING OUR TOLL FREE NUMBER. THANK YOU FOR PURCHASING A MECO CORPORATION PRODUCT.

1-(800)-251-7558
 8 am - 6 pm E.S.T Mon. - Fri.
 1-(423)-639-1171 (TELEPHONE)
 1-(423)-639-2570 (FAX)

www.meco.net

CONSUMER SERVICE DEPARTMENT
 MECO CORPORATION
 1500 INDUSTRIAL ROAD
 GREENEVILLE, TN. 37745 USA

⚠ DANGER



CARBON MONOXIDE HAZARD

This appliance can produce carbon monoxide which has no odor.

Using it in an enclosed space can kill you.

Never use this appliance in an enclosed space, such as a camper, tent, car or home.

ASSEMBLY INSTRUCTIONS

⚠ WARNING

- To reduce the risk of serious bodily injury or death:**
- The use of alcohol, prescription or non-prescription drugs could impair the consumer's ability to properly assemble or safely operate this appliance.
 - Do not connect LP cylinders until assembly is complete.

PREPARATION FOR ASSEMBLY: **Note:** This Grill is **pre-assembled**. Only the accessory items need to be attached. Remove Grill and all the packaging from carton and place on floor. Make sure there are no loose parts. **Note:** **Before using your grill, read the instructions and your manual.** For easier set-up assembly, follow instructions of each step in the order they are written as you look at the diagrams. If your model grill does not have the accessories indicated in the assembly steps, skip that step and proceed to the next step that applies to your model.

If you need replacement parts, look in the Parts List Section to find the exact parts you need. If you have any questions or need help, contact our Customer Service. Be sure to mention the grill model number located on right side of the grill body.

Parts Replacement Illustrations

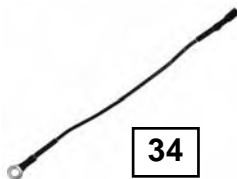
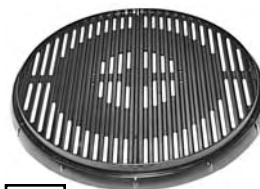
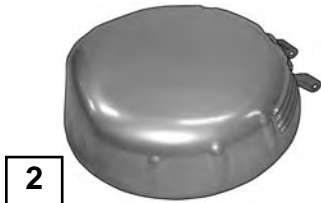

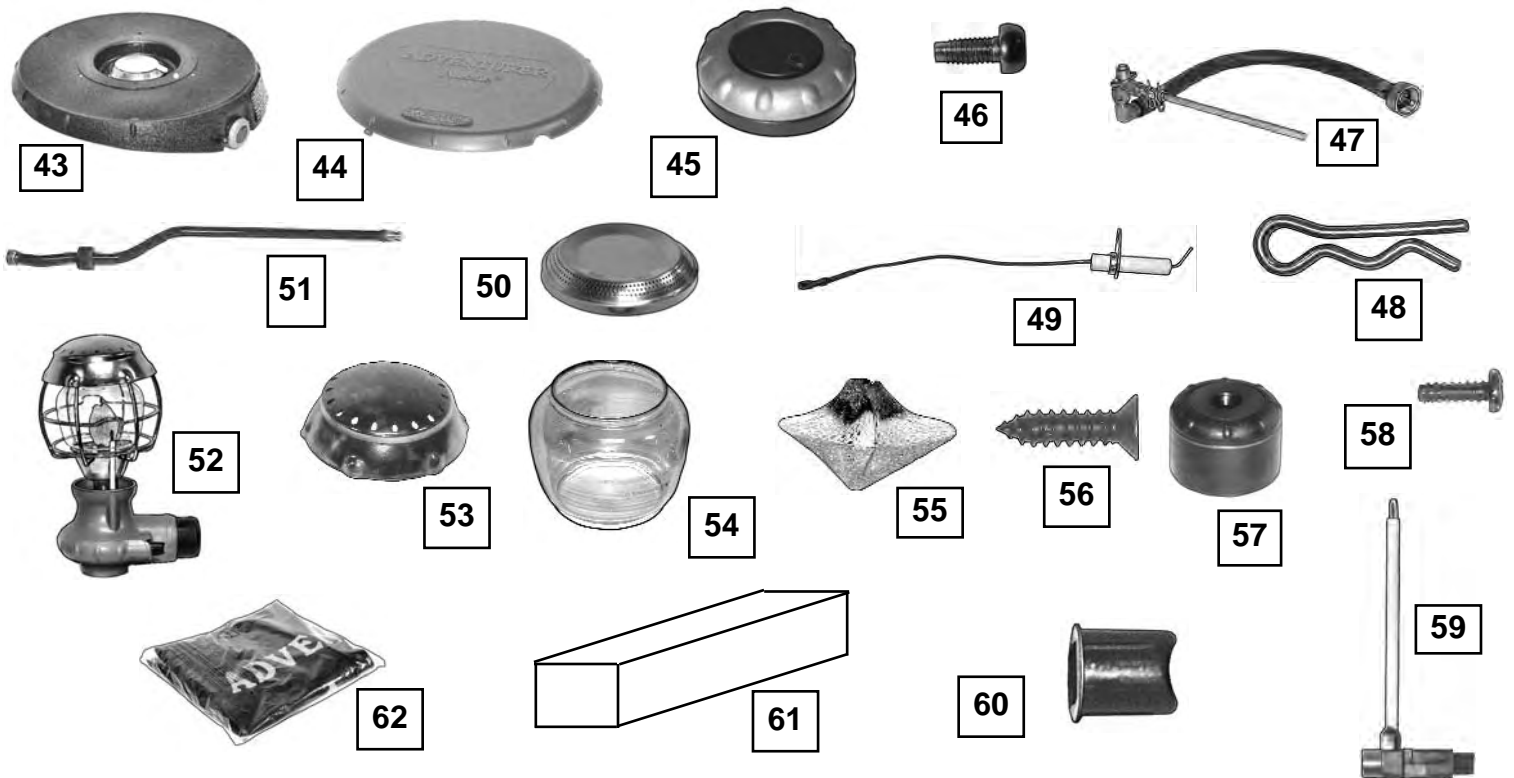

PARTS LIST			QTY				
			MODEL 2400	MODEL 2410	MODEL 2420	MODEL 2430	MODEL 2440
ITEM	DESCRIPTION	PART #					
1	Owner's Manual	03.6506.00	1	1	1	1	1
2	Hood w/Hinges	03.6506.01	1	1	1	1	1
3	Screw, M6x9 Shoulder (Hood Hinge)	03.6506.02	2	2	2	2	2
4	Hinge, Hood	03.6506.03	1	1	1	1	1
5	Screw, M5x10mm (Hood Hinge Bracket)	03.6237.00	3	3	3	3	3
6	Nut, M5 Hex Washer Head (Hood Hinge)	03.6506.04	3	3	3	3	3
7	Screw, M5x15 (Hood Handle)	03.6506.05	2	2	2	2	2
8	Hood Handle	03.6506.06	1	1	1	1	1
9	Hood Badge	03.6506.07	1	1	1	1	1
10	Hood Latch	03.6506.08	1	1	1	1	1
11	Screw, M5x12mm (Upper Leg)	03.6506.09	6	6	6	6	6
12	Bracket, Leg	03.6506.10	3	3	3	3	3
13	Screw, ST4.8 x 25mm Type A (Leg Bracket)	03.6506.11	9	9	9	9	9
14	Assy, Leg Bracket Assy	03.6506.12	3	3	3	3	3
15	Assy, Leg	03.6506.13	3	3	3	3	3
16	Screw, ST4.8x10mm Type B (Leg/Bowl Bracket)	03.6506.14	20	20	20	20	20
17	Screw, ST4.8x10mm Type A (Leg Lock)	03.6506.15	6	6	6	6	6
18	Leg Lock	03.6506.16	3	3	3	3	3
19	Leg Foot	03.6506.17	3	3	3	3	3
20	Screw, ST4.8x45mm Type B (Leg Foot)	03.6506.18	3	3	3	3	3
21	Bowl Pan	03.6506.19	1	1	1	1	1
22	Post Support, Bowl Pan	03.6506.20	4	4	4	4	4
23	Grease Container	03.6506.21	1	1	1	1	1
24	Cooking Grid	03.6506.22	1	1	1	1	1
25	Bracket, Body Hinge Bracket	03.6506.23	1	1	1	1	1
26	Body/Leg Assembly	03.6506.24	1	1	1	1	1
27	Screw, M6x15mm (Body Carry Handle)	03.6506.25	2	2	2	2	2
28	Handle, Body Carry	03.6506.26	1	1	1	1	1

ITEM	DESCRIPTION	PART #	QTY				
			MODEL 2400	MODEL 2410	MODEL 2420	MODEL 2430	MODEL 2440
29	Heat Shield	03.6506.27	1	1	1	1	1
30	Screw, ST3.8x6mm (Heat Shield)	03.6506.28	2	2	2	2	2
31	Guide Bracket, Main Burner	03.6506.29	1	1	1	1	1
32	Screw, M4x10mm (M. Burner/S. Burner Electrode)	03.6506.30	4	4	4	4	4
33	Main Burner	03.6506.31	1	1	1	1	1
34	Wire, Main Burner Ground	03.6506.32	1	1	1	1	1
35	Nut, M4 Hex (Main Burner/Ground Wire)	03.6506.33	2	2	2	2	2
36	Piezo	03.6260.01	1	2	1	2	2
37	Electrode, Main Burner	03.6506.34	1	1	1	1	1
38	Knob, Main Burner	03.6506.35	1	1	1	1	1
39	Valve/Hose/Regulator, Main burner	03.6506.36	1	1	1	1	1
40	Level Vial	03.6506.37	1	1	1	1	1
41	Side Table Accessory	03.6506.38	All	All	All	All	All
42	Grid, Side Burner	1210.5.001	----	1	----	1	1
43	Side Burner/Table Accessory (Replacement)	1220.5.001	All	All	All	All	All
44	Cover, Side Burner/Table	03.6506.39	----	1	----	1	1
45	Knob, Side Burner	03.6506.40	----	1	----	1	1
46	Screw, M3.5x8mm Torx (Side Burner Valve)	03.6506.41	----	2	----	2	2
47	Valve Assembly, Side Burner	03.6506.42	----	1	----	1	1
48	Pin, Cotter 1.6mmx28mm (Side Burner Valve)	03.6235.00	----	2	----	2	2
49	Electrode, Side Burner	03.6506.43	----	1	----	1	1
50	Burner, Side	03.6506.44	----	1	----	1	1
51	Lantern Gas Tube	03.6506.45	----	----	1	1	1
52	Lantern	03.6506.46	----	----	1	1	1
53	Cover, Lantern Top	03.6506.47	----	----	1	1	1
54	Globe, Lantern	03.6506.48	----	----	1	1	1
55	Mantle, Lantern	03.6506.49	----	----	2	2	2
56	Screw, #10x3/4" Type 25 Csk (Lantern Knob)	03.6506.50	----	----	1	1	1
57	Knob, Lantern	03.6506.51	----	----	1	1	1
58	Screw, #4-24x3/8" Type 25 (Lantern Housing)	03.6506.53	----	----	2	2	2
59	Electrode/Piezo, Lantern	03.6506.54	----	----	1	1	1
60	Pushbutton, Lantern	03.6506.55	----	----	1	1	1
61	Lantern/Gas Tube Accessory	1230.5.001	All	All	All	All	All
62	Carry Bag Accessory	1240.5.001	All	All	All	All	All

SETTING UP YOUR GRILL

CAUTION

- To reduce the risk of a cut or pinching injury:
- Wear protective gloves when handling parts that have sharp edges.
 - When opening legs, keep hands and fingers away from the three body leg mount areas to avoid pinching. (See FIG. 2A)

STANDING GRILL ON LEGS

STEP 1) With your grill flat on the floor, release the Hood latch from the Hood Handle. (**FIG. 1**) Open Hood and remove any accessories from the grid that are with your model. Do not remove anything else at this step. Close and re-latch the hood.

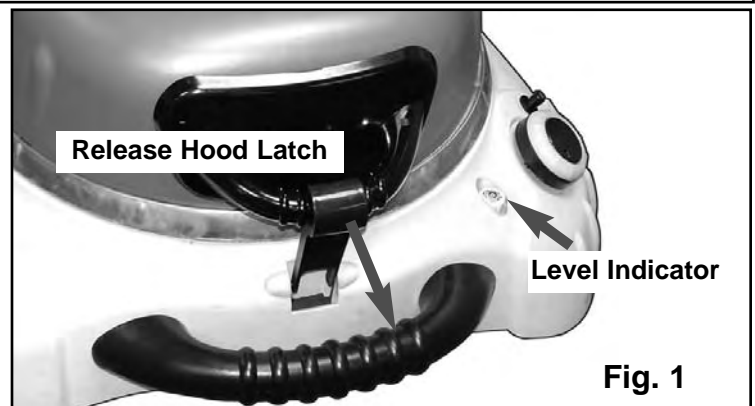
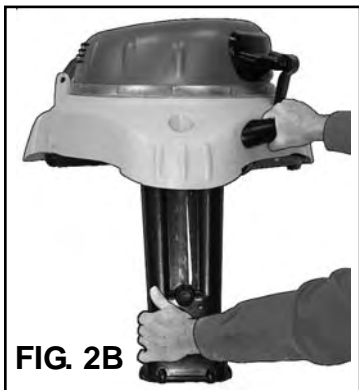
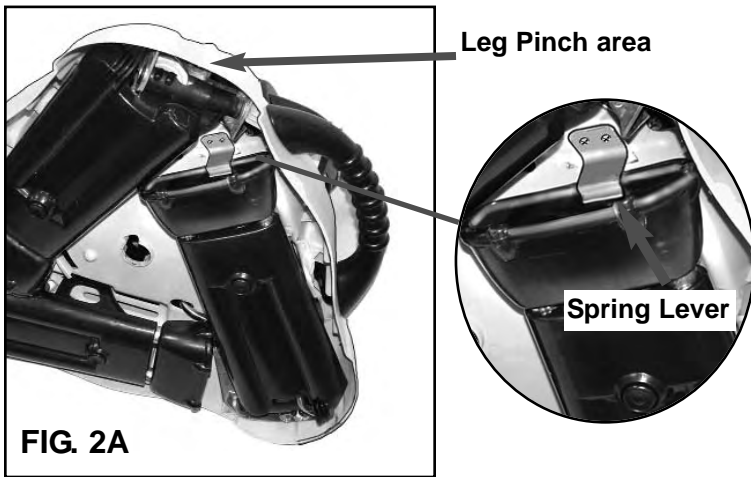
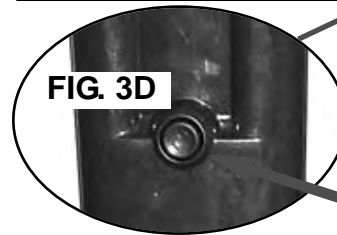
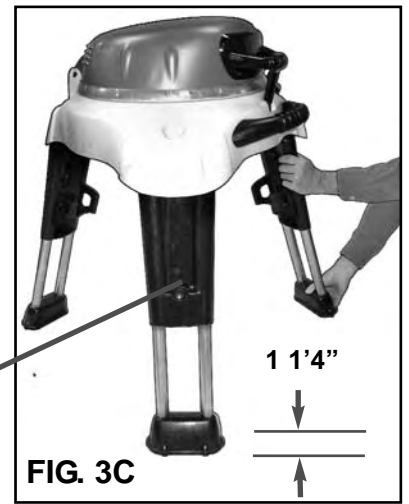

Fig. 1

STEP 2) Lift grill up at one leg mount. Release the spring lever at each leg foot. **(FIG. 2A)** Swing each leg all the way out one at a time, and let it rest on the floor. **(FIG. 2B, 2C & 2D)** The last leg will allow the grill to stand by itself. This is the lower height for use.



STEP 3) To use the grill at the full height, slide the legs out one at a time until they stop. You do not have to use the leg adjustment for full leg extension. **(FIG. 3A, 3B & 3C)**



STEP 4) If the grill is not standing level, the legs can be adjusted to level it. There are 3 adjustments within a range of 1 1/4" from the fully extended leg in which to level the grill.

While supporting the grill, depress the round leg button with your thumb on the leg or legs that need to be adjusted. **(FIG. 3C & 3D)** Slide the leg in or out until you find the setting that best allows leveling. You will hear a light click at each setting when extending the leg. Check the grill level by the level indicator located to the left of the Main Grill control knob. **(See FIG. 1 page 5)**

STEP 5) Unlatch the hood and remove the Grid. Disconnect the Electrode wire underneath the bowl. **(FIG. 4A)** At a point directly opposite the control knob, lift up the Bowl Pan and burner and remove from the grill. **(FIG. 4B)** Remove the styrofoam pads inside the bowl area and any that fall toward the middle. Remove any other accessories that may be packed inside. Reinstall the Bowl Pan. Insert the burner tube and electrode wire through the hole in body. The burner guide should engage the burner tube over the valve nozzle. Check visually to make sure it does engage. Reconnect the electrode wire. Replace the Cooking Grid. **(See page 16)**

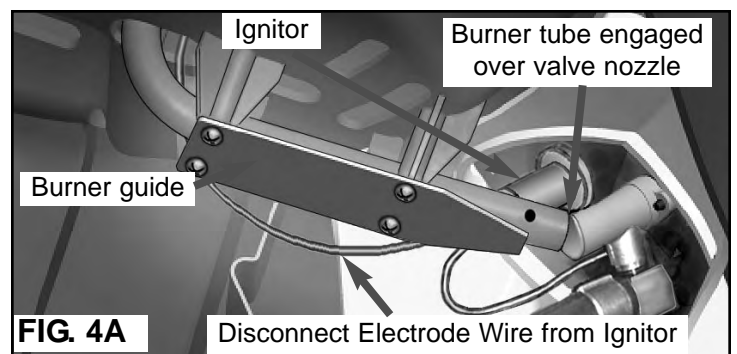

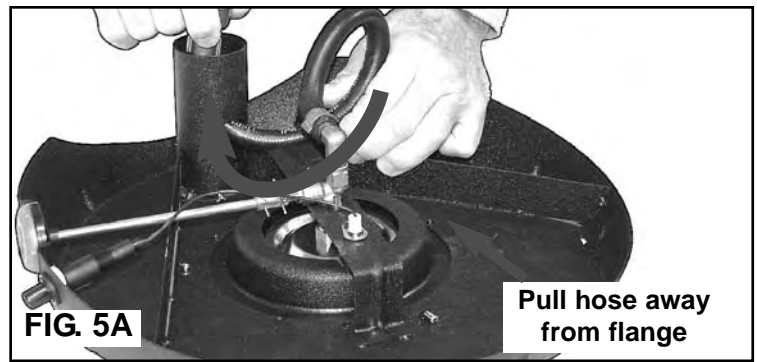

⚠ WARNING

- To reduce the risk of serious bodily injury or death:
- Do not load plastic side table or side burner with more than 10 lb./4.5kg (one gallon liquid/3.8L). Excess weight could tip grill over causing a fire or explosion and damage side table or side burner.
 - Do not place hot utensils or cookware on plastic side table or side burner cover that can cause them to melt.

SIDE TABLE ASSEMBLY

Insert the tubular collar into the left leg PTO™ (Propane Take-Off™) opening of the grill until the Side Table rests snugly against the grill body. **(FIG. 4A & 4B)** Rotate the Side Table back and forth slightly to make sure it is resting solidly. Do not apply excessive force.



SIDE BURNER ASSEMBLY

STEP 1) Turn Side Burner Table upside down. **(FIG. 5A)** Pull the hose away from the side burner table flange. Pull threaded coupling end out of collar while feeding the hose through hole in the side of the collar. Pull the hose until the loop is taken out and hose is extended out of the collar. **(FIG. 5B)**



STEP 2) Turn the Side Burner Table right side up and insert the hose end through the left leg PTO™ opening of the grill. **(FIG. 5C)** Push the Side Burner Table down until the collar rests on the internal stop. **(FIG. 5D)** Rotate the Side Burner Table back and forth slightly to make sure it is resting solidly. Do not apply excessive force.



STEP 3) Hook Side Burner Grid into far left hole in side table and lower two wires into the other two holes. **(FIG. 5E)**

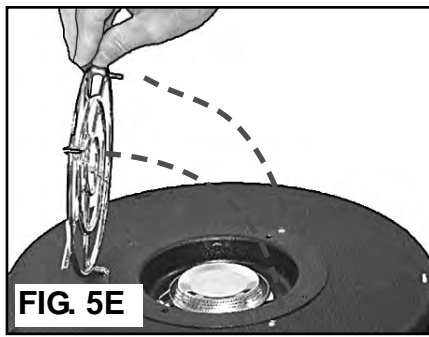

STEP 4) Your Side Burner can be used as a Side Table when not using the Side Burner. Locate the 3-hooks of the polyethylene Side Burner Cover over the 3-slots on the side burner edge. **(FIG. 5F)** Push the 3-hooks into the slots. Lock cover by rotating clockwise with the two finger hole notches opposite each other on the cover. The finger hole notches are also used for unlocking and removing the cover.



Insert the large opening of the Mantle over the burner. **(FIG. 6B)** NOTE: The colored end should be at the top. Pull the mantle down over the burner until the large opening encircles the two bottom burner notches and the top opening encircles the two top burner notches. **(FIG. 6C)** Form the mantle to a conical shape around the burner. **(FIG. 6D)** **NOTE: Do not tear a hole in the mantle.** If you do, use another one. Always have spare mantles handy. (See Warnings page 15.)

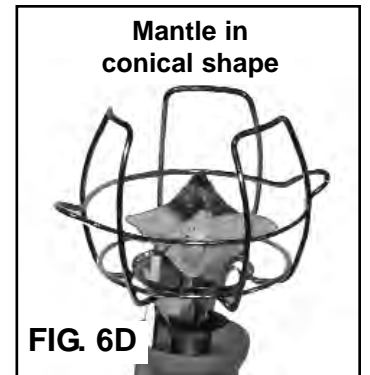
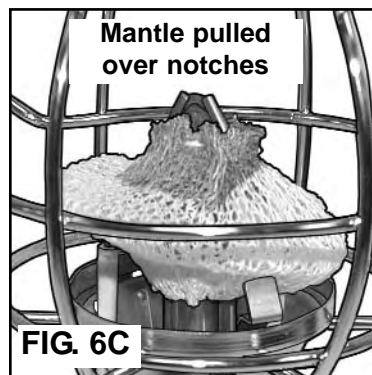
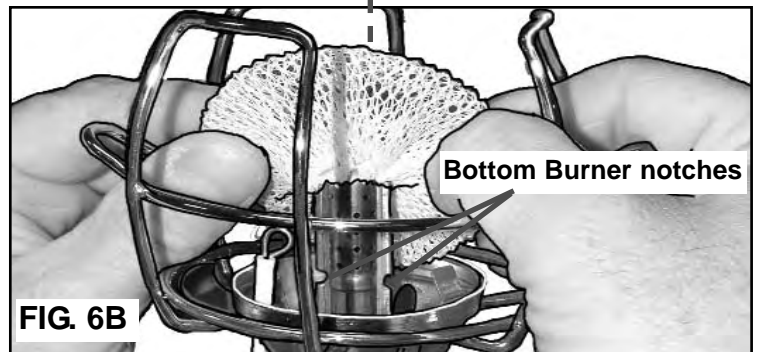
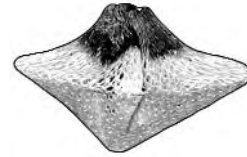

! WARNING
 Use Lantern only with a 1 pound LP cylinder. Do not attempt to connect to any other size cylinders.
LANTERN ASSEMBLY

STEP 1) Assemble Mantle to Lantern: Place Lantern on a table. (You may sit down for this step.) Lift the Lantern top cover off and remove the glass globe. **(FIG. 6A)** Assemble mantle over the top and bottom burner notches.

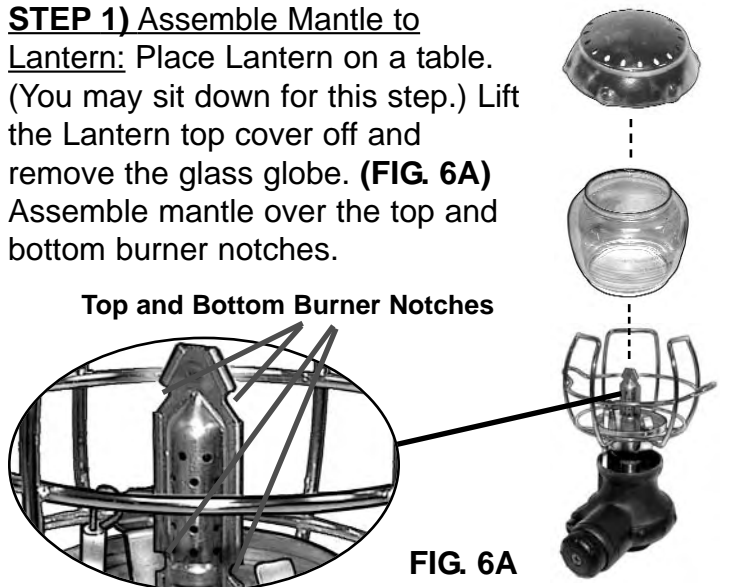

STEP 2) Pre-burn Mantle: Use a match to light the mantle the first time. **(Note: Mantle will burn without gas.)** **(FIG. 6E)** Let the mantle burn until it shrinks to a bulb shape and turns white. **(FIG. 6F)** Allow the Lantern to cool; then replace the globe and top cover. Do not touch the mantle or it will be destroyed.



STEP 3) Assemble Lantern and Gas Tube: Insert the gas tube into the lantern nozzle. **(FIG. 7A)** Engage the knurled coupling into the lantern and turn until snug. **(FIG. 7B)** Be careful not to cross thread the connection.

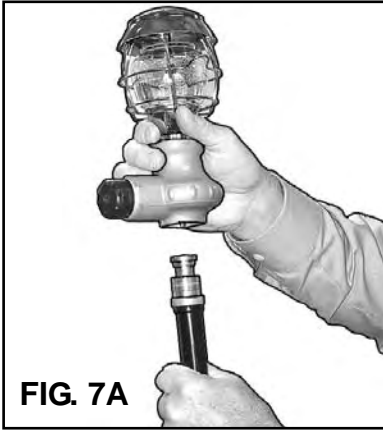

STEP 4) Assemble Lantern & Tube to Grill: Remove the gas tube clip from under the leg by loosening the two screws securing it. (This is for store display grills and not needed for your use.) Just re-tighten the screws into the leg. **(FIG. 7C)**

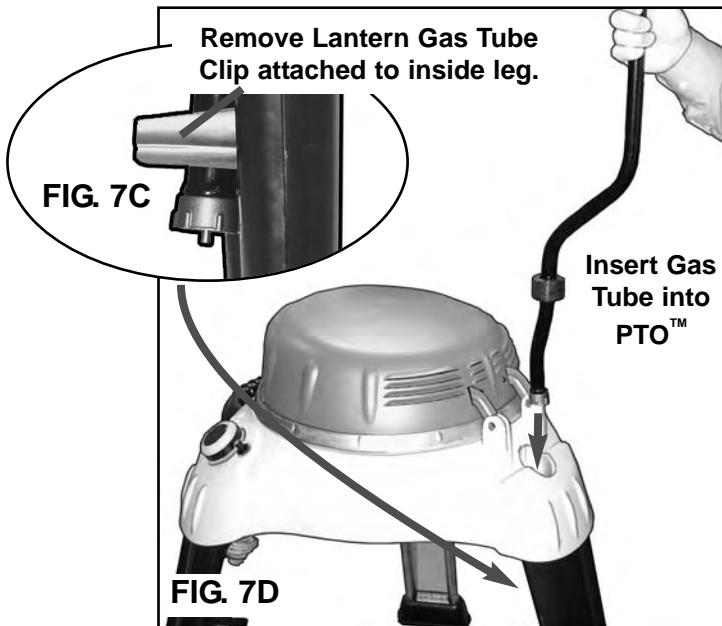

Insert the crooked end of the Lantern gas tube into the rear leg PTO™ opening. **(FIG. 7D)** **Note: In order for the Lantern gas tube to be upright, it must be secured to the LP cylinder and the cylinder must be secured in the leg holder. You may delay gas tube installation until instructed on pages 10 & 11 or proceed there now to secure the gas tube.**

Rotate the Lantern head around the gas tube to the desired position for access and use. Make sure gas tube is turned properly to allow hood to open.

! WARNING

- To reduce the risk of serious bodily injury or death:
- Always burn portable lantern on a flat level surface in an upright position away from any flammable substances.
 - When carrying Portable Lantern, hold it away from you and do not run with it.
 - Do not use gas tube with Lantern and 1 pound LP cylinder when using Lantern as a portable light. It is not stable and will cause lantern to fall over.
 - To prevent being knocked over, always disconnect lantern and LP cylinder before storing.
 - Do not allow children to use the portable lantern. Keep bystanders, children and pets away from the lantern.

STEP 5) Portable Use of Lantern:

Lantern can be connected to a 1 lb. cylinder for use as a portable light. **(FIG. 7G)** Hold the Lantern with one hand. Insert the LP cylinder into the Lantern nozzle with other hand. Turn LP cylinder until snug. Follow leak test procedure on page 12 before using.



INSTALL GREASE CONTAINER

! WARNING

- To reduce the risk of serious bodily injury or death:
- Never light the LP gas grill without the Grease Container in place.

From underneath the grill, align the tab and Grease Container opening with that in the bottom of the Bowl. **(FIG. 8A)** Push the Grease Container in and rotate the V-shape end until it locks into position under the bracket in the Bowl bottom. **(Fig. 8B)**

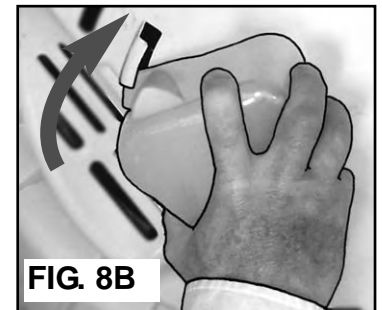
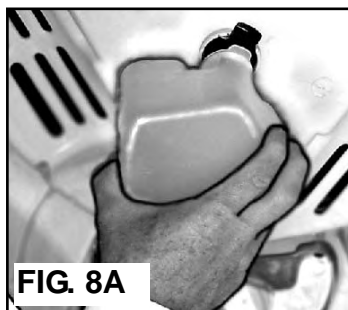

Connecting/Disconnecting LP Gas Cylinders

INSTALLATION CODES

WARNING

- To reduce the risk of serious bodily injury or death:
- This installation must conform with local codes or, in the absence of local codes, with either the National Fuel Gas Code, ANSI Z223.1, or CAN/CGA-B149.2, Propane Installation Code.
 - If an external electrical source is utilized, the outdoor cooking appliance, when installed, must be electrically grounded in accordance with local codes or, in the absence of local codes, with the National Electrical Codes, ANSI/NFPA 70, or the Canadian Electrical Code.

LP CYLINDER

WARNING

- To reduce the risk of serious bodily injury or death:
- Use only 1 pound LP cylinders with this grill and the appliances.
 - Read and follow all warnings on LP gas cylinder.
 - If you see, smell, or hear the hiss of LP gas escaping from the cylinder:
 1. Do not attempt to light appliance.
 2. Extinguish any open flame.
 3. Disconnect from fuel supply.
 - Do not operate the LP gas grill without the LP gas cylinder attached or secured to the grill as shown in Assembly Instructions.
 - Maintain cylinder in upright position to provide for proper fuel withdrawal.
 - Do not use an LP gas cylinder if it shows signs of dents, gouges, bulges, fire damage, corrosion, leakage, excessive rust or other forms of visual external damage; it could be hazardous and should be checked by a liquid propane supplier.
 - Never connect or disconnect LP cylinder or fittings near open flame or while grill or accessories are burning.
 - When the LP gas cylinder is connected, keep the grill outside in a well-ventilated space.
 - Turn off all control knobs to grill, side burner and lantern when grill is not in use.
 - Do not attempt to refill or repair a 1 pound disposable LP cylinder. It could cause a hazard or explosion.

1 pound Disposable LP Cylinders, for use with Aussie LP gas grills, must meet the following requirements:

- 1) Only use cylinders marked "Propane Fuel"
- 2) 1 pound Cylinder size should be 4" diameter x 8" tall.
- 3) Cylinder must be constructed and marked in accordance with the U.S. Department of Transportation (DOT) or the National Standard of Canada, CAN/CSA-339. (See LP cylinder marking)
- 4) Cylinder must have a cylinder cap to protect LP cylinder valve when not in use.

HOSES AND REGULATOR

WARNING

- To reduce the risk of serious bodily injury or death:
- Use only the hose and regulator assembly that have been supplied with this gas grill. Do not use hose and regulator from another manufacturer.
 - Always check for gas leaks when you connect and disconnect the LP gas cylinder.
 - Make sure there are no sharp bends in the hose.
 - Make sure gas hoses do not contact hot surfaces.
 - Clean and inspect the gas hose/regulator before each use. Replace the hose/regulator before using grill if there is evidence of abrasion, wear, cuts or leaks.
- If the hose and regulator assembly is not working properly and you need a replacement, contact the manufacturer (1-800-251-7558). Be sure to specify your grill model.

WARNING

- To reduce the risk of serious bodily injury or death:
- Always inspect LP cylinder connections for damage or debris before connecting cylinders.
 - Always connect or disconnect propane cylinders out doors away from flame, ignition sources and only when the appliance is cool to the touch.

STEP 1) Turn control knobs of Main grill, Side Burner and Lantern to the "Off" position. (FIG. 9A, 9B & 9C)

Main Grill
Control Knob 'Off'

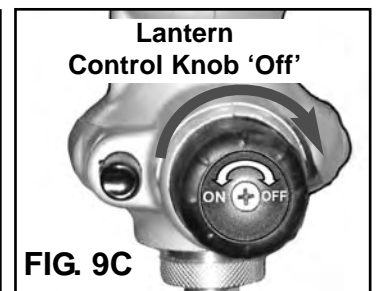
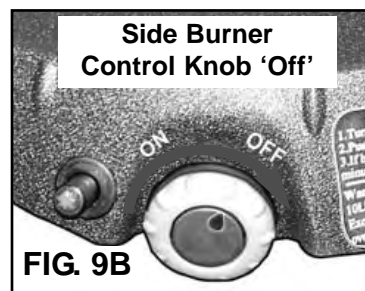
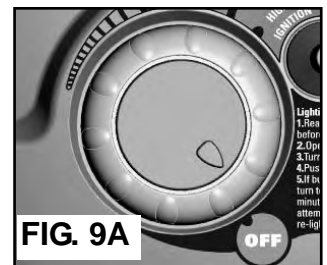

STEP 2) Connecting a 1 pound disposable cylinder to Lantern, Main grill Burner and Side Burner is very similar. First remove protective cap from Cylinder nozzle. (FIG. 10A)

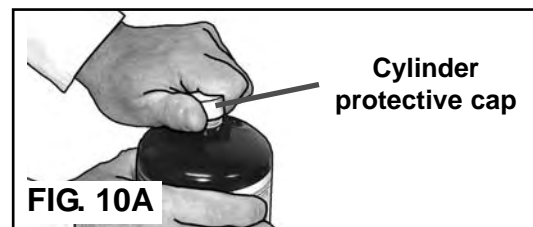

STEP 3) Connect 1 pound Cylinder to Grill and Accessories: Grasp the regulator to the grill (**FIG. 10B**), Side burner hose coupling (**FIG. 10C**), or Lantern gas supply tube (**FIG. 10D**) with one hand. Hold Cylinder upright with other hand. Push cylinder nozzle into the threaded connection and turn cylinder by hand until snug. Do not turn Cylinder upside down. Do not use tools. Make sure the connection does not cross thread. Swing Cylinders into Leg Holders and snap into place. (**FIG. 10E**)

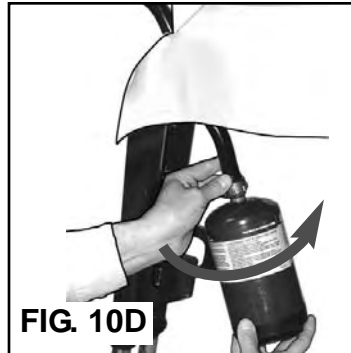

⚠ WARNING

· To avoid gas in your face and eyes, do not hold an LP cylinder connection toward you when disconnecting.

STEP 4) Disconnecting 1 LP Cylinder: Turn control knobs of Main grill, Side Burner and Lantern to the “Off” position. Unscrew 1 lb. LP cylinders from the threaded connections until they are released. Store the cylinders in a safe place. (See previous LP Cylinder Warnings.)

OPERATING AND MAINTAINING YOUR GAS GRILL

BEFORE USING YOUR LP GAS GRILL

USING GAS

⚠ DANGER

CARBON MONOXIDE HAZARD

- This appliance can produce carbon monoxide which has no odor. Using it in an enclosed space can kill you.
- Never use this appliance indoors, on recreational vehicles, or boats.

⚠ WARNING

To reduce the risk of serious bodily injury or death:

- Use only 1 pound propane cylinders in this grill.
- LP gas is not natural gas. Do not attempt to convert an LP unit to natural gas or a natural gas unit to LP gas. Any unspecified use or alteration of this unit could be unsafe and will void your warranty.
- Always use a gas appliance outdoors in an open area with good ventilation to avoid breathing toxic fumes from leaking gas, explosion or fire. In addition, the combustion products of such fuels, including liquified petroleum (LP), contain chemicals known to the state of California and other authorities to cause cancer, birth defects and other reproductive harm.

SELECTING A LOCATION

⚠ WARNING

To reduce the risk of serious bodily injury or death:

- Keep grill and accessory appliances clear and free from combustible materials, gasoline and other flammable vapors and liquids.
- Locate your LP gas grill in an open area with good ventilation and at least 10 feet away from your house or building. Do not use the grill in a garage, breezeway, carport, porch, high traffic area or under any surface that can catch fire.
- Minimum clearance from sides and back of grill to adjacent combustible construction should be 36 inches from sides and 36 inches from back. Minimum horizontal clearance from sides and back of grill to adjacent combustible construction extending above top of unit should be 40 inches.
- Locate your LP gas grill on a level stable surface in an area clear of combustible material. If surface is not level, grill must be leveled by adjusting the legs. An asphalt surface (blacktop) may not be acceptable for this purpose.
- Do not use an LP gas grill indoors, on recreational vehicles, or boats.
- Do not use gas grill as a space heater.
- Make sure legs are fully open before using the grill.

Before using your gas grill perform a leak test on the Control Valves, Regulator/Hose connections and fittings. (following page)

PERFORMING A LEAK TEST

WARNING

To reduce the risk of serious bodily injury or death:

- Always perform a leak test before each use.
- Never use a match or open flame to test for gas leaks.
- Perform a leak test in a well ventilated area.
- Do not perform a leak test on a grill while it is hot or in use.
- Do not use the LP gas grill if you detect a gas leak that cannot be corrected by using the leak test procedures on following page.

How to perform a leak test:

Supplies Needed for a Leak Test: Clean paint brush, water, and dish washing liquid.

- 1) Use a 1 pound disposable LP Cylinder.
- 2) Make sure the control knobs to grill and accessories are turned to the “off” position.
- 4) Mix one part of water with one part of dish washing liquid.
- 5) Connect LP cylinders to the main grill burner, the side table burner and the lantern.
- 6) Check for leaks by brushing the soap solution on all LP gas connections and fittings indicated by the heavy arrows in **(FIG. 12A-2D)** Make sure you generously brush the locations with the soap solution, completely surrounding the connections and fittings.
- 7) If “growing” bubbles appear on any of the connection points, you have detected a gas leak. Immediately disconnect the LP cylinder.
 - A) If leak appears at either end of hose and regulator assembly, retighten the connection at the leak, but do not over tighten. (Note: Only hand tighten cylinder connections.) Repeat Leak Test.
 - B) If the leak is coming from the LP gas cylinder itself, from the valves at the control knobs, or if the leak cannot be stopped, do not use the grill. Call Customer Service at 1-800-251-7558.
- 8) Upon completion of leak test:
 - A) Turn all control knobs to the “Off” position.
 - B) Disconnect LP cylinders from the connections to the Main Grill Burner, Side Burner and Lantern.
- 9) Place the protective cap over the LP cylinder gas nozzles. Store the cylinders in a safe place.

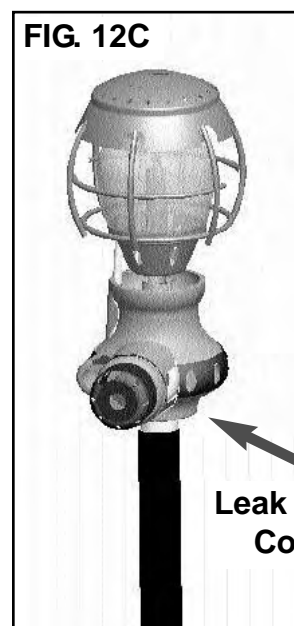
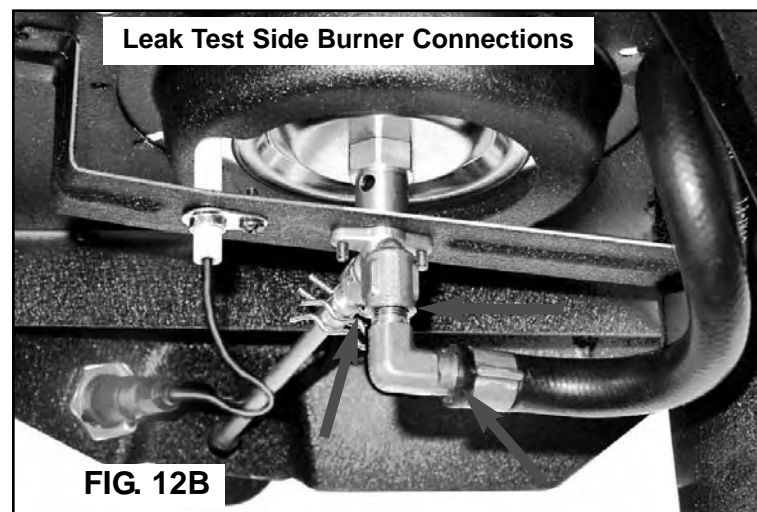
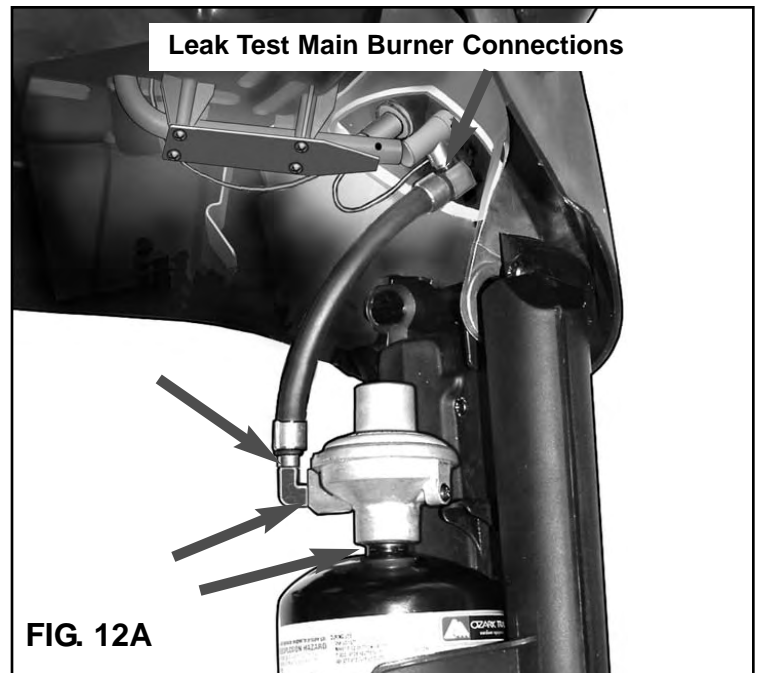

Leak Test Lantern Connections

When used on the grill.

When used as portable lantern.

LIGHTING THE GAS GRILL

⚠ WARNING

To reduce the risk of serious bodily injury or death:

- Use only 1 pound LP cylinder with this Grill.
- Open Hood before lighting the grill to prevent an explosion from gas build-up.
- Make sure there are no obstructions to the flow of combustion and ventilation air to the main grill.
- During failed lighting attempts, or if the side burner goes out during the cooking process, turn control knob “Off” to dissipate any accumulation of gas. Wait five minutes before repeating lighting procedure.
- To avoid burns, keep hands and fingers away from the burner ring when manually lighting with a match.

IGNITION LIGHTING MAIN GRILL

1. Open the Hood. Make sure LP cylinders are installed.
2. Important: Make sure main grill control knob is turned “Off” first.
3. Push the control knob in and turn to the “High” position. (FIG. 13A)
4. Push the Ignitor button in several times to light the burner. Listen for the spark ignition and look to make sure the burner is lit. If no spark, see (FIG. 13B) and [Troubleshooting Section](#).
5. If Grill burner fails to light, repeat Steps 3-4.

If the burner fails to light after three or four attempts following Steps 3-5, turn control knob to the “Off” position. Wait five minutes; then repeat the lighting procedure. NOTE: If the burner still fails to light, refer to the [Troubleshooting Section](#). The burner can also be lit manually, see [Manual Lighting Grill](#).

6. After ignition, turn the control knob to “High” for 3-8 minutes and close the Hood to preheat the grill. Preheat the grill before every cooking session.)

If the burner goes out during operation, turn the control knob to the “Off” position. Open hood and wait five minutes before attempting to relight the grill. If it does not relight, turn control knob to the “Off” position. Make sure there are no open flames nearby, then disconnect the cylinder and see if it is empty.

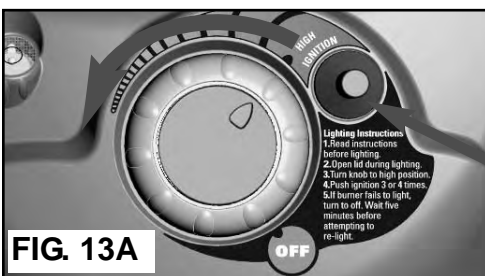

Push in Control Knob and turn to “High”.

Ignitor Button

MANUAL LIGHTING MAIN GRILL

1. Open the Hood. Lift the Cooking Grid off the Grill.
2. Important: Make sure main grill control knob is turned “Off” first.
3. Hold a lit match near the burner ring. (FIG. 13C)
4. Push the control knob in and turn to the “High” position. (FIG. 13A)
5. If Grill burner fails to light, repeat Steps 3-4.

If the burner fails to light after three or four attempts following Steps 3-5, turn control knob to the the “Off” position. Wait five minutes; then repeat the lighting procedure. NOTE: If the burner still fails to light, refer to the [Troubleshooting Section](#).

6. After ignition, replace the Cooking Grid. Turn the control knob to “High” for 3-8 minutes and close the Hood to preheat the grill. Preheat the grill before every cooking session.)

If the burner goes out during operation, turn the control knob to the “Off” position. Open hood and wait five minutes before attempting to relight the grill. If it does not relight, turn control knob to the “Off” position. Make sure there are no open flames nearby, then disconnect the cylinder and see if it is empty.

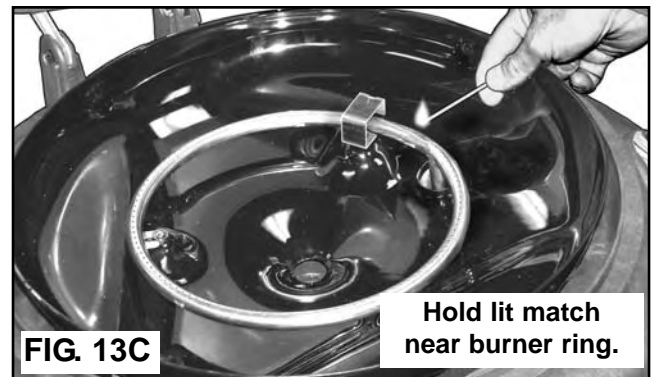

FIG. 13C

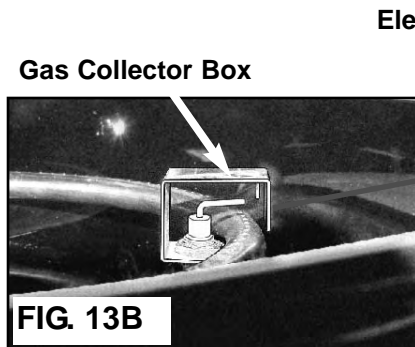
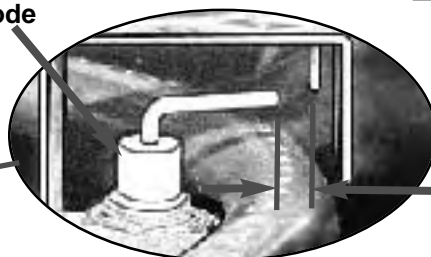

FIG. 13B

Electrode



3/16" Gap from Tab to Electrode

⚠ WARNING

To reduce the risk of serious bodily injury or death:

- Use only 1 pound LP cylinder with Side Burner.
- Remove plastic Side burner cover before lighting the Side burner to prevent an explosion from gas build-up or melting of the cover.
- Make sure there are no obstructions to the flow of combustion and ventilation air to the side burner.
- During failed lighting attempts, or if the side burner goes out during the cooking process, turn control knob “Off” to dissipate any accumulation of gas. Wait five minutes before repeating lighting procedure.
- To avoid burns, keep hands and fingers away from the burner ring when manually lighting with a match.

IGNITION LIGHTING THE SIDE BURNER

1. Remove Side Burner Cover if on.
2. Important: Make sure Side Burner Control Knob is turned “Off” first.
3. Turn Side Burner Control Knob on by rotating counter clockwise. (FIG. 14A)
4. Push the Ignitor button in several times to light the burner. Listen for the spark ignition and look to make sure the burner is lit. If no spark, see (FIG. 14B) and [Troubleshooting Section](#).
5. If Side Burner fails to light, repeat Steps 3 and 4.

If Side burner fails to light after three or four attempts following Steps 3-4, turn control knob off by rotating control knob clockwise until it stops. Wait five minutes; then repeat the lighting procedure. NOTE: If the burner still fails to light, refer to the [Troubleshooting Section](#). The burner can also be lit manually, see [Manual Lighting Side Burner](#).

6. After ignition, turn the control knob to the desired setting for use.

If the side burner goes out during operation, turn the control knob to the “Off” position. Wait five minutes before attempting to relight the grill. If it does not relight, turn control knob to the “Off” position. Make sure there are no open flames nearby, then disconnect the cylinder and see if it is empty.

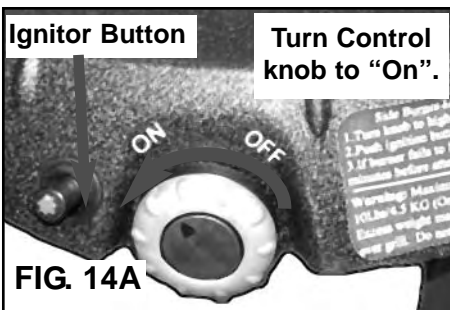

MANUAL LIGHTING THE SIDE BURNER

1. Remove Side Burner Cover if on.
2. Important: Make sure Side Burner Control Knob is turned “Off” first.
3. Hold a lit match near the burner. (FIG. 14C)
4. Turn Side Burner Control Knob to the “On” position. (FIG. 14A)
5. If Side Burner fails to light, repeat Steps 3 and 4.

If Side burner fails to light after three or four attempts following Steps 3-4, turn control knob off by rotating control knob clockwise until it stops. Wait five minutes; then repeat the lighting procedure. NOTE: If the burner still fails to light, refer to the [Troubleshooting Section](#).

6. After ignition, turn the control knob to the desired setting for use.

If the side burner goes out during operation, turn the control knob to the “Off” position. Wait five minutes before attempting to relight the grill. If it does not relight, turn control knob to the “Off” position. Make sure there are no open flames nearby, then disconnect the cylinder and see if it is empty.

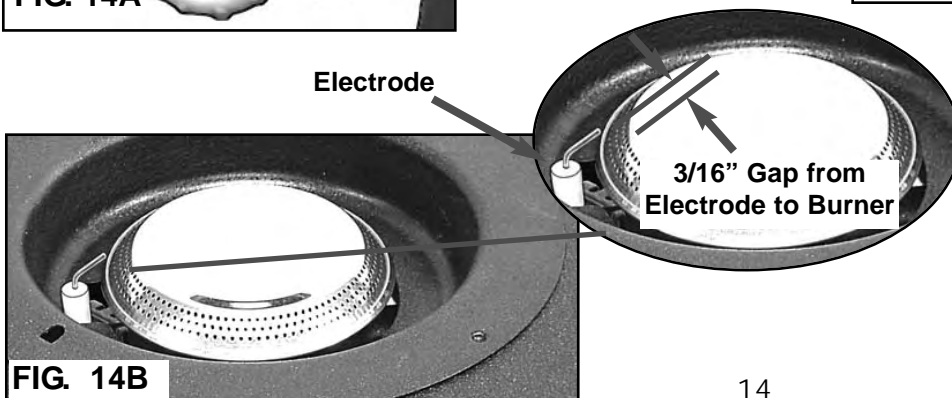
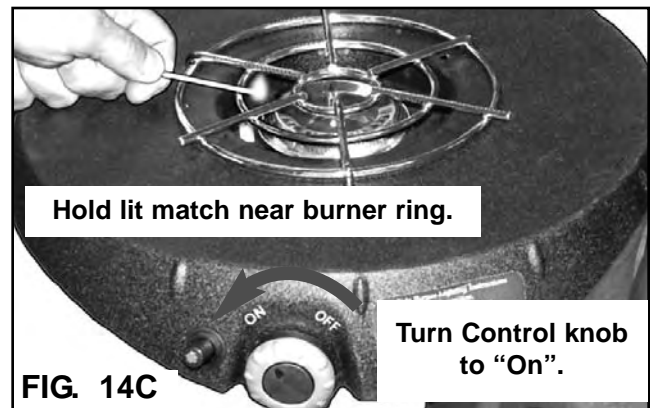

⚠ WARNING

To reduce the risk of serious bodily injury or death:

- Use only 1 pound LP cylinder with Lantern.
 - Do not use gas tube with Portable Lantern and 1 pound LP cylinder. It is unstable and will cause lantern to tip over and cause a fire.
 - Make sure there are no obstructions to the flow of combustion and ventilation air to the Lantern.
 - Always burn lantern in upright position away from any flammable substances.
 - Use lantern for lighting only. Do not touch hot surfaces.
 - Hold the lantern by the cylinder when transporting. Hold it away from you and do not run with it.
- Always light and use lantern outdoors. Never use indoors, on recreational vehicles, or boats.
 - To avoid eye damage, do not stare into the intense light.
 - Never operate lantern with a hole in the mantle or overheating and fire hazard could result.
 - Never operate lantern without a globe shield or top cap.
 - To avoid burns, do not place your head or body over the lantern when manually lighting with a match.
 - When lighting attempts fail, or if the Lantern goes out during use, turn control knob “Off” to dissipate any accumulation of gas. Wait five minutes before repeating lighting procedure.

IGNITION LIGHTING THE LANTERN

1. Check to make sure lantern parts are intact and not disrupted and cylinder is properly connected.
2. Important: Make sure Lantern Control Knob is turned “Off” first.
3. Turn the Control Knob to the ‘On’ position until it stops. (FIG. 15A)
4. Push the Ignitor button in several times to light. Listen for the spark ignition and look to make sure the burner is lit. If no spark, refer to the [Troubleshooting Section](#).
5. If Lantern fails to light, repeat Steps 3 and 4.

If Lantern fails to light after three or four attempts following Steps 3-4, turn control knob to the “Off” position. Wait five minutes; then repeat the lighting procedure. Note: If the burner still fails to light, refer to the [Troubleshooting Section](#). The burner can also be lit manually, see [Manual Lighting Lantern](#).

6. After ignition, turn the control knob to adjust the amount of light that is desired.

If the lantern burner goes out during operation, turn control knob to the “Off” position. Wait five minutes before attempting to relight the grill. If it does not relight, turn control knob to the “Off” position. Make sure there are no open flames in the grill, side burner or nearby; then disconnect the cylinder and see if it is empty.



MANUAL LIGHTING THE LANTERN

1. Important: Make sure Lantern control knob is turned “Off” first.
2. Hold a lit match through one of the base openings below the burner. (FIG. 15B)
3. Turn the Control Knob to the ‘On’ position until it stops. (FIG. 15A)

4. If Lantern Burner fails to light, repeat Steps 2 and 3.

If burner fails to light after three or four attempts following Steps 2-3, turn control knob to the the “Off” position. Wait five minutes; then repeat the lighting procedure. NOTE: If the burner still fails to light, refer to the [Troubleshooting Section](#).

5. After ignition, turn the control knob to the desired setting for use.

If the Lantern goes out during operation, turn the control knob to the “Off” position. Wait five minutes before attempting to relight the grill. If it does not relight, turn control knob to the “Off” position. Make sure there are no open flames in the grill, side burner or nearby; then disconnect the cylinder and see if it is empty.

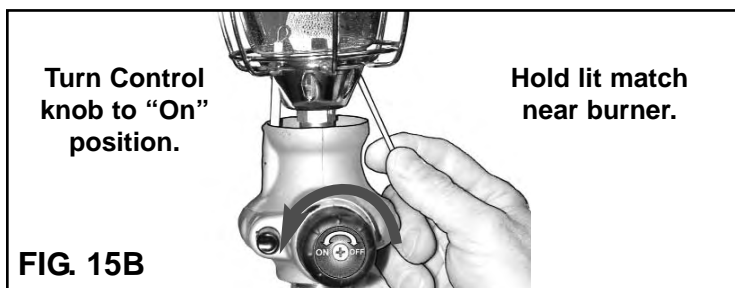

CHECK YOUR FLAME

Your burners have been preset by the manufacturer for optimal flame performance. A blue flame, possibly with a small yellow tip, is the result of the optimal air and LP gas mixture for the main burner and side burner. (FIG. 16) The lantern should glow white.

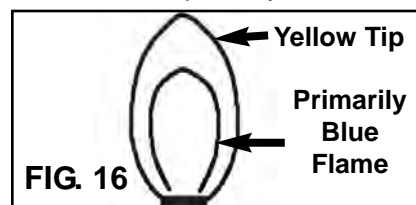

Check the flame before each cooking session and throughout the grilling season. Always check especially after long periods of storing the grill. If the flame is significantly yellow in color, the appropriate amount of LP gas in the air/LP gas mixture is not correct. This could be due to a blocked burner from grease drippings or from insects building a nest inside the burner or burner opening. See [How to Clean the Burners](#).

OPERATING THE LP GAS GRILL

! WARNING

To reduce the risk of serious bodily injury or death:

- Never use charcoal in your LP gas grill. Do not use aerosols or store flammable liquids or materials near this gas grill.
- Keep regulator hose away from any heated surfaces.
- Check the LP gas grill for gas leaks and Burner obstructions before each use.
- To prevent an explosion from gas build-up, always open the hood before lighting the LP gas grill.
- Do not attempt to extinguish a grease fire with water or other liquids. Have a BC fire extinguisher nearby. Do not douse or spray the grill or cooking grid with water when hot. Burns from splattered grease or the water could occur.
- If your LP gas grill catches on fire:
 - If the fire is in the grill portion and you can safely reach the control knob, then turn it to the off position.
 - If the fire involves one of the hoses, and you can safely reach the LP cylinder, disconnect the cylinder.
 - If the fire involves the cylinder, leave it alone, evacuate the area and call the fire department.
 - If there is any type of fire that threatens either personal safety or endangers property, call the fire department.
- Do not use the grill without Grease Container in place. Check the Grease Container for grease buildup. Empty excess grease to avoid a grease fire in the pan.
- If you notice grease or other hot material dripping from the grill onto the valve, hose, or regulator, turn off the control knob immediately. After the grill has cooled, determine the cause and correct it. After cleaning the valve and hose and regulator assembly, perform a leak test before continuing use. (See Performing a Leak Test.)
- Do not operate an LP gas grill if you have knowledge of or suspect a gas leak.
- Do not wear loose clothing (example: hanging shirt tails, clothing with frills, etc.) around a LP gas grill while in use or hot.
- Do not lean your body over the LP gas grill when lighting it or while it is in use or hot.
- Do not touch hot surfaces. Use heat resistant gloves, long-handled tongs, or cooking mitts at all times since the grill will become very hot. Open the hood carefully when cooking to avoid the hot air and steam trapped inside.
- Do not allow children to operate or play near an LP gas grill. Keep animals and bystanders out of the grill area. Do not leave grill unattended.
- Do not move an LP gas grill when in use or hot. Do not drag or put side pressure on the legs.
- Do not allow cords of any electric appliance or rotisserie near heated surfaces of the LP gas grill; place electric cords away from walkways to avoid a tripping hazard.

- Always disconnect LP gas cylinder when not in use. Allow grill to cool before handling parts or cleaning.
- Remove grill covers and store at least 36 inches from the LP gas grill while in use. Grill covers are made of a flammable material. Allow the grill to completely cool before putting the cover back on the grill.

GRILL COOKING

! WARNING

- Always make sure the Grease Container is empty and is properly installed in the Bowl before each cooking.
- Do not leave any utensils on a hot Cooking Grid or cookware. Do not place hot utensils on the plastic side burner cover or table, they will melt.

1) Make sure the Cooking Grid is clean. (See Care and Maintenance.) Place Cooking Grid on the bowl and rotate the raised lip that is halfway around the grid to the rear of the grill. **(FIG. 17A)** The Cooking Grid will seat only one way when the two long ribs under the grid fall into the two notches in the bowl at the 3 and 6 o'clock positions. **(FIG. 17B)**

2) Preheat the Grill with the hood closed, on "High" for about 3-8 minutes. Do not pre-heat over 8 minutes or the Cooking Grid coating may be destroyed. During the first use, there may be a slight odor from the curing oil on paint or parts.

3) After preheating, carefully place food on the Cooking Grid. Cook until done, turning food at least once halfway through the cooking time for most foods. Adjust flame as needed with the Control Knob.

4) When food is cooked, remove food with long-handled heat resistant, plastic or wooden utensils so as not to scratch the non-stick surface. Never use metal tongs, forks or knives as these can damage the coating on the Cooking Grid.

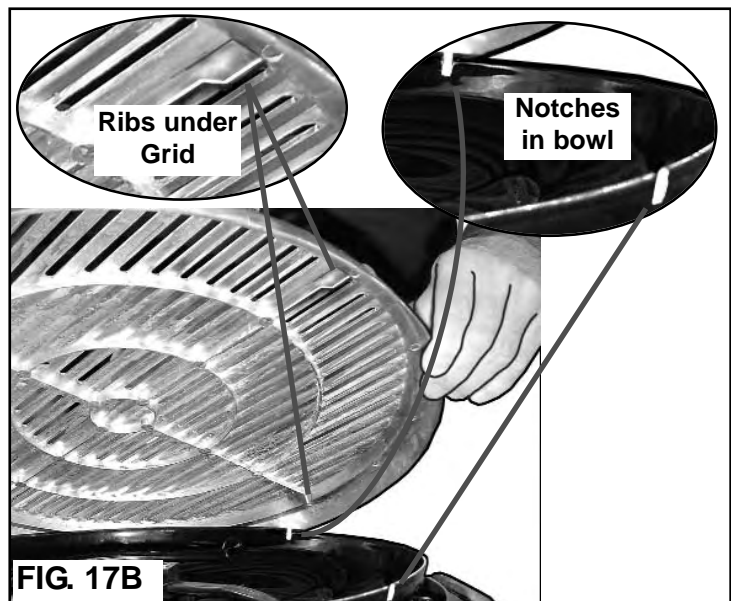
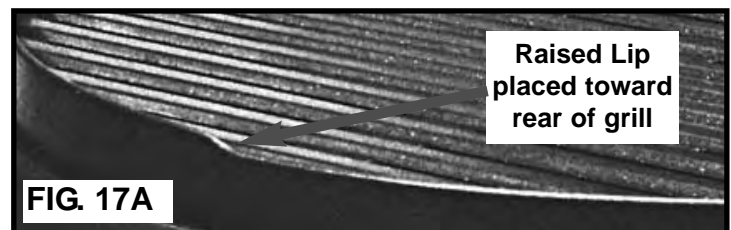

END OF COOKING SESSION

WARNING

- To avoid burns, allow the grill and the grease in the grease container to cool before emptying, handling parts or cleaning.
- To reduce the risk of a fire, empty the Grease container after each cooking session so excessive grease does not accumulate.
- Never light the LP gas grill without the Grease Container in place.
- Allow grill to completely cool before replacing side burner cover.

- 1) When you have finished using your grill, turn the grill Control Knob clockwise to the "Off" position. Make sure there are no open flames nearby,
- 2) Disconnect the LP cylinder from the Grill Burner, Side table Burner and the Lantern. Remove the Lantern and gas tube from the grill. Store them in a safe place.
- 3) Wait until the grill is cool before closing the hood, cleaning or putting on a cover.
- 4) Regularly clean your LP gas grill between uses and after extended storage periods. To maintain the condition and extend the life of your grill, cover the unit when stored outside for any length of time, especially during the winter months.

CARE AND MAINTENANCE

CAUTION

To reduce the risk of a cut injury:

- Be careful or wear protective gloves when cleaning grill parts that have sharp edges.

CLEANING THE GRILL

- 1) Remove Grease Container and Cooking Grid.
- 2) **Grease Container**-Wash the Grease Container with soap and water.
- 3) **Cooking Grid**-Clean the residue off with a baking soda and water solution. For stubborn stains, use a non-abrasive scouring powder. Do not use steel wool or other abrasive cleaners that can scratch the non-stick coating. This can cause foods to stick.
- 4) **Hood and Body**-It is not necessary to remove all the grease from inside the hood. Wipe the outside hood and body with paper towels or soft damp cloth. For further cleaning, use warm soapy water and a cloth. Do not use steel wool, oven cleaner or other abrasive cleaners that can scratch the painted surfaces.
- 5) Remove excess grease and/or fat from the Bowl with a soft plastic or wooden scraper or nylon-bristled brush only. Do not immerse the gas controls. Avoid getting water in the Burner Holes. The Bowl Pan can be removed for additional cleaning or replacement. Follow procedure for removing the burner screw and Main Grill Burner. Then disconnect the electrode wire from the Ignitor under the grill and lift the Bowl Pan out. **(Fig. 18A & 18B)**

To re-install the Bowl Pan, be sure to locate the indents on the (4) Bowl Pan posts and re-connect the electrode wire.

- 5) **Lantern**-Wipe clean the lantern housing, globe and top cap with a mild detergent and soft cloth. Do not use abrasive cleaners that will scratch the housing.
- 6) **Burners**-Clean the Burners annually, or whenever heavy build-up is found, to ensure that there are no signs of blockage (debris, insects) in either the burner portholes, the primary air inlet, or the neck of the burner. (See Burner cleaning instructions next section.)

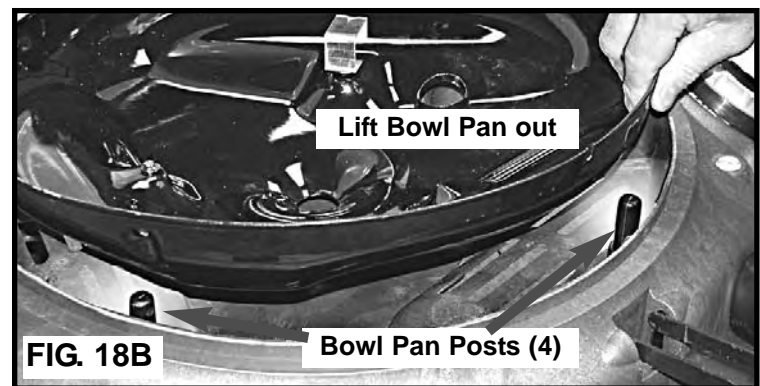
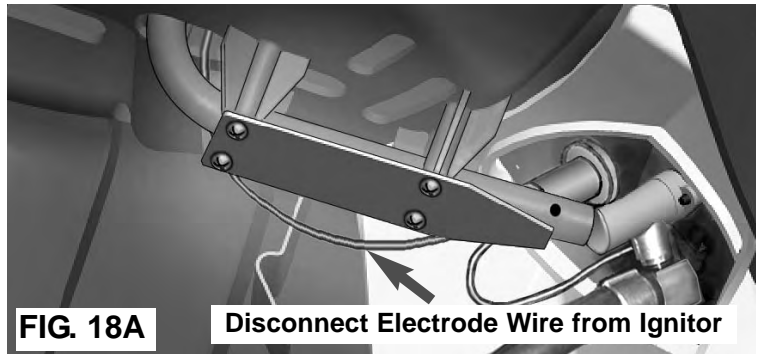

WARNING

To reduce the risk of fire beneath the grill:

- Inspect and clean clogged burner/venturi tubes for insects and insect nests.
- Make sure LP cylinders are disconnected from the grill Main Burner, Side Burner and Lantern, that all control knobs are turned off, and the grill is completely cooled before cleaning the burners.

How to Clean the Burners:

- A) Main Grill Burner and Side Burner:
 - a) Remove the Cooking Grid.
 - b) Remove the Main Grill Burner, by first removing the single screw securing it to the bowl. **(FIG. 18C)**
 - c) Remove Burner from the grill by lifting the burner up and out. You do not have to remove Side Burner.
 - d) Use a pipe cleaner to clear insect nests from the Main Burner and the Side Burner inlet hole. **(FIG. 18D & 18E)** Open up clogged burner holes with a small nail or wire. **(FIG. 18D & 18F)** Normal wear and corrosion could enlarge some holes, however, if large cracks or holes are found, replace the Burner. **Note: It is normal for surface rust to be present on the burners.** The burners can be wire brushed and coated with cooking oil periodically. Make sure there are no insects or insect nests blocking the inlet hole.

f) If grill is to be stored, coat Burner lightly with cooking oil and wrap in a protective cover to keep insects out.

B) Lantern Burner:

a) Remove the top cover and glass globe. Open up clogged burner holes with a small nail or wire. (FIG. 19A) Normal wear and corrosion could enlarge some holes, however, if large cracks or holes are found, replace the Burner. **Note: It is normal for surface rust to be present on the burners.**

b) Remove the two screws from the housing. (FIG. 19B) Hold the knob and lift the housing off. Check the burner inlet holes. Use a pipe cleaner to clear insect nests from the Burner inlet hole. (FIG. 19C) Replace the housing and two screws.

6) After cleaning, re-install Main Grill Burner. Replace Grease Container and Cooking Grid. Note: When refitting the Burner, be sure it is positioned correctly. The valve should protrude inside the venturi end of the burner. (FIG. 18G) Re-tighten the Main Burner screw. (FIG. 18C)

7) Check burner operation after re-assembly.

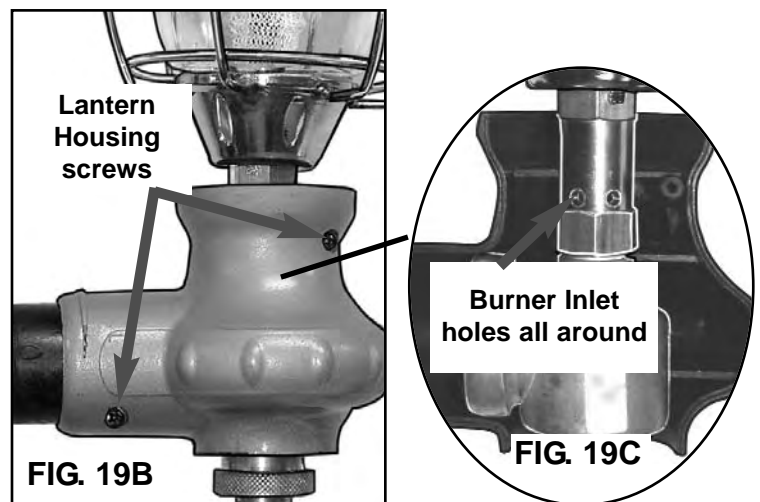
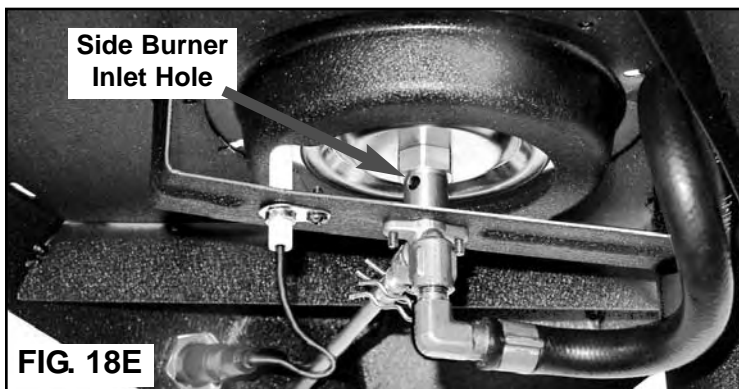
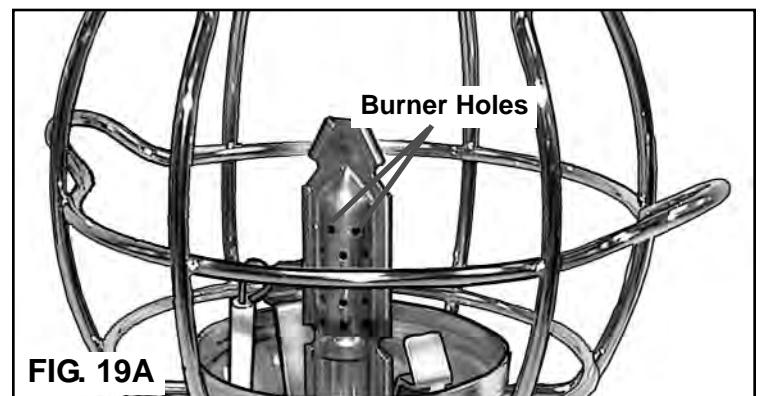
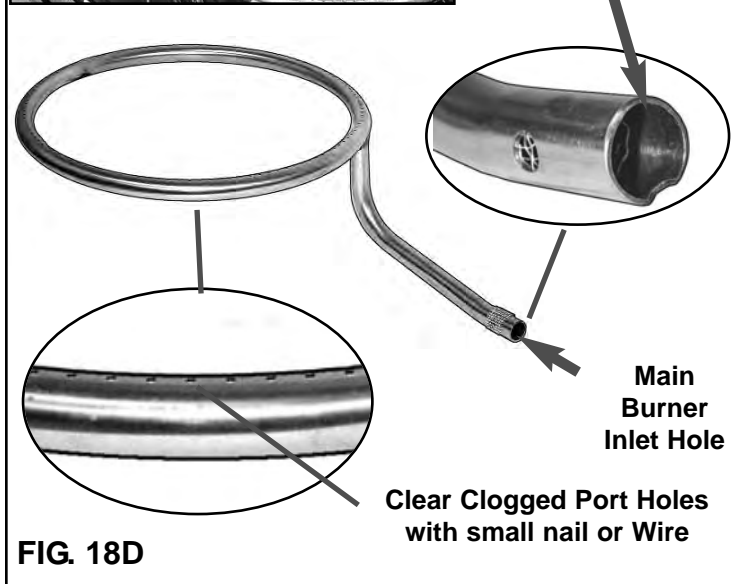
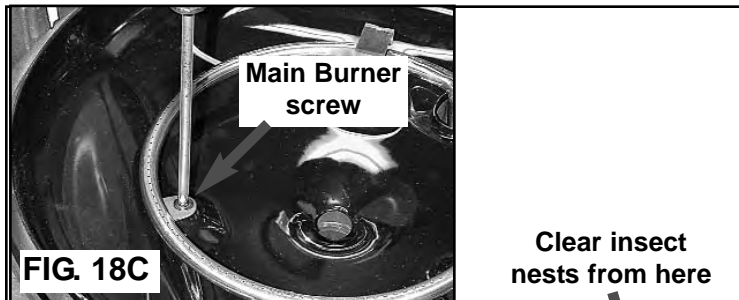
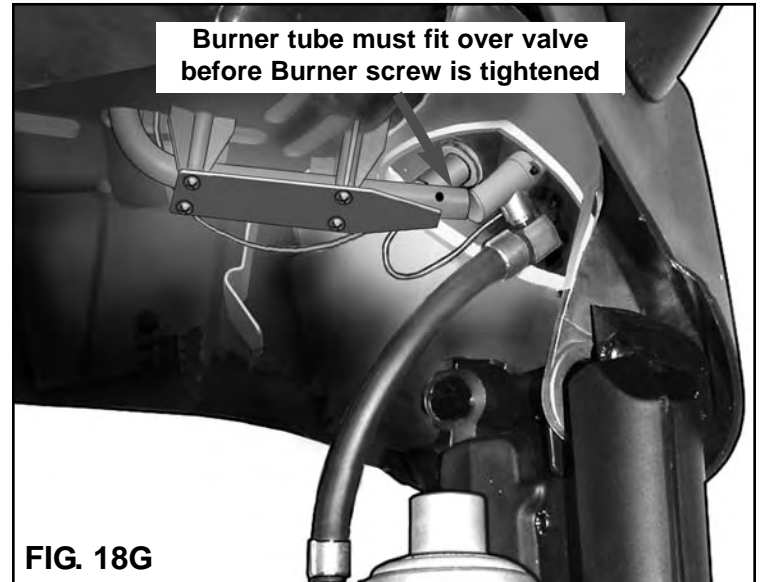
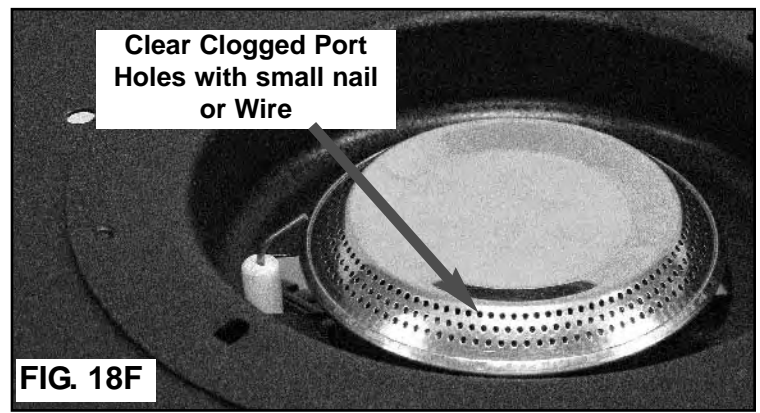

STORAGE AND TRANSPORT

WARNING

To reduce the risk of serious bodily injury or death:

- Disconnect all LP gas cylinders when not in use and before storage. Gas will vent from lantern gas tube and side burner. Make sure you disconnect cylinders away from you to avoid gas fumes and odor in your face.
- Store your LP gas grill in a cool, dry place. You can store your grill indoors only if the cylinders are disconnected.
- Do not store an LP cylinder indoors (empty or filled). Make sure there are no open flames nearby, then disconnect the LP cylinders from the gas grill. Store LP cylinders outdoors out of the reach of children.
- To avoid an explosion, do not leave an LP cylinder inside a vehicle that can become overheated by the sun. Do not store an LP cylinder in any space greater than 125 degrees Fahrenheit.
- Even though an LP cylinder may appear to be empty, gas may still be present and the cylinder should be transported and stored safely.
- To avoid an explosion from a gas leak, do not store a spare LP gas cylinder under or near the LP gas grill.

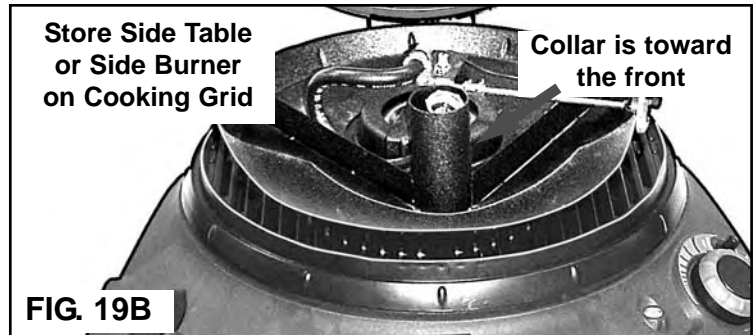
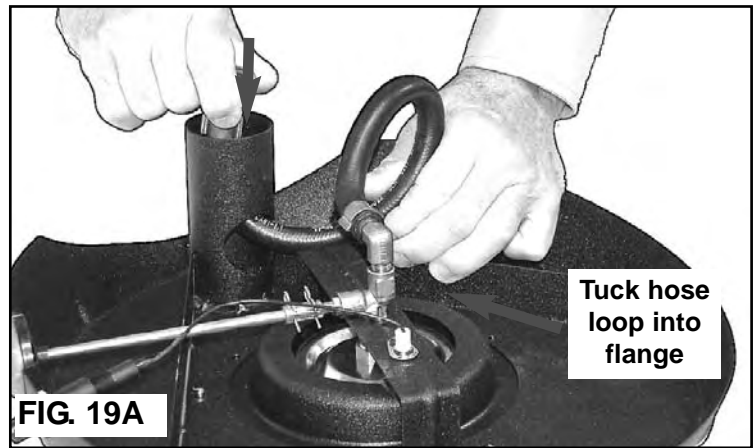

- 1) Disconnect LP gas cylinders from Main Grill, Side Burner and Lantern. Re-cap LP cylinders with the Safety Caps. If storing the LP cylinders in folded legs for transport, leave the 1pound disposable cylinders in the leg cylinder holders. **(See Step 3, page 9)** Note: Hold the cylinder stationary against the bottom base in the holder pocket until leg is fully closed and snaps into the spring lever. The legs will not fully close if this is not done properly. Otherwise, store LP Gas cylinders outside in a dry, well-ventilated area, away from any sources of heat or ignition.
- 2) Disconnect Lantern from the gas supply tube. Remove Gas Supply Tube from the PTO™ opening in grill body and store separately from grill in a safe and convenient place.
- 3) If storing the gas grill outdoors in the set-up position, remove lantern and gas tube then simply place a grill cover over the grill. The grill may be stored indoors only if the LP cylinders are disconnected from the gas grill and stored outdoors. Store the gas tube and lantern in a safe place.
- 4) If storing grill for transport in the grill cover:
 - a) Install the Side Burner Cover on the Side Burner Table. Remove the Side Burner Table or the Side Table. Turn the Side Burner upside down. Push the hose back down into the collar while pulling with the other hand. **(FIG. 19A)** Tuck the hose within the flange.
 - b) Place Side Burner (or Side Table) upside down on the Cooking Grid under the Hood. **(FIG. 19B)** Make sure the collar is toward the front so the hood will close.
 - c) Close and latch the Hood. Secure the 1 pound. LP gas cylinders in the leg holders and fold the legs under the grill. **(FIG. 19C)**
 - d) For temporary storage or transport, just pick up the grill and carry it to another destination. **(FIG. 19D)**

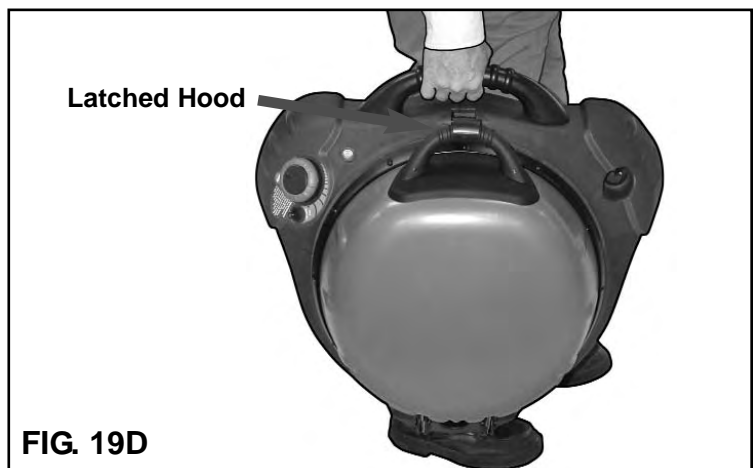
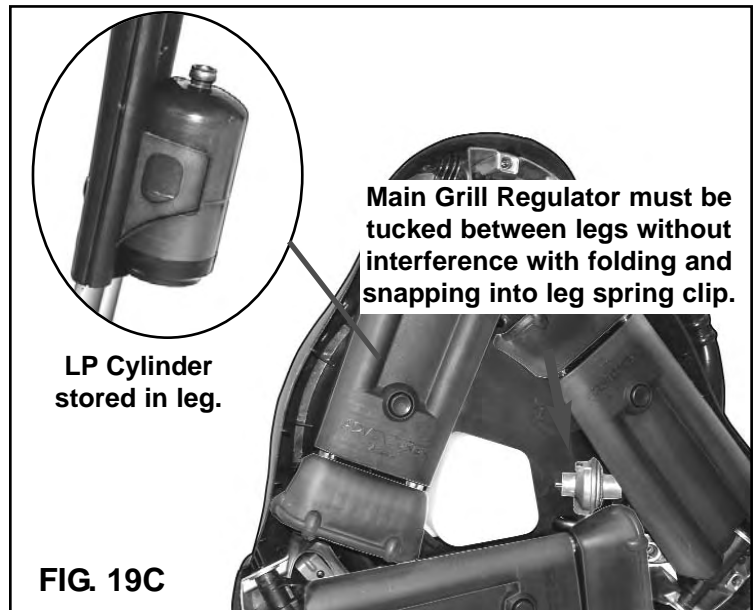

- e) Unzip the Grill Cover and lay it out flat as shown. **(FIG. 19E)** With grill legs folded under the grill, place the grill on the grill cover.
- f) Unzip the pocket in the grill cover and place Lantern inside as shown. **(FIG. 19F)** Zip the Lantern pocket.
- g) Carefully fold over the grill cover flap, allowing the Lantern to rest on top of the body above the left leg. Zip the grill cover and allow the handle to protrude through the opening of the grill cover. The grill can be transported and stored in a compact manner. **(FIG. 19G)**
- 5) Before using the grill, after periods of storage or non-use (i.e. over winter), check your LP gas grill for gas leaks, deterioration, proper assembly, and burner obstructions.
- 6) Periodically check and tighten all nuts, bolts, and screws. Make sure all electrode and ground wires are not loose.

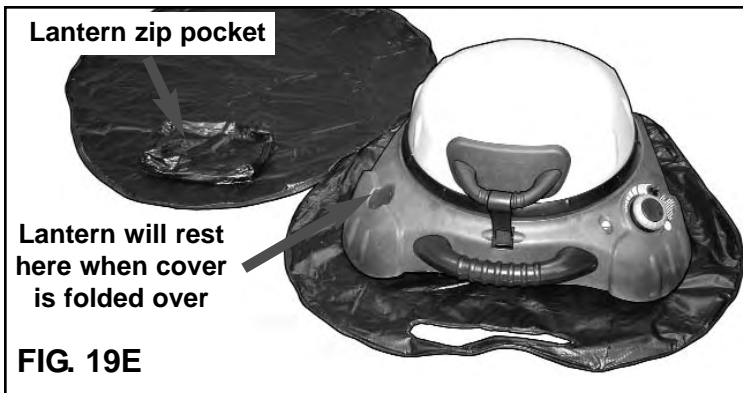

TROUBLESHOOTING

<u>Problem:</u>	<u>Possible Cause:</u>	<u>Solution:</u>
Burner will not light using the Ignitor	Burner is not connected to Valve.	Make sure burner tube is over the gas nozzle. See How to Clean the Burners #6 page 17 : Re-install after cleaning.
	Not pausing long enough before clicking the Ignitor	When lighting the Burner, push-in and turn control panel knob counter-clockwise to the high position. Pause 4 seconds, then Push in Ignitor button several times so that it clicks each time.
	No spark	Gas collector tab is bent (making too large or small of a gap between electrode and tab). By hand, bend gas collector tab to approximately 3/16" gap to electrode. (See page 13 & 14 for illustrations). NOTE: Be very careful adjusting Side Burner electrode gap. The Ceramic can break.
	LP gas cylinder is empty	Make sure gas Collector, Ignitor and electrodes are tight. Make sure electrode wires and ground wire are connected to Ignitor. Replace 1 pound disposable cylinder.
	1 lb. Cylinder Coupling Nut not fully connected	Tighten 1 pound Cylinder or coupling nut by hand. Do not use tools.
LP Excess flow valve tripped in regulator	Turn control knob to "Off" position. Wait five minutes. Relight LP gas grill. If flame remains to be low, turn off gas at the grill. Disconnect the regulator from the LP gas cylinder. Reconnect the regulator to the LP gas cylinder. Perform a leak test; rlight grill. This will reset the excess flow valve.	

TROUBLESHOOTING (Cont'd)

Problem:	Possible Cause:	Solution:
Grill Burner will not light using a match	Obstructions in burner	See How to Clean the Burners page 17- Re-install after cleaning
	Electrode and burner are wet	Dry electrode with clean cloth. Air dry or use blow dryer.
	Electrode wire and/or ground wire loose or disconnected	Reconnect the electrode and ground wires.
	Wire is shorting (sparking between Ignitor wire and electrode)	Replace Ignitor wire/electrode assembly (Call the Customer Service Department)
	Burner not connected to valve.	Make sure burner tube is over the gas nozzle. See How to Clean the Burners page 17- Re-install after cleaning.
	LP gas cylinder is empty	Replace 1 pound disposable cylinder.
	LP Excess flow valve tripped in regulator	Turn control knobs to "off" position and turn LP gas cylinder handle clockwise until it stops. Wait five minutes; relight LP gas grill.
1 lb. Cylinder Coupling Nut not fully connected to regulator	Tighten coupling nut by hand about one-half to three quarters additional turn. Do not use tools.	
Low flame or low heat	Obstructions in burner	See How to Clean the Burners page 17- Re-install after cleaning
	Gas in LP Cylinder is low	Replace 1 pound disposable cylinder.
	Excess flow valve tripped in regulator	Turn control knob to "Off" position. Wait five minutes; relight LP gas grill. If flame continues to be low, turn off gas at cylinder and grill. Disconnect the regulator from the LP gas cylinder. Reconnect the regulator to the LP gas cylinder. Perform a leak test. Relight grill. This will reset the excess flow valve.
Flames blow out	High or gusting winds	Turn grill in a different direction or increase flame height..
	Gas in LP Cylinder is low	Replace 1 pound disposable cylinder.
	Excess flow valve tripped	See "Low flame" problem above.
Flare up	Grease build up	Clean the grill.
	Excessive fat in meat	Trim fat from meat before grilling.
Persistent grease fire	Grease trapped around burner system	Turn control knob "Off". Open hood carefully and let fire burn out. After the grill cools, remove and clean all parts. Check and clean Grease Cup.
Humming or whistling from the regulator	Outside temperature, humidity, barometric pressure, and the gas level within cylinder may cause rubber diaphragm inside the regulator to vibrate, with a humming or whistling sound.	Although this sound may be alarming, this is NOT dangerous as long as it is not accompanied by the smell of gas. Simply adjust the burner settings and usually the sound will subside. If the humming sound persists, a change in atmospheric conditions will eventually stop the vibration. Should you smell gas, do not use the grill and call Customer Service at 1-800-251-7558

If your problem is not resolved from the information above, please call Customer Service at 1-800-251-7558.

MECO CORPORATION
LIMITED WARRANTY

This product is warranted to the original consumer purchaser against defects in material and workmanship under normal outdoor household use and correct assembly (if assembled by the consumer-purchaser). Burner and Cooking Grid are warranted for a period of one (1) year from the date of purchase. All other parts are warranted for a period of one (1) year from the date of purchase. Mecco Corporation DOES NOT warrant in any way the propane cylinder (see label on cylinder for cylinder manufacturer's warranty.) The LP cylinder manufacturer is responsible for the materials, workmanship and performance of the cylinder. If the cylinder has a defect, malfunctions, or you have a question regarding the cylinder, call the cylinder manufacturer's customer service center. The phone number is on the cylinder. If the cylinder manufacturer has not resolved the issue to your satisfaction, then call Mecco Corporation at the customer service number listed below.

Mecco Corporation requires proof of purchase and we suggest you keep your receipt. Damages caused by commercial or institutional use, accidental or intentional damage, repairs made or attempted by unauthorized persons, or misuse are not covered by this warranty. If defective, the part or product will be repaired or replaced at the option of Mecco Corporation without charge.

This warranty does not include the cost of any inconvenience or property damage due to failure of the product and does not cover damage due to misuse, abuse, accident, damage arising out of transportation of the product, damage incurred through commercial use, or failure to perform normal and routine maintenance. LIABILITY FOR CONSEQUENTIAL PROPERTY OR COMMERCIAL DAMAGES ARE EXPRESSLY EXCLUDED BY THIS WARRANTY. ANY APPLICABLE IMPLIED WARRANTIES OF MERCHANTABILITY AND FITNESS ARE LIMITED IN DURATION TO THE PERIOD COVERAGE OF THIS EXPRESS WRITTEN LIMITED WARRANTY. Some states do not allow limitation on how long an implied warranty lasts, so this limitation may not apply to you.

Deterioration or damage due to severe weather conditions such as hail, hurricanes, earthquakes or tornados, discoloration due to exposure to chemicals either directly or in the atmosphere, is not covered by this limited warranty.

No returns will be accepted without prior authorization from Mecco Corporation. Authorization for return may be obtained by calling 1-800-251-7558. Handling and transportation costs for returning the product are not covered by this warranty and will be paid for by the purchaser. Please send your correspondence to:

MECO CORPORATION
Attn: Customer Service
1500 Industrial Road
Greeneville, TN 37745

For reference and correspondence,
record your Serial number here.
(See nameplate on side of grill.)

Serial No. _____
Please use this number in registering
your warranty and any correspondence
with Mecco Corporation.

Leg Lock Assembly Instructions for Open/Close Leg (Note: Use these instructions with Step 2 on page 6.)

⚠ CAUTION

To reduce the risk of a cut or pinching injury:

- Wear protective gloves when handling parts that have sharp edges.
- When opening legs, keep hands and fingers away from the three body leg mount areas to avoid pinching.

OPENING LEGS-As you open the legs in Step 2 on page 6, notice the new leg lock assembly that will automatically lock in the open position as each leg is opened. (FIG.1)

CLOSING LEGS-Raise the Spring lever outward with your thumb and begin closing leg underneath the grill. Release the lever as the rod slides back within the tube. (FIG. 2)

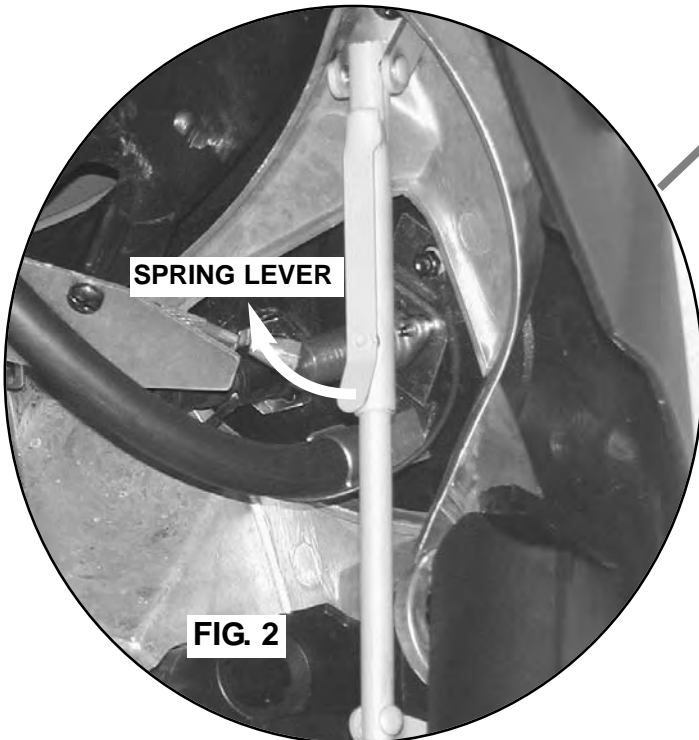
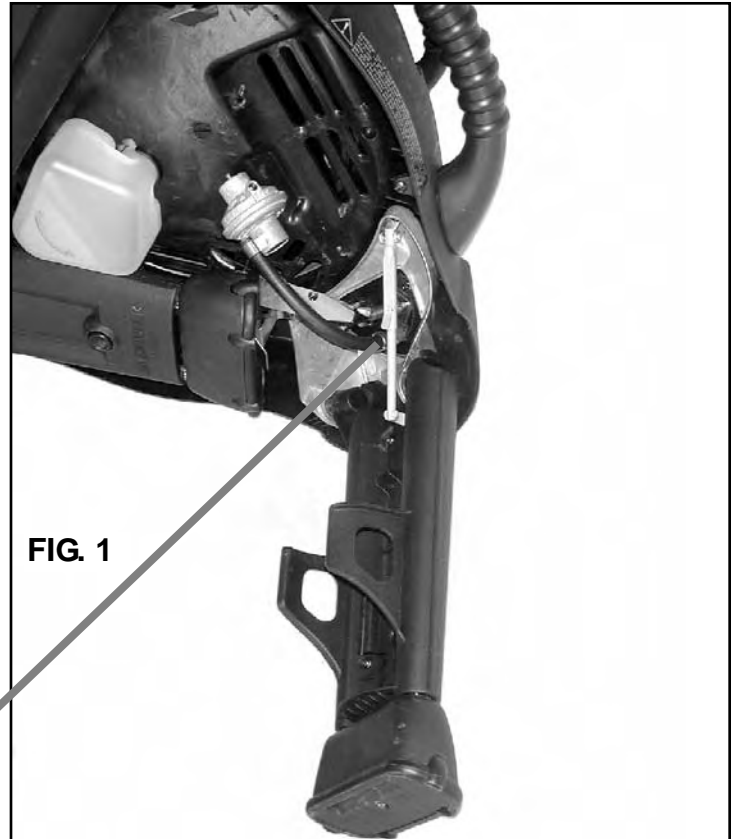

SPRING LEVER

FIG. 2

STEP 2. Loosen the 2-screws holding the plastic Gas Tube Clip in the rear leg. Pull it away and discard it. (FIG. 3) (This is for store display grills and not needed for your use. Disregard mention of plastic clip at Step 4 on page 9.) Re-tighten the 2-screws.

Continue at Step 3, page six of Owner's Manual.

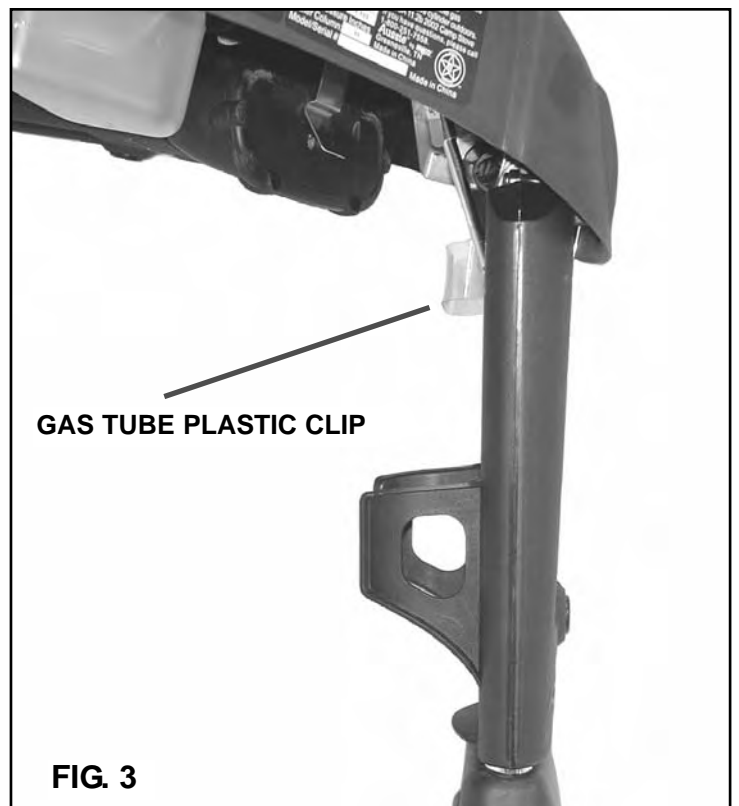

GAS TUBE PLASTIC CLIP

FIG. 3

Instructions for Locking/UnLocking Legs

Note: Use these steps after Step 2 of Owner's Manual.

After setting the grill up on all three legs, grab the rod hanging down near each leg. Push the "L" shaped end into the Leg Lock Clip recess to lock.

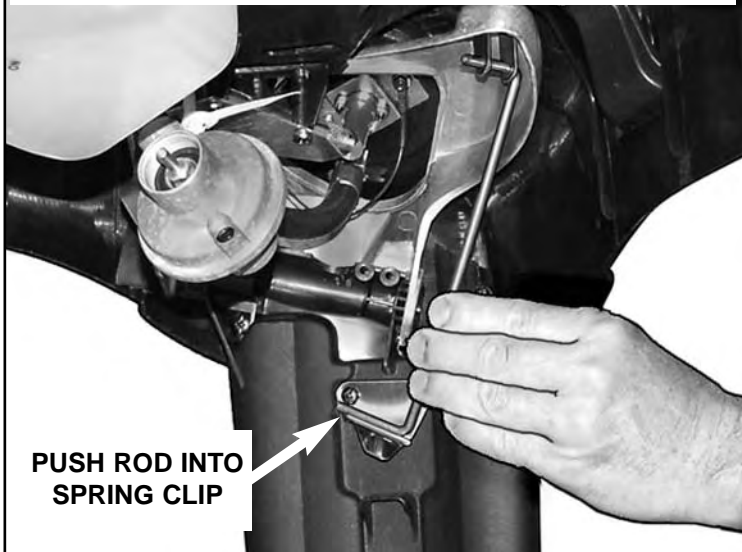

NOTE: Before folding the legs for storage or transport, release the rod from the spring clip and rotate it back into the body cavity.

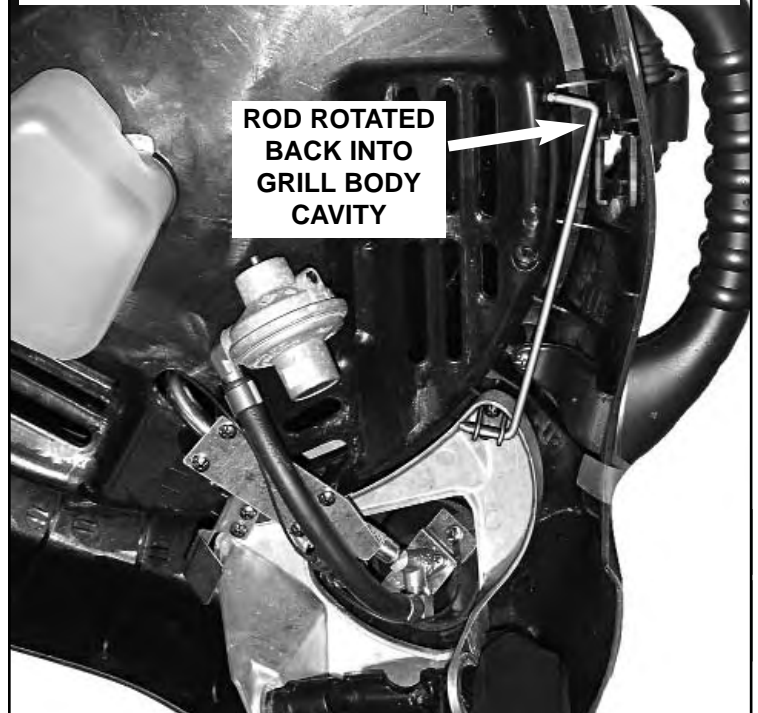

CAUTION

· To avoid leg collapse and damage, do not drag or push your grill.