

This Owner's Manual is provided and hosted by [Appliance Factory Parts](#).



HONEYWELL 63200 Owner's Manual

[Shop genuine replacement parts for HONEYWELL
63200](#)



[Find Your HONEYWELL Air Cleaner Parts - Select From 215 Models](#)

----- Manual continues below -----

Honeywell

enviracaire®

Portable Air Cleaners

READ AND SAVE THESE INSTRUCTIONS

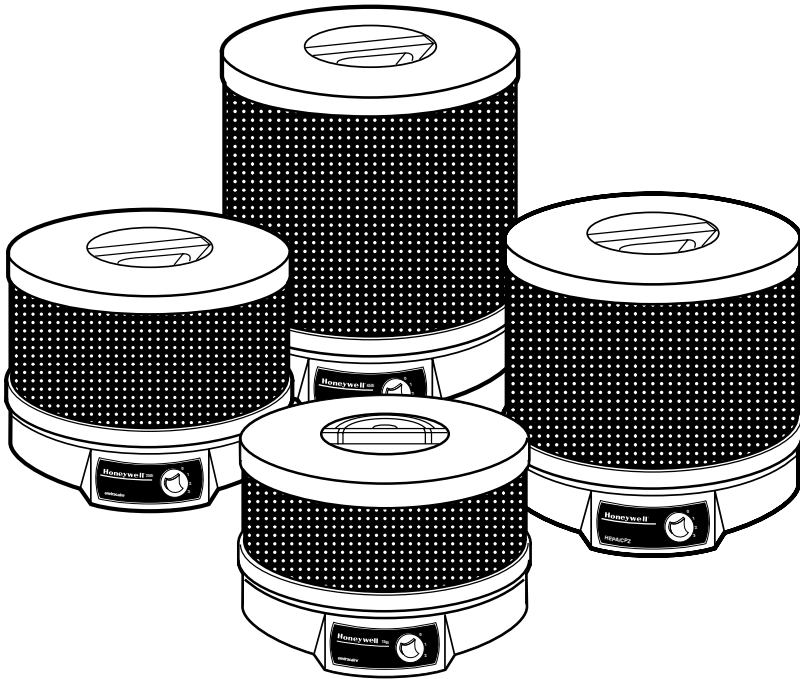

Owner's Guide

For Model Series

61500 • 62500 • 63500 and
64500 Series Air Cleaners

The Science of Clean Air

Congratulations...

You now own a powerful and highly efficient portable air cleaner.

Our customer service center representatives will be pleased to help with any questions or concerns you may have about your Honeywell air cleaner. Please call our Consumer Relations Dept. at (800) 332-1110 for assistance.

Quality/Reliability...

Your air cleaner is quality engineered for simplicity and reliability and is manufactured with durable, high impact plastic housings which are scratch, stain, and corrosion resistant. With reasonable care and replacement of filters as recommended, it will give you years of trouble free performance.

61500 Series ...

The **Honeywell** 61500 Series air cleaner is a 2 speed air cleaner operated by moving the speed control knob on the base from the Off ("0") position to the high ("2") position. Allow the unit to operate for a few seconds at high speed, then leave the control knob in the high position for fast, deep room cleaning, or move the knob to the lower setting for quieter operation. The 61500 Series will clean and recirculate the air in a 13' x 14' room six times an hour (at high speed).

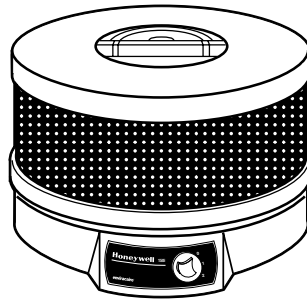

62500 Series ...

The **Honeywell** 62500 Series air cleaner is a 3 speed air cleaner operated by moving the speed control knob on the base from the Off ("0") position to the high ("3") position. Allow the unit to operate for a few seconds at high speed, then leave the control knob in the high position for faster, powerful room cleaning, or move the knob to the lower setting for quieter operation. The 62500 Series will clean and recirculate the air in a 16' x 20' room six times an hour (at high speed).

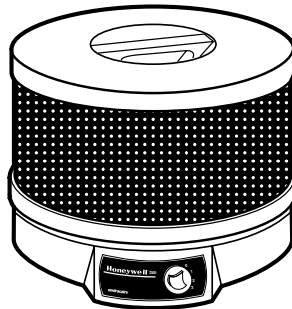

63500 Series ...

The **Honeywell** 63500 Series air cleaner is a 3 speed air cleaner operated by moving the speed control knob in the base from the Off ("0") position to the high ("3") position. Allow the unit to operate for a few seconds at high speed, then leave the control knob in the high position for faster, powerful room cleaning, or move the knob to the lower setting for quieter operation. The 63500 Series will clean and recirculate the air in a 20' x 22' room six times an hour (at high speed).

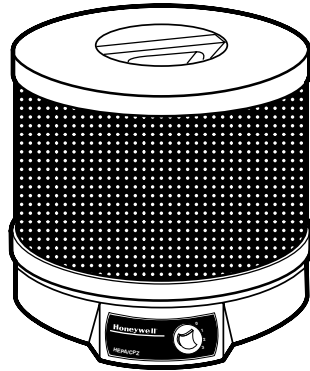

64500 Series ...

The **Honeywell** 64500 Series air cleaner is a 3 speed air cleaner operated by moving the speed control knob on the base from the Off ("0") position to the high ("3") position. Allow the unit to operate for a few seconds at high speed, then leave the control knob in the high position for faster, powerful room cleaning or move the knob to the lower setting for quieter operation. The 64500 Series will clean and recirculate the air in a 22' x 23' room six times an hour (at high speed).

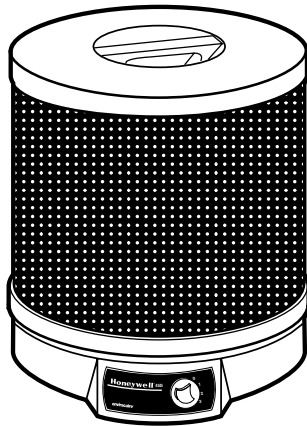

Construction ...

Your **Honeywell** air cleaner has five basic components: the base assembly (with controls and motor), the lid assembly, the protective screen, the HEPA filter, and the activated carbon prefilter.

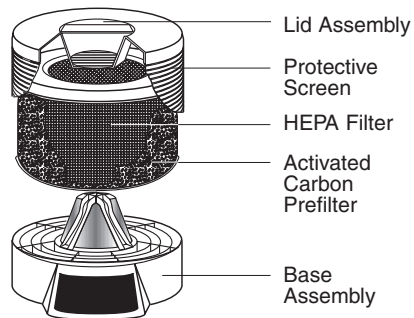

For Best Performance ...

We recommend that you operate your **Honeywell** air cleaner 24 hours a day because indoor air can be quickly contaminated by activity in a room, infiltration of outside air, and generation by sources of contamination.

The **Honeywell** HEPA air cleaner is ready to begin cleaning air as soon as it is removed from the carton and plugged in. Because it circulates air in a 360 degree pattern around the air cleaner, it can be placed on the floor in almost any location. However, for best performance the air outlet slot should not be blocked for at least three feet in all directions.

Replacement Filters...

Select the proper replacement filter for your **Honeywell** HEPA air cleaner from the chart below:

<u>Model No.</u>	<u>HEPA Filter Part Number</u>	<u>Carbon Prefilter Part Number</u>
61500	21500	32002
62500	22500	33002
63500	24000	34002
64500	29500	35002

Replacement filters may be purchased from the retail store or ordered from the dealer where you purchased the product. If you cannot locate one in your area, please call our Consumer Relations Dept. at (800) 332-1110 and we will direct you to a stocking dealer.

Service...

Should your air cleaner require service, please return the complete unit, transportation prepaid to: **Honeywell Consumer Products Business**

Southpoint Distribution Center
4755 Southpoint Drive
Memphis, TN 38118 USA

Filter Replacement...

With proper maintenance, your **Honeywell** air cleaner is designed to provide years of high efficiency air cleaning. Your Honeywell air cleaner contains two filters: one activated carbon prefilter and one primary HEPA filter.

The activated carbon prefilter helps capture large airborne particles, and helps remove odors. The prefilter should be replaced every 3 months. You may need to replace the prefilter more often if the unit is used in a smoking environment or if unpleasant odors persist.

The primary HEPA filter should remain effective for 1 to 3 years, depending upon the environment in which the air cleaner is operating. Honeywell recommends changing the HEPA filter based upon operation conditions—every 3 years for light usage, 2 years for normal usage and 1 year for heavy usage.

Our recommendations regarding filter replacement intervals are intended as guidelines only and are based upon reasonable filter life expectancy in homes with normal levels of particle generation. If there are sources of large amounts of particle generation (such as woodworking or heavy smoking) the useful life of the activated carbon prefilter and HEPA filter in your air cleaner may be reduced .

Whenever the combined air resistance of the activated carbon filter and primary HEPA filter becomes excessive due to the amount of contaminants they have captured, the air cleaner will begin to audibly pulsate. Instead of a steady stream of air, rapid "puffs" of air may be felt at the outlet slot. When this occurs, one of two conditions exists:

1. The activated carbon prefilter is clogged and must be replaced.
2. If the unit continues to pulsate after a new prefilter is installed, the useful life of the HEPA filter has been reached and it must be replaced.

Important...

Replace the activated carbon prefilter at least every 3 months. The activated carbon prefilter is the element of your air cleaner that helps remove odors and gaseous compounds. Under normal household conditions the odor adsorption capability will be used up in about 3 months.

If there are heavy concentrations of odors, smoke, or gases (such as tobacco smoke) in the home, you may need to change the activated carbon prefilter more often.

We **DO NOT** recommend operating the air cleaner without the activated carbon prefilter because the primary HEPA filter does **NOT** absorb odors or gaseous compounds. In fact, the HEPA filter may become contaminated by these odors and begin to omit the odor captured.

CAUTION: Do not attempt to wash either the activated carbon prefilter or the HEPA filter. They are not washable and washing will damage the filters.

How to Change the Filters...

CAUTION: DISCONNECT FROM POWER SUPPLY BEFORE SERVICING

The only two parts requiring any service are the activated carbon prefilter and the HEPA filter. No tools are needed. To change either filter, disassemble the unit as shown.

1. Loosen the carrying handle by turning it counterclockwise and lift lid and protective screen from unit.
2. Lift HEPA filter and activated carbon Prefilter from the base.
3. Remove the two plastic clips from the top and bottom of the activated carbon prefilter and remove it from the HEPA filter cartridge.
4. Wrap the new activated carbon prefilter around the HEPA filter cartridge and secure with plastic clips.

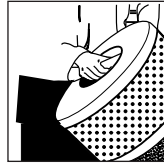
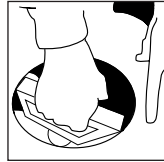

Reassemble your **Honeywell** air cleaner as described below:

1. Place the assembled HEPA filter and the activated carbon prefilter on the base.
2. Replace the lid and protective screen.
3. Reattach the carrying handle and turn it clockwise until securely tightened.

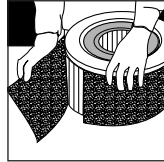

If the Air Cleaner does not operate...

- Check to make sure that the power cord is correctly connected to the outlet.
- Test the outlet with another appliance or lamp.
- Check the fuse or circuit breaker. The outlet may be overloaded if other appliances are also in use. Determine and correct the cause of the overload.
- The thermal overload protection device on the air cleaner's motor may have engaged. Turn the air cleaner's motor control to OFF and wait 30 to 45 minutes. Then, plug it in and turn ON again.
- If none of the above procedures restore operation, return your unit to the store or if the store's return policy does not allow, return the complete unit per the instructions in the service section of this owner's guide. Do not attempt to repair the unit yourself.

Storage...

If you store your **Honeywell** HEPA air cleaner for more than 30 days, we recommend:

- Remove both the primary HEPA filter and the activated carbon prefilter from the unit.
- Discard the prefilter.
- Wrap the HEPA filter in an air-tight plastic bag or plastic wrap. Be sure that the filter is totally sealed.
- To restore the air cleaner to service, unwrap the HEPA filter, install a new activated carbon prefilter, and replace both filters in the air cleaner. (See "How to change the Filters..." section for proper installation.)

Important Safety Instructions...

Please read all instructions before using this product. Save these instructions for easy reference.

When using electrical appliances, basic precautions should always be followed to reduce breakage, risk of fire, electric shock and injury to persons including the following:

1. Read all instructions before operating the air cleaner.
2. Place air cleaner where it is not easily knocked over by persons in the household.
3. Always unplug when not in use.
4. Do not use any product with a damaged cord or plug or if product malfunctions, is dropped or damaged in any manner. Keep the cord away from heated surfaces.
5. Do not use air cleaner outdoors.
6. Never use air cleaner unless it is fully assembled.
7. Do not run power cord under carpets & do not cover with throw rugs. Arrange cord such that it will not be tripped over.
8. Do not use air cleaner where combustible gases or vapors are present.
9. Do not operate the air cleaner near a humidifier or in a bathroom, laundry area or other damp location.
10. To disconnect the air cleaner, first turn speed control to OFF position and remove plug from the outlet.
11. The air cleaner must be used in its upright position.
12. Do not allow foreign objects to enter ventilation or exhaust opening as this may cause electric shock or damage to the air cleaner. Do not block air outlets or intakes.
13. Locate air cleaner near power outlet and avoid using an extension cord.
14. The air cleaner has a polarized plug (one blade is wider than the other). To reduce risk of shock, this plug is intended to fit in a polarized outlet only one way. If the plug does not fit fully in the outlet, reverse the plug. If it still does not fit, contact a qualified electrician. **DO NOT** attempt to defeat this safety feature.
15. Do not sit, stand or place heavy objects on the air cleaner.

Limited Warranty...

Honeywell HEPA Air Cleaner

Model No. 61500, 62500, 63500 and 64500

This product has been engineered and crafted with great care for your satisfaction. **Be sure to fill out and return the enclosed card within 7 days of purchase.**

A. This 5 year limited warranty applies to repair or replacement of product found to be defective in material or workmanship. This warranty does not apply to damage resulting from commercial, abusive, unreasonable use or supplemental damage. Defects that are the result of normal wear and tear will not be considered manufacturing defects under this warranty. **Honeywell Consumer Products Business** is not liable for incidental or consequential damages of any nature. Any implied warranty of merchantability or fitness for a particular purpose on this product is limited in duration to the duration of this warranty. Some states do not allow the exclusion or limitation of incidental or consequential damages or limitations on how long an implied warranty lasts, so the above limitations or exclusions may not apply to you. This warranty gives you specific legal rights, and you also may have other rights which vary from state to state. This warranty applies only to the original purchaser of this product.

B. At its option, Honeywell Consumer Products Business will repair or replace this product if it is found to be defective in material or workmanship. Defective product should be returned immediately to **Honeywell Consumer Products Business**.

C. This warranty does not cover damage resulting from unauthorized attempts to repair or from any use not in accordance with this manual.

© 1998 All Rights Reserved
Honeywell Inc.
250 Turnpike Road
Southborough, MA 01772
AC7134.98

D. This warranty **DOES NOT** cover the prefilter or the HEPA filter except for material or workmanship defects.

E. Return defective product to the following address with a brief description of the problem. Include proof-of-purchase and a U.S. \$10.00/Can \$13.00 check or money order for handling, return packing and shipping charges. Please include your name, address and daytime phone number. You must prepay shipping charges. Mark carton **"Attention Repair Department"**

Ship to:

Honeywell Consumer Products Business
Honeywell, Inc.,
Southpoint Distribution Center
4755 Southpoint Drive
Memphis, TN 38118
U.S.A.

In Canada:

Honeywell Consumer Products Canada
510 Bronte St. South Milton, Ontario
Canada L9T 2X6

If you experience a problem with your Air Cleaner, please see owner's guide for instructions. Please do not attempt to repair the air cleaner yourself. Doing so will void the warranty and could cause damage or personal injury. If the problem still persists, please call:

Honeywell Consumer Products Business
Consumer Relations Dept.
Toll Free 1-800-332-1110.

Business Hours:
Mon.–Fri.. 8:00am–10:00pm (EST)
Sat.–Sun. 8:30am–5:00pm (EST).

Mail Questions or Comments to:

Honeywell Consumer Products Business
Consumer Relations Dept.
250 Turnpike Road
Southborough, MA 01772
U.S.A.

035-02321-000