

This Owner's Manual is provided and hosted by [Appliance Factory Parts](#).



SKUTTLE 216-2 Owner's Manual

[Shop genuine replacement parts for SKUTTLE 216-2](#)



[Find Your SKUTTLE Air Cleaner Parts - Select From 3 Models](#)

----- Manual continues below -----



Skuttle™

Indoor Air Quality Products
Route 10, Box 51 Marietta, Ohio 45750-9213
740-373-9169 800-848-9786
Fax: 740-373-9565

SKUTTLE SELF ADJUSTING MAKE-UP AIR CONTROL MODEL 216

U.S. PATENT: 3982560 CANADA PATENT: 685,597

MAKE-UP-AIR CONTROL

INSTALLATION INSTRUCTIONS

Tools Needed

- 1/8" Drill Bit
- Drill
- Screwdriver
- Tinsnips
- Saw (for wall opening)
- 3/32" Allen Wrench (included).

Cut Opening in The Return Air Plenum

Your Make-Up Air Control is easily mounted on your return air plenum or duct.

1. Before starting to mount your unit, plan where to mount it and the approximate route to the outside wall opening. NOTE: Outside vent should be at least 10 feet from laundry dryer and kitchen or bathroom exhaust openings. This will prevent odors and dirt from entering the supply. Avoid elbows if possible.
2. Attach template (included) level to the return air plenum. Avoid mounting unit near an electronic air filter. Air under 40°F would be detrimental to the operation of an electronic air filter. If this unit must be mounted near an electronic air filter, mount a baffle between the filter and the outside air inlet. Mount the baffle so that outside air cannot directly enter the filter but must mix with the inside air before entering the electronic air filter. Note: This unit is normally mounted horizontally (attached to the side of the plenum), however, **it also operates equally well when mounted vertically** (attached to the top of the plenum).
3. DANGER: MAKE SURE YOU ARE NOT CUTTING OR DRILLING INTO ANY AIR CONDITIONING OR ELECTRICAL ACCESSORIES DURING INSTALLATION. Drill 4 holes shown on template.

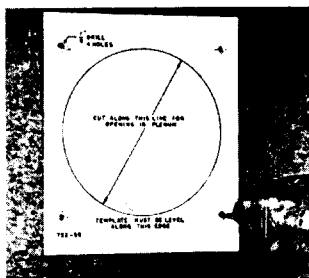

4. Cut out sheet metal within the lines shown on template.

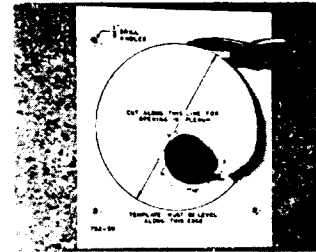

5. Remove remainder of template and mount unit with sheet metal screws.

Cut Opening For Air Intake

1. Select opening for outside air intake. This can be through the wood wall, concrete, brick, plastic panel or even a pane of glass if available. Galvanized metal or a plastic panel can be installed in place of glass. Be sure to secure and caulk metal in window frame. The fresh air duct can be mounted through the ceiling to the attic space where allowed by local codes and if the attic has properly sized outside air openings.
2. Cut the proper size hole for your intake vent. The 6" Make-Up Air Control with 6" connecting pipe will supply 104 CFM @ .10 S.P., 74 CFM @ .05 S.P. of fresh air. The use of elbows and or 4" pipe will reduce these figures.
3. Run connecting pipe & fittings (not provided) from the Make-Up Air Control to the outdoor vent. You may have water condensation collect on this duct in extreme low temperatures. This condition can be corrected by insulating the pipe.

Calibration

The following steps should be taken to calibrate your Make-Up Air Control:

- a. Connect Make-Up Air Control to intake pipe.
- b. Close all outside doors and windows. Make sure other appliances such as water heater, clothes dryer, or exhaust fans are not operating.
- c. Turn thermostat up till furnace blower operates.
- d. Check damper counterbalance arm with blower operating, the arm should point to mid-dial. If arm goes past mid-dial, loosen the Allen screw in the small weight of the Make-Up Air Control and move it $\frac{1}{16}$ " at a time toward the bushing until the balance arm is adjusted to the one-half open position. **If small weight does not correct movement to mid-dial, then move larger weight in same direction $\frac{1}{16}$ " at a time till damper reaches one-half open position. The large weight should not have to move more than $\frac{1}{4}$ ".** Tighten Allen screws; installation is complete.

The fresh air damper will adjust itself to your outside air needs.

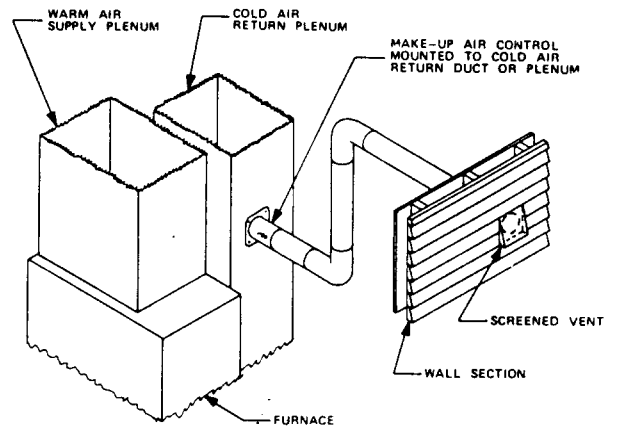

Maintenance

Each year before the heating season, check the damper adjustment. Also inspect the outside air intake to be sure it is free of debris.

IMPORTANT!

Safety Precautions

1. Do not cut or drill into any air conditioning or electrical accessories during Make-Up Air Control installation. Fatal electrocution is possible if you come into contact with a live electrical wire. Blindness can occur if freon contacts your eyes.
2. The installation of this Make-Up Air Control must comply with local codes, ordinances and regulations.
3. Do not install inlet hood near source of contaminated air such as near idling motor vehicles or sewer vents.
4. Read all instructions before installing Make-Up Air Control.
5. Manufacturer assumes no responsibility under warranty if user does not follow stated precautions.

