

Duracraft®

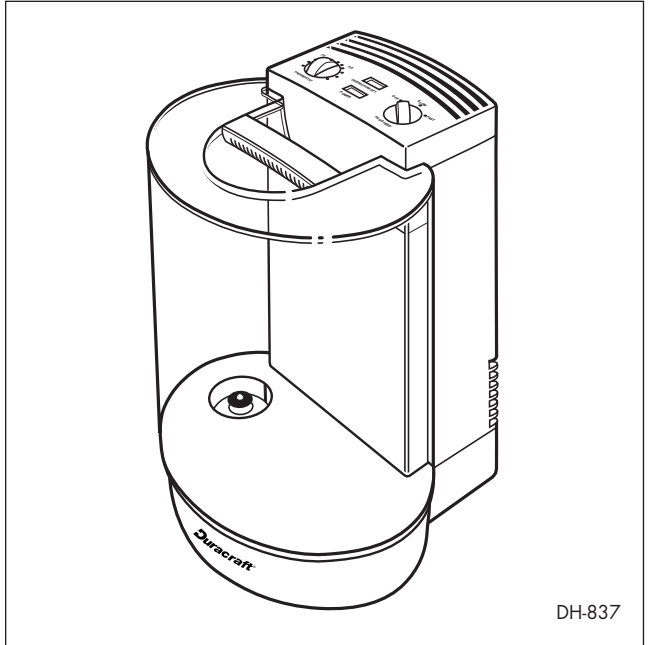

OWNER'S MANUAL

NATURAL COOL MOISTURE™ HUMIDIFIER

Models DH-836 and DH-837

IMPORTANT SAFETY INSTRUCTIONS

READ ALL INSTRUCTIONS BEFORE USING THIS HUMIDIFIER AND SAVE THESE IMPORTANT INSTRUCTIONS FOR EASY REFERENCE.

WHEN USING ANY ELECTRICAL APPLIANCE, BASIC SAFETY PRECAUTIONS SHOULD BE FOLLOWED INCLUDING:

1. Always place this humidifier on a firm, flat and level surface. This humidifier may not work properly on an uneven surface.
2. Place this humidifier in an area where it is not accessible to children.
3. Do not place the humidifier near any heat sources such as stoves, radiators and heaters.
4. Before using the humidifier, check the power cord for any signs of damage. If the cord is found to be damaged, **DO NOT USE** and return the humidifier to Duracraft under the warranty agreement for repair.
5. This product is equipped with a polarized AC-line plug (a plug having one blade wider than the other). This plug will fit into the power outlet only one way. **This is a safety feature. NEVER** connect the humidifier to any power source other than a 120V AC polarized outlet. If you are unable to insert the plug fully into the

outlet, try reversing the plug. If the plug should still fail to fit, contact an electrician to replace the obsolete outlet.

DO NOT defeat the safety purpose of the polarized plug.

6. The humidifier should always be unplugged and emptied when not in operation or while being serviced or cleaned.
7. Never tilt or attempt to move the humidifier while it is operating or filled with water. **UNPLUG** the humidifier before moving.
8. This humidifier requires regular cleaning. Refer to the **CLEANING** instructions provided. Never clean the humidifier in any manner other than as instructed in this manual.
9. Turn the humidifier OFF if the relative humidity exceeds 60%, or if you notice moisture on the inside of your windows. For proper humidity readings use a hygrometer which is available in many hardware and department stores, or by ordering one from Duracraft (see Replacement Parts and Care Products).

INTRODUCTION

Thank you for purchasing a DURACRAFT® NATURAL COOL MOISTURE™ HUMIDIFIER.

Before using your humidifier, we would like to explain the benefits of maintaining your home or office at the proper humidity level.

HEALTH

Your body needs moisture to stay healthy and comfortable. Dry air can be damaging and irritating. The Duracraft® Natural Cool Moisture™ Humidifier can help relieve:

- Dry itchy skin and chapped lips.
- Cold symptoms and congestion.
- Dry, scratchy throat and coughs.

For serious medical conditions, always consult your physician prior to use.

ENVIRONMENT

Maintaining the proper moisture level in your home or office with your Duracraft® Natural Moisture™ Humidifier will also:

- Replace needed moisture in furniture.
- Keep indoor plants moist and healthy.
- Eliminate cracking and dryness in wood furniture and fixtures.
- Minimize static electricity.

HOW DOES IT WORK?

Dry air is pulled through the Natural Cool Moisture™ system and a quiet fan disperses invisible, moisture-balanced air. Unwanted minerals and bacteria from the water are trapped inside the Natural Cool Moisture™ filter. There is no “mist” or excessive condensation emitted.

The Duracraft® exclusive Automatic Moisture Balance System™ increases moisture output when the air is dry and lowers the moisture output when the humidity level is high. This automatically helps to adjust the output for maximum comfort and helps prevent condensation.

SET UP

- Select a firm, level location—at least six inches from any wall for proper air flow and convenient to an electrical outlet.
- Place the humidifier on a water-resistant surface, as water can damage furniture and some flooring. **Duracraft will not accept responsibility for property damage caused by water spillage.**

FILLING

- We recommend that the humidifier be disinfected prior to first use. Please see **CLEANING** instructions.
- Remove the water tank by grasping handle and pulling straight up. Set aside (Fig. 1).
- Open front panel of motor housing. Remove the Natural Cool Moisture™ filter from

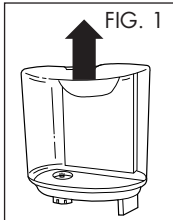

the reservoir base before filling (Fig. 2). Run it under cold water; this will help reduce residue build-up. Turn the filter upside down before repositioning it in the humidifier. To help extend the life of your filter, repeat this step every time you fill your humidifier.

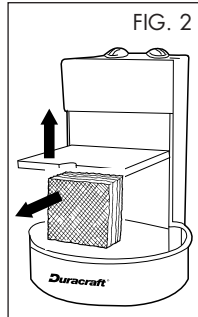

- Turn the Water Tank upside-down so that the fill cap is facing up; unscrew the fill cap by turning it counter-clockwise and set aside.
- Fill the Water Tank with COOL tap water (Fig. 3). Distilled water is not necessary as the water

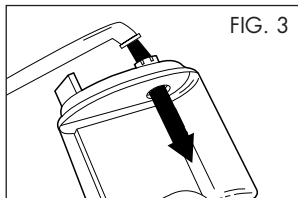

is filtered by the Natural Cool Moisture™ filter. **DO NOT USE HOT WATER.**

- Replace the fill cap by turning it clockwise. **DO NOT OVER TIGHTEN.**

NOTE: WHEN CARRYING THE FILLED WATER TANK, PLEASE USE THE HANDLE AND PLACE YOUR OTHER HAND UNDER THE TANK FOR ADDITIONAL SUPPORT.

- Turn Water Tank right-side up.
- Position Water Tank in the humidifier and push it into place.
- Some water will empty into the Reservoir Base when the filled Water Tank is properly positioned.
- Once the filled tank has been positioned, do not attempt to move the humidifier. If it has to be moved, unplug the humidifier and remove the Water Tank first.

OPERATION

NOTE: DO NOT POUR WATER INTO THE GRILL ON THE FRONT OF THE MOTOR HOUSING. DOING SO MAY DAMAGE THE HUMIDIFIER OR CAUSE PERSONAL INJURY.

• With the power switch in the OFF position, plug the filled humidifier into a polarized 120V outlet.

DO NOT FORCE THE POLARIZED PLUG INTO THE OUTLET; it will only fit one way.

CAUTION: DO NOT PLUG IN THE HUMIDIFIER WITH WET HANDS AS AN ELECTRIC SHOCK COULD OCCUR.

MODEL DH-836

• Set the Moisture Output control to the desired position:

– HIGH for fast humidifying or NORMAL for quieter operation.

• The length of time your humidifier runs will vary depending on the quality of construction and insulation of your room

or house, as well as the Moisture Output speed.

• Turn the humidifier off if the humidity level feels too moist or you notice condensation forming on walls or windows.

• ALWAYS be sure to discard any unused water in the tray each time you refill the Water Tank⁴ or finish using the humidifier (Fig. 4).

MODEL DH-837

• Turn the Humidistat to HIGH - the darkest, largest raindrop.

• Set the Moisture Output control to the desired position:

– HIGH for fast humidifying or NORMAL for quieter operation.

NOTE: IF THE HUMIDIFIER FAN WILL NOT START OR RESTART WHEN YOU SELECT A FAN SPEED, THE HUMIDISTAT MAY BE SET TOO LOW. MOVING THE HUMIDITY LEVEL KNOB TO A HIGHER SETTING SHOULD RESTART THE FAN.

• When a comfortable humidity level is reached, lower the Humidistat setting slowly until the fan stops. The DESIRED HUMIDITY light will illuminate, indicating that the desired humidity setting has been reached. The Humidistat will automatically restart the fan each time the humidity level falls below this setting. This "ON/OFF" cycle will continue periodically while the humidifier is in use.

• ALWAYS be sure to discard any unused water in the tray each time you refill the Water Tank⁴ or finish using the humidifier (Fig. 4).

FIG. 4

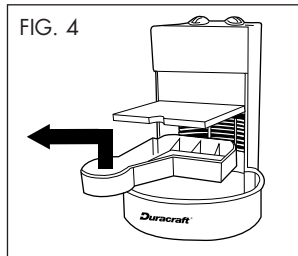

CLEANING

- We recommend that you clean the humidifier once a week, or more often if you:

- have hard water,
- notice a build-up of impurities, or
- detect unpleasant odors.

- Using DuraSept™ Humidifier Bacteriostatic Treatment (#AC-802) will control the growth of bacteria, algae, and odors and help extend the life of the Natural Cool Moisture™ filter.

NOTE: THE USE OF OTHER WATER TREATMENT PRODUCTS MAY CAUSE DETERIORATION OF THE FILTER OR DAMAGE THE HUMIDIFIER; THEREBY, HINDERING THE HUMIDIFIER'S EFFECTIVENESS.

DO NOT USE SOAP, DETERGENTS, OR ABRASIVE CLEANSERS.

- Cleaning involves two steps: SCALE REMOVAL and DISINFECTING. Be sure to perform these in the proper order to avoid harmful chemical interactions.

- First, turn off and unplug the humidifier.

- Then remove the Water Tank by grasping the handle and pulling straight up (Fig. 5).

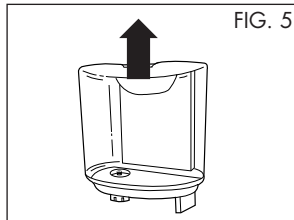

- Open the front panel of the motor housing; reach in and remove the Natural Cool Moisture™ filter (Fig. 6). Set aside.

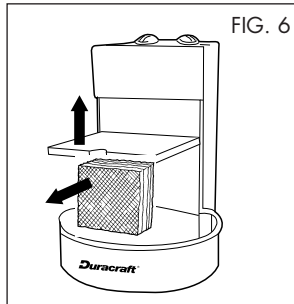

- Remove the Remove and Rinse™ tray by pulling up and out.

- Discard any residual water from the base.

STEP ONE: WEEKLY SCALE REMOVAL (RESERVOIR BASE AND REMOVE AND RINSE™ TRAY)

- Lift the Remove and Rinse™ tray from the unit.

- Fill the Reservoir Base and the Remove and Rinse™ tray with DuraRinse™ Humidifier Cleaner (#AC-816), following bottle instructions, or one 8-oz. cup of undiluted white vinegar. Let solution stay for 20 minutes.

- With DuraRinse™ or vinegar still in the unit, clean all interior surfaces of the base and the Remove and Rinse™ tray with a soft brush or cloth to remove scale.

- Rinse Reservoir Base and Remove and Rinse™ tray thoroughly with clean, warm water to remove scale and cleaning solution.

NOTE: The Remove and Rinse™ tray is dishwasher-safe. If you choose to clean it this way, instead, you may skip the Weekly Disinfecting Step.

STEP TWO: WEEKLY DISINFECTING (WATER TANK, RESERVOIR BASE, AND REMOVE AND RINSE™ TRAY)

- Be sure the Water Tank is empty. Fill with water and DuraRinse™ Humidifier Cleaner (#AC-816), following bottle instructions, or 1 teaspoon chlorine bleach in 1 gallon water. Let solution stay 20 minutes, swishing every few minutes to wet all surfaces.
- Empty tank after 20 minutes. Rinse with water until bleach smell is gone.
- Repeat for the Reservoir Base and the Remove and Rinse™ tray (unless the Remove and Rinse™ tray was cleaned in the dishwasher).

AFTER DISINFECTING...

- Clean all surfaces of the power unit with a dry, soft cloth. DO NOT USE WATER TO CLEAN THE POWER UNIT. THIS MAY DAMAGE THE HUMIDIFIER OR CAUSE ELECTRIC SHOCK.
- If you have hard water you may need to clean or change the filter more often. If the filter is dirty, rinse it under cold tap water and turn the filter upside down before repositioning in the base. Do not squeeze or wring out pad. Do not soak pad in bleach or vinegar. When the filter turns dark brown, replace it. Using DuraSept™ Humidifier Bacteriostatic Treatment will help extend the life of the filter. For best and proven results always use Duracraft® Natural Cool Moisture™ filters available from your local store or from Duracraft.
- Reposition the Remove and Rinse™ tray, Filter, and Water Tank.

NOTE: THE FAN MOTOR OF THIS HUMIDIFIER AND

THE NATURAL COOL MOISTURE™ FILTER ARE DESIGNED TO FUNCTION EFFICIENTLY AS A SET. Using any other filter could damage the humidifier's motor or impair its performance.

END-OF-SEASON CARE AND STORAGE

- Follow weekly CLEANING instructions at end of humidification season or when humidifier will not be used for at least one week or more.
- Remove and throw away the filter; **(SAVE TRAY FOR USE WITH YOUR REPLACEMENT PAD)** do not store with a used filter.
- Let humidifier dry completely before storing. Do not store with water inside the Reservoir Base or water tank.
- Pack the unit in its original carton and store in a cool, dry location.
- Remember to install a new filter and clean the humidifier at the start of the next humidification season.

ELECTRICAL RATINGS

Model DH-836 is rated 0.60 Amps at 120V, 60 Hz.

Model DH-837 is rated 0.75 Amps at 120V, 60 Hz.

NOTE: IF YOU EXPERIENCE A PROBLEM WITH YOUR HUMIDIFIER'S POWER UNIT, PLEASE SEE THE WARRANTY FOR INSTRUCTIONS. PLEASE DO NOT ATTEMPT TO OPEN OR REPAIR THE HUMIDIFIER YOURSELF. DOING SO WILL VOID THE WARRANTY AND

COULD CAUSE DAMAGE OR PERSONAL INJURY. IF THE PROBLEM STILL PERSISTS, PLEASE CALL:

DURACRAFT CORP.
CUSTOMER SERVICE
DEPARTMENT

TOLL FREE: 1-800-554-4558

Business Hours:

Monday – Friday
8:00 AM – 10:00 PM (EST)

Saturday, Sunday
8:30 AM – 5:00 PM (EST)

Mail questions or comments to:

DURACRAFT CORP.
Consumer Relations Dept.
250 Turnpike Road
Southborough, MA
01772
U.S.A.

Please be sure to specify model number.

CARE PRODUCTS

Model AC-802 — DuraSept™ Humidifier Bacteriostatic Treatment helps control the growth of bacteria and algae in your humidifier and helps prevent unpleasant mildew odors. It can also help extend the life of the Natural Cool Moisture™ Filter. For best results, DuraSept™ should be added every time you fill your humidifier.

Model AC-816 — DuraRinse™ Humidifier Cleaner helps soften lime scale and mineral deposits when cleaning the Natural Cool Moisture™ Humidifier. DuraRinse™ should be used whenever you begin to notice discoloration in the humidifier's Reservoir or Water Tank.

Model AC-817 — DuraFree™ Humidifier Water Softener softens hard water impurity

deposits in the Reservoir and on the Natural Cool Moisture™ Filter so they can be easily rinsed away.

Model AC-850 — Humidifier Complete Care Kit A complete care kit for your Natural Cool Moisture™ Humidifier, including one 32-oz. (946ml) bottle of each of the above products: DuraSept™, DuraRinse™ and DuraFree.™

LIMITED WARRANTY

DURACRAFT NATURAL COOL MOISTURE™ HUMIDIFIER

This product has been engineered and crafted with great care for your satisfaction.

Please read all instructions before attempting to use this product. **Be sure to fill out and return the enclosed card within 7 days of purchase.**

A. This 5 year limited warranty applies to repair or replacement of product found to be defective in material or workmanship. This warranty does not apply to damage resulting from commercial, abusive, unreasonable use or supplemental damage. Defects that are the result of normal wear and tear will not be considered manufacturing defects under this warranty. Duracraft is not liable for incidental or consequential damages of any nature. Any implied warranty of merchantability or fitness for a particular purpose on this product is limited in duration to the duration of this warranty. Some regions do not allow the exclusion or limitation of incidental or consequential damages, or limitations on how long an implied warranty lasts, so the above limitations or exclusions may not apply to you. This warranty gives you specific legal rights, and you also may have other rights which vary from region to

region. This warranty applies only to the original purchaser of this product.

B. At its option Duracraft will repair or replace this product if it is found defective in material or workmanship. Defective product should be returned directly to Duracraft.

C. This warranty does not cover damage resulting from any unauthorized attempts to repair or from any use not in accordance with this manual.

D. Return defective product to the following address with a brief description of the problem. Include proof of purchase and a U.S. \$10.00/Can.\$13.00 check or money order for handling, return packing and shipping charges. Please include your name, address and a daytime phone number. You must prepay shipping charges. Mark carton **"Attention Repair Department."** Ship to:

Duracraft Corp.
Southpoint Distribution Center
4755 Southpoint Drive
Memphis, TN 38118
U.S.A.

NOTE: THIS WARRANTY DOES NOT COVER THE NATURAL COOL MOISTURE™ FILTER, WHOSE PERFORMANCE WILL DEPEND UPON THE CONDITION OF THE WATER USED IN THE HUMIDIFIER.

Duracraft®

250 Turnpike Road Southborough, MA 01772