

This Owner's Manual is provided and hosted by [Appliance Factory Parts](http://www.appliancefactoryparts.com).

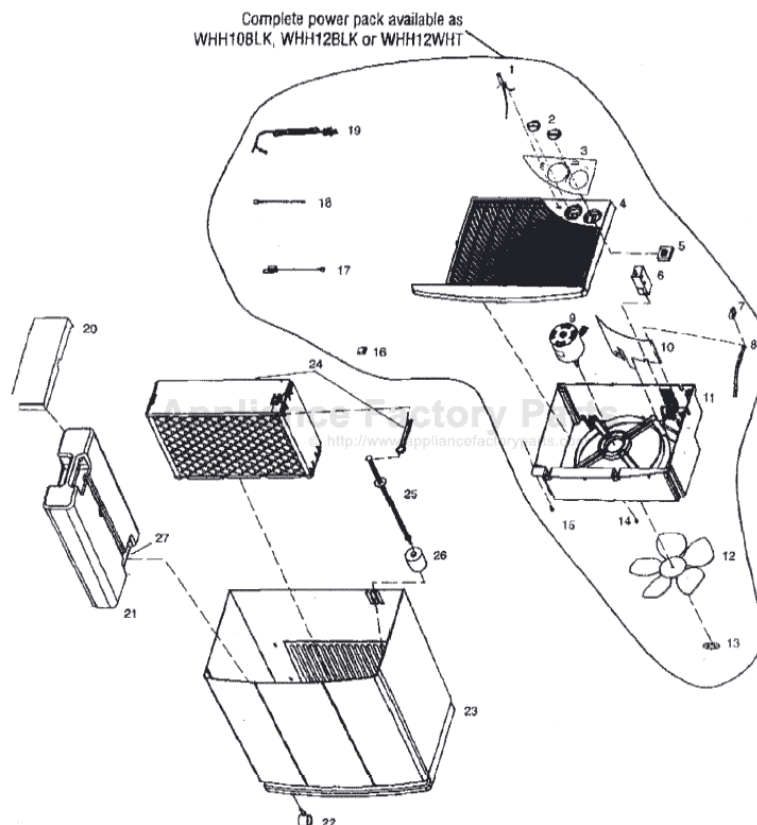

BEMIS H12001 Owner's Manual

[Shop genuine replacement parts for BEMIS H12001](#)



[Find Your BEMIS Humidifier Parts - Select From 274 Models](#)

----- Manual continues below -----

ASSEMBLY

CASTERS

- 4) Turn the emptied cabinet upside down. Insert each caster stem into the four caster holes in each corner of the humidifier bottom. The casters should fit snugly and be inserted until the stem shoulder reaches the cabinet surface. Do not force.
- 5) Turn the cabinet right side up.

EVAPORATIVE WICK

- 6) When placing the wick back into the humidifier, the rod and float assembly must also be reattached. Insert the top of the float rod through the hole in the extended wick retainer (attached to the top of the wick frame) (A). Holding the float in place, lower the wick and float assembly together into the cabinet. The wick has a mounting rib on the top edge which hooks over a rib at the inside back of the cabinet. The white float must be positioned into the pocket in the bottom of the cabinet. (B)

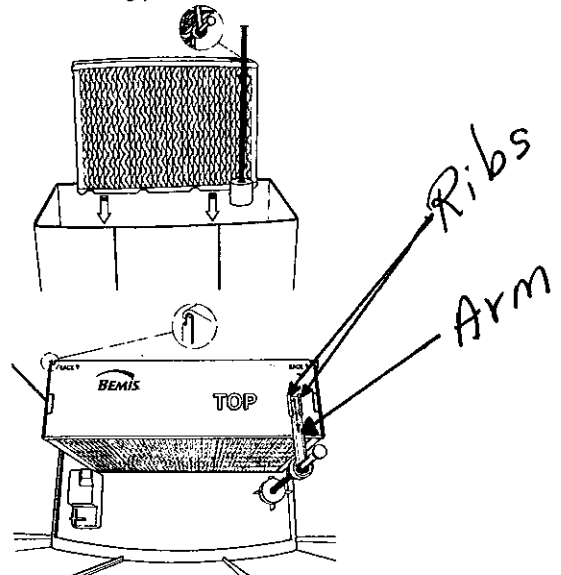

AIR CLEANING FILTER (OPTIONAL)

- 7) The AirCare filter has four tangs that engage into four keyhole slots that mount the AirCare filter onto the outside of the back of the cabinet. (C)

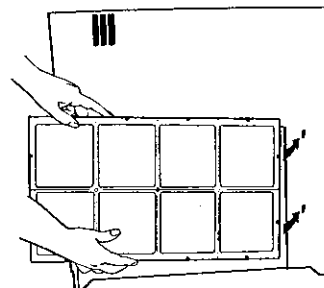

CHASSIS/POWER PACK

- 8) Place the chassis/power pack unit into the cabinet, so it fits without tipping or rocking.

BOTTLE

- 9) Fill the bottle with cool, fresh (preferably unsoftened) water. If you only have softened water available in your home, you can use it, but you will notice a buildup of minerals on the wick much sooner.

The bottle holds 2.5 gallons. When filling, be careful not to pressurize it by overfilling. Bottle damage can result from this. A fill hose is provided with your humidifier which will fit most faucets. **Place the water bottle into**

the left side of the humidifier with the valve cap end down, so

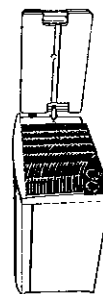

ASSEMBLY

CASTERS

- 4) Turn the emptied cabinet upside down. Insert each caster stem into the four caster holes in each corner of the humidifier bottom. The casters should fit snugly and be inserted until the stem shoulder reaches the cabinet surface. Do not force.

A.

- 5) Turn the cabinet right side up.

EVAPORATIVE WICK

- 6) When placing the wick back into the humidifier, the rod and float assembly must also be reattached. Insert the top of the float rod through the hole on the extended wick retainer (attached to the top of the wick frame) (A). Holding the float in place, lower the wick and float assembly together into the cabinet. The wick has a mounting rib on the top edge which hooks over a rib at the inside back of the cabinet. The white float must be positioned into the pocket in the bottom of the cabinet. (B)

B.

AIR CLEANING FILTER (OPTIONAL)

- 7) The AirCare filter has four tangs that engage into four keyhole slots that mount the AirCare filter onto the outside of the back of the cabinet. (C)

C.

CHASSIS/POWER PACK

- 8) Place the chassis/power pack unit into the cabinet, so it fits without tipping or rocking.

BOTTLE

- 9) Fill the bottle with cool, fresh (preferably unsoftened) water. If you only have softened water available in your home, you can use it, but you will notice a buildup of minerals on the wick much sooner.

D.

The bottle holds 2.5 gallons. When filling, be careful not to pressurize it by overfilling. Bottle damage can result from this. A fill hose is provided with your humidifier which will fit most faucets. **Place the water bottle into the left side of the humidifier with the valve cap end down, so**

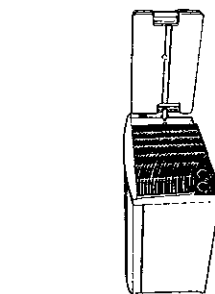
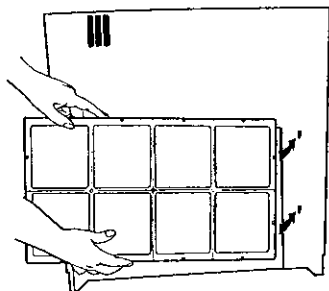
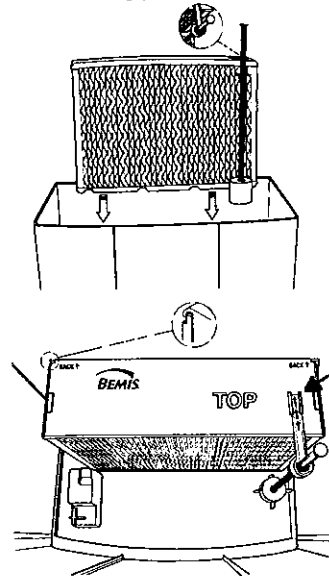

The end of the arm must be flush with (even with) the rear end of the ribs which hold the arm in place.