

This Owner's Manual is provided and hosted by [Appliance Factory Parts](#).



EMERSON HD1303 Owner's Manual

[Shop genuine replacement parts for EMERSON HD1303](#)



[Find Your EMERSON Humidifier Parts - Select From 160 Models](#)

----- Manual continues below -----

CAUTION: Read all instructions carefully before installation.
Save this Owners's Manual for future reference.

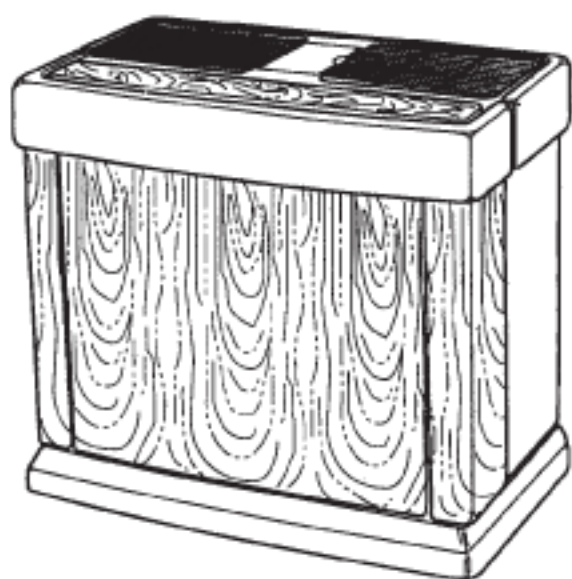

**Model Nos.
HD1300C0C and HD1300WC0C**

EMERSON®

***MoistAIR™* HD1300C/HD1300WC
Evaporative Console
Humidifier Owner's Manual**

Part No. SP6185

Printed in Canada

Repair Parts

PARTS LIST FOR EMERSON HUMIDIFIERS MODEL NOS. HD1300C0C AND HD1300WC0C

Key No.	Model HD1300C0C	Model HD1300WC0C	Description
1	823884	823884	Cover, Dust
2	823730-3	823730-5	Lid, Stationary
3	823724-3	823724-5	Lid, Pivoting
4	826544-1	826544-1	Knob
5	824117	824117	Cap
6	825976	825961	Label, Control
7	826400	826400	Cover, Electronics
8	823910	823910	Switch, Slide
9	824691-3	824691-3	Switch, Variable Speed w/Off
10	825858	825858	Light, Pilot
11	13805-02	13805-02	Humidistat
12	823728	823728	Switch, Micro
13	826401	826401	Enclosure, Electronics
14	824101-1	824101-1	Retainer, Float
15	823712	823712	Float, Water Level
16	824690	824690	"E-Z-Fill Side-Cap"
17	824689	824689	Bottle, Left
18	824688	824688	Bottle, Right
19	822419-2	822419-2	Cap, Assembly
20	823710-5	823710-7	Cabinet
21	823726-2	823726-3	Rail, Kick
22	*	*	* Screw, Pan Hd. Ty "AB" #10 x 3/4
23	822120	822120	Caster, Twin Wheel
24	823849	823849	Support, Filter Lower
25	HDC12C	HDC12C	Filter, Evaporative
26	823714	823714	Support, Upper L.H. Filter
27	825918	825918	Gasket, Form
28	823735	823735	Support, Motor
29	822405-1	822405-1	Motor, Single Speed
30	822405-2	822405-2	Motor
31	822406-1	822406-1	Fan
32	816069-2	816069-2	Screw, Pan Hd. "AB" #6 x 1-3/4
33	823977	823977	Support, Upper R.H. Filter
34	821904	821904	Cord w/Plug
35	826367	826367	Retainer, Micro Switch
36	*	*	* Screw, Pan Hd. Ty "AB" #8 x 3/8
-	SP6185	SP6185	Owner's Manual (not illustrated)

* Standard Hardware Item - May be purchased locally.

Repair Parts

PARTS LIST FOR EMERSON HUMIDIFIERS MODEL NOS. HD1300C0C AND HD1300WC0C

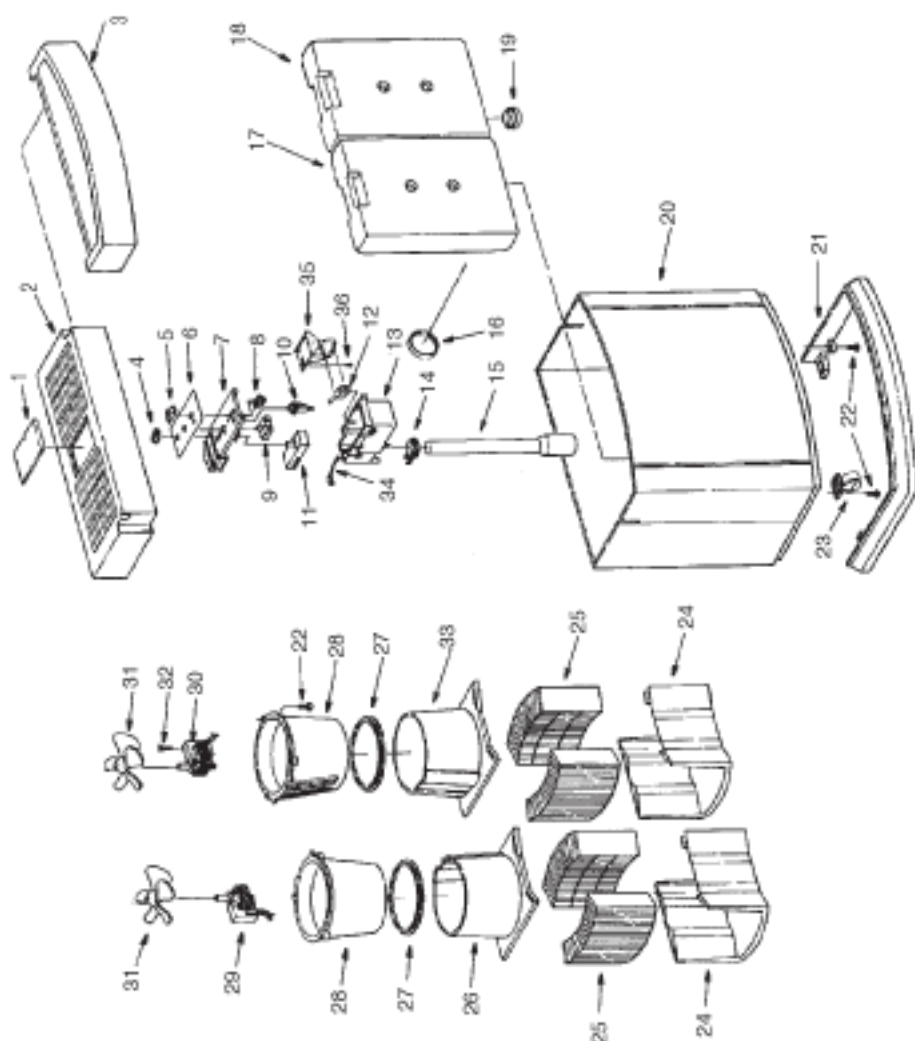

Troubleshooting

TROUBLE	PROBABLE CAUSE	REMEDY
Unit will not run.	<ul style="list-style-type: none"> • Humidity level is too high • No power 	<ul style="list-style-type: none"> • Raise humidistat setting • Check 120 volt source for power
Unit will not shut off	<ul style="list-style-type: none"> • Float is not free 	<ul style="list-style-type: none"> • Free float from obstruction
Unit will not dry out completely	<ul style="list-style-type: none"> • Water is present in the system • High humidity or low temperature resulting in slow evaporation 	<ul style="list-style-type: none"> • This is normal. A small amount of water remains in the cabinet. • Allow unit to continue operation.
Bottles continue to empty	<ul style="list-style-type: none"> • Air is entering water bottles 	<ul style="list-style-type: none"> • Check "E-Z-Fill Side-Caps" to ensure tightness • Check for leak in water bottles • Are gaskets for "E-Z-Fill Side Caps" in place (see repair parts list)
Unit is not emptying	<ul style="list-style-type: none"> • Dirty filters • Bottle cap plunger missing post in bottom of cabinet. 	<ul style="list-style-type: none"> • Change to fresh new filters. • Check orientation of bottle. Reposition so that bottle cap plunger is depressed by post in bottom of cabinet.
Unit runs and shuts off before bottles are empty	<ul style="list-style-type: none"> • Humidity level is too high. • Unit is not setup on a level surface (Float will not sense water at the rear of the cabinet). 	<ul style="list-style-type: none"> • Raise humidistat setting (if possible). • Position unit level (some carpet padding may allow unit to set lower in the front than the rear with the additional weight of water bottles in the front of the cabinet. Install coasters under front casters.

FOR PARTS OR TECHNICAL HELP, CALL (800) 654-3545

FOR MORE INFORMATION ABOUT EMERSON MOISTAIR™ HUMIDIFIERS, VISIT OUR WEBSITE AT www.moistair.com

CAUTION: Use only Emerson WT-BC EPA Registered Bacteriostat available from your local retail store or by calling (800) 654-3545. Use of other water treatment products may damage the filter elements. Under no circumstances should you use water treatment products designed for Rotobelt or Ultrasonic humidifiers.

Cleaning Your Humidifier (continued)

Bi-Weekly Maintenance

Removing Scale

1. Fill the cabinet with one 8 oz. cup of undiluted white vinegar. Let solution stay 20 minutes.
2. Clean all interior surfaces with soft brush. Dampen soft cloth with undiluted white vinegar and wipe out the cabinet to remove scale.
3. Rinse thoroughly with clean warm water to remove scale and cleaning solution before disinfecting the cabinet.
4. Dust the fan assembly and outside surfaces with a soft cloth only.

Disinfecting Cabinet

1. Fill cabinet with 1 teaspoon chlorine bleach in 4 litres of water. Let solution stay 20 minutes, swishing every few minutes. Wet all surfaces normally exposed to water.
2. Empty cabinet after 20 minutes. Rinse with water until bleach smell is gone. Allow unit to dry out completely.
3. Water bottles should be cleaned in same manner.

End of Season Maintenance

1. Follow bi-weekly maintenance instructions at end of humidification season or when humidifier will not be used for at least one week or more.
2. Remove and throw away filters.
3. Let humidifier dry completely before storing. Do not store with water inside cabinet.
4. Store in cool, dry location.
5. Install new filters and clean humidifier before next season begins.

Cleaning Your Humidifier

CAUTION: To reduce the risk of injury, fire or damage to humidifier, use only cleaners specifically recommended for humidifiers. Never use flammable, combustible or poisonous materials to clean your humidifier. To reduce the risk of scalds and damage to humidifier, never put hot water in humidifier.

CAUTION: Local water purity may vary from area to area and under certain conditions water impurities and airborne bacteria may promote the growth of microorganisms in the reservoir of a humidifier.

To retard bacteria growth that may cause odors and be harmful to your health, use only Emerson HDC12C replacement filters. We also recommend using Emerson WT-BC EPA registered bacteriostat, and cleaners specifically recommended for humidifiers available at your local retail store or by calling (800) 654-3545.

NOTE: If it is necessary to use an approved bacteriostat, follow the directions correctly. The bottles of the 49 litre unit will hold 9 litres of water each.

Step 1

To make cleaning easier, the humidifier cabinet should be empty and completely dried out. To accomplish this, use the following method:

- Allow the humidifier to run until the automatic shutoff turns the humidifier "OFF".
- Unplug humidifier

WARNING: If humidifier is not unplugged, fan could start after housing is removed.

- Follow instructions in step 2 "To Remove Parts".

- After removing the parts, dry out the bottom of the humidifier cabinet.
- Proceed to "Bi-Weekly Maintenance" or "End of Season Maintenance".

Step 2

To Remove Parts

- Lift pivoting lid, remove the fan assembly which contains the motors and fans, and set aside. (See Repair Parts list.)
- Remove the water bottles from the cabinet and remove the filter housings (see "Repair Parts" list for identification).
- Remove water level float and empty cabinet.
- Proceed to "Bi-Weekly Maintenance" or "End of Season Maintenance".
- Remove old filters and dispose of properly. Continue to clean cabinet and internal parts as described on next page.

Step 3

Install new filters (purchase Emerson HDC12C Replacement Filter for your humidifier) into the location where the old filters were positioned. Install water level float at back of cabinet. Install the filter housings with the new filters into the correct location. Position the fan assembly on top of the cabinet and return the humidifier to the desired location for use.

Refill humidifier bottles with fresh cool water. Plug the unit into a 120 volt A.C. power outlet and set the controls per the "Operating Humidifier Controls" section of this manual.

Replacement and Care of Filters (continued)

- c. Install new filters in the filter housing track with the glue beads of the wicking pad to the inside of the filter housing.
- d. Return the top cover of the filter housing by installing the cover over the fixed tabs on the rear of the lower filter housing and pivoting the cover down over the top of the filters. Snap the cover over the two spring tabs.
- e. Replace the filter housing in the cabinet. **Note:** There is a left and a right filter housing. There is also a front and back orientation. To position the filter housings correctly:
 - Make sure the two indents in the cylinder section of the top covers are positioned towards the centre of the cabinet.
 - Be sure that spring tabs of filter housings are towards front of cabinet.
 - Align the lower portion of the filter assembly over the six ribs, located at the bottom rear of the humidifier cabinet.
- f. Position fan assembly onto the cabinet. Make sure the fan venturi (lowest cylinder section below the fan) is placed inside the filter housing.
- g. Replace water bottles.
- h. Close the pivoting lid on the fan assembly.
- i. The unit is ready for use or to be stored away for the next season.

NOTE: For correct operation of the filter housing assembly, filters must be fully contained inside the flange of the top cover.

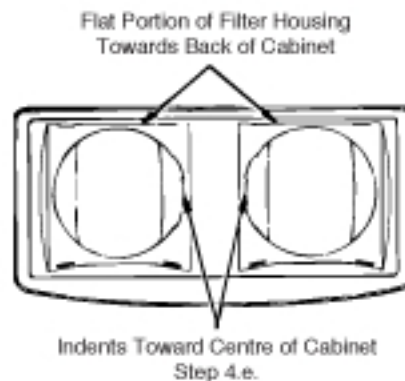
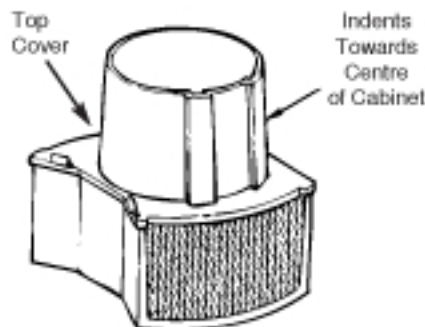
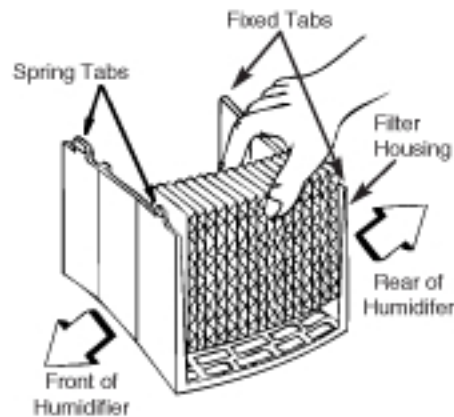

Replacement and Care of Filters

WARNING: To reduce the risk of shock or injury from moving parts, always unplug humidifier before removing or replacing any parts.

CAUTION: To help retard bacteria growth and keep maximum efficiency, the filters should be replaced at least once a season, or more often under hard water conditions. Use Emerson HDC12C recommended replacement filter.

All filters may be rinsed in clear water only. Take care not to damage paper.

To replace the evaporative wicking filters in your Emerson humidifier, follow the instructions below.

1. Unplug humidifier, and proceed to clean. Before removing the filters, we recommend moving the humidifier to an area where floor coverings are not susceptible to water damage, i.e. kitchen or bath areas.
2. Open the pivoting lid and remove water bottles and set aside. Grasp the fan assembly front centre and rear centre. Lift off and set aside on a clean flat surface. The filter assemblies are now accessible.
3. Lift filter housings out of cabinet and place where you may work on them comfortably. With a soft, absorbent cloth, remove any remaining water or loose mineral deposits not trapped in the filter from the humidifier cabinet.
4. To open filter housing for easy access to filters
 - a. Deflect the two spring tabs on top of filter housing. Lift top cover off of the filter housing and set aside.
 - b. Remove the two filters and dispose of properly. Clean internal parts of humidifier per the "Cleaning Your Humidifier" section of your owner's manual.

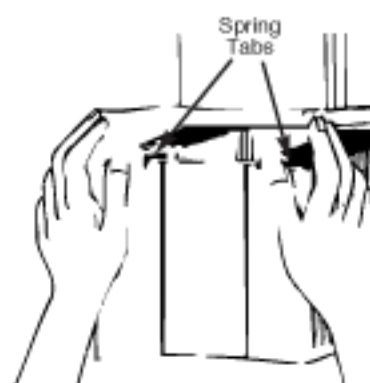
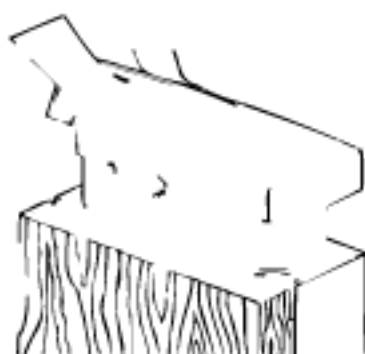

Using Your Humidifier

Step 1

Be sure unit is full of water and plugged in.

Step 2

Set the Fan selection switch to "2". This will allow both fans to operate if the humidistat senses humidity is needed.

Step 3

Set air flow control to MIN.

Step 4

Set Humidity Control to medium position.

NOTE: Humidifier should operate with humidity control on the recommended MEDIUM setting. If it does not, the humidity is at a relatively high level. To test the unit under this condition, turn Humidity Control all the way to the MAXIMUM and unit should begin to operate. After the unit has been tested, set Humidity Control to MEDIUM or desired level.

Allow 24 hours for humidifier to adjust.

If humidity level in home is sufficient, the humidifier will only operate with Humidity Control set on maximum.

IMPORTANT: Water damage may result if condensation starts to form on windows or walls. Humidity Control setting should be lowered until condensation no longer forms.

Step 5

If humidifier stops running, the humidity level is at the normal requirements for that setting or it is adjusting to the home conditions. The table below shows approximate relative humidity percentages (RH%) which correspond to the various settings of the Humidity Control.

The humidity switch shows settings for your 49 litre model.

When Outdoor Temperature is:	Recommended Indoor Relative Humidity is:
-10°F	20%
0°F	25%
10°F	30%
20°F & above	35%

HUMIDITY



Operating Tips for Best Performance

1. Position the humidifier at least 2 inches from any wall and away from any heat registers.
2. Do not restrict airflow from entering or exiting the humidifier.
3. Use Emerson recommended bacteriostat WT-BC to retard bacteria growth that may cause odors and may be harmful to your health.
4. Regular cleaning as instructed in "Cleaning Your Humidifier" section of this manual is recommended.
5. Replace the evaporative wicking filters at least once per humidification season or more depending on water conditions in your area.

Operating Humidifier Controls

The operating controls of your Emerson evaporative humidifier are located on the top centre of the humidifier. The controls are found under the smoked cover, located between the air circulating fans. Lift the control cover by placing your finger in the round cutout and lifting. The cover will stay open. Now you can clearly see the control area. Familiarize yourself with the controls and reference the diagram of the control area for the correct naming used within this manual.

To Operate the Controls

Humidity Control:

Adjust the amount of humidity depending on your needs. The humidifier will turn on and off as required to maintain level of humidity selected. MEDIUM setting is recommended, but there are times when a low or high amount of humidity may be preferred. For constant operation of humidifier, MAX allows for the maximum amount of humidity to be evaporated into the air continuously.

IMPORTANT: Water damage may result if condensation starts to form on windows or walls. Humidity Control setting should be lowered until condensation no longer forms.

Air Flow Control

The unit is adjusted from "OFF" to high to low with a variable speed control.

The higher the air flow speed, the more water is evaporated and released into the air. MIN speed is the quietest and is provided for conditions that may not require as high an evaporation rate. Model HD1300 and DH1300W have a variable speed control (MAX to MIN).

Fill Light

When the unit has a small amount of water left in it, the fill light will come on and the unit will automatically shut off.

Fan Control

Your Emerson humidifier allows a choice to be made for single or dual fan control. The slide switch located closest to the front of the cabinet allows one or two fans to be used. Slide the switch to the "1" position to operate one fan and the "2" position to operate both fans.

The "FAN" slide switch, positioned in the #1 position will operate the humidifier with one fan only in any speed position and provides reduced output at a lower noise level. The "FAN" slide switch positioned in the #2 setting will operate the humidifier with both fans and provides greater output than the single fan settings. Maximum output is provided by the humidifier in the #2 position with the speed control set at high. This combination of infinite number of fan/speed settings allows you to determine the noise level and output level that best suits you.

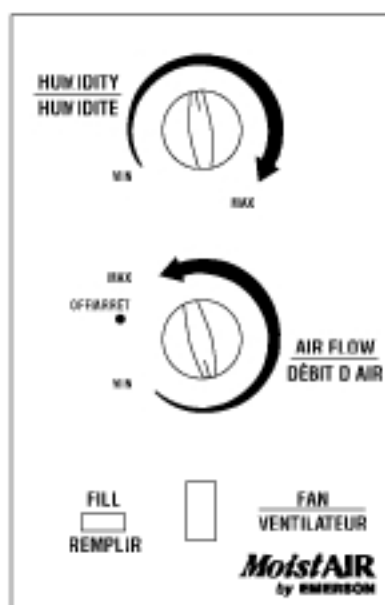

Water Fill (continued)

Open the pivoting lid of the humidifier. Remove the water bottles, lift them straight up and out of the cabinet.

Notice the water bottles are designed as right and left hand units. Position them in the correct location so the humidifier can function properly. The water bottles should rest in the front of the cabinet. Each "E-Z-Fill Side-Cap" must be facing the rear of the unit.

Each water bottle is designed with an "E-Z-Fill Side-Cap" that is easily removable. Remove the "E-Z-Fill Side-Cap" on the side of the water bottle by twisting counterclockwise.

Place the opening of the water bottle under a water faucet (the bottle should fit under a four-inch clearance faucet). Fill with recommended mixture of cold water and Emerson WT-BC Bacteriostat only. Do not add solid debris as this could make the valve leak. Install the "E-Z-Fill Side-Cap" by twisting clockwise. Hand tighten only.

Check for possible leaks by performing the following:

1. Grasp bottle handle and hold the bottle upright over a sink.
2. Press up on valve cap plunger for about one second to let out a little water.
3. Release the plunger.
4. Listen for air bubbles. Look for leaks around "E-Z-Fill Side-Cap".
5. If you hear air bubbles or see leaks, retighten "E-Z-Fill Side-Cap" and repeat steps 1-4.

NOTE: Repeat for other bottle. If either fill cap leaks, water may overflow and leak out of the rear vents of the cabinet.

Wipe off excess water from the bottle. Position the water bottle back into the unit. Grasp the water bottle handle, and lower into the cabinet until the bottle sits on pads at bottom of cabinet. The "E-Z-Fill Side-Cap" must be facing the rear of the cabinet. When positioned properly, the plunger will open and water will flow into the cabinet. The water level will automatically remain at approximately 1/2" until the bottles are empty.

The unit is now ready for operation.

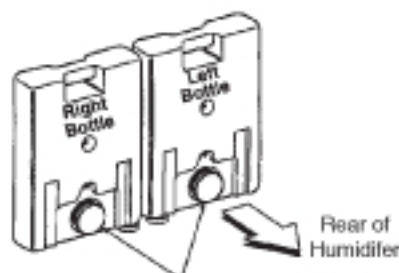

"E-Z-Fill Side-Cap" Should Always Face Rear

Turn Counterclockwise to Remove Cap

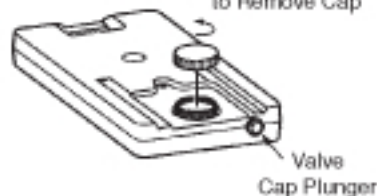

Pivoting Lid Removed for Clarity



Location Instructions

WARNING: For your own safety, do not use humidifier if any parts are damaged or missing.

Step 1

Place humidifier on a flat level surface in area of house where most humidity is needed, or one which would likely result in moist air being circulated throughout the house such as near a cold air return. Placing the unit level is very important if the humidifier is located on carpeting.

NOTE: The 49 litre humidifier contains water bottles. The weight of the bottles in the front of the cabinet may sink the casters deeper in the carpet. This will keep the water level forward in the cabinet. The water level float (located at the rear of the cabinet) may not sense the water and the fill light will be on and the unit will not energize. If this happens, the unit will need to be leveled in order for the humidifier to be energized.

NOTE: It may be necessary to purchase leveling coasters from your local hardware store. The coasters should be positioned under the front two casters of the humidifier.

Moist air (humidity) produced will disperse into the whole house, but area closest to unit will have the highest humidity. If the unit is positioned close to a window, condensation may form on the window pane. If this is not appropriate the unit should be repositioned in

another location.

NOTE: Due to release of cool, moist air from humidifier, it is best to direct air away from home thermostat and hot air registers. It is best to position humidifier next to an inside wall. Hot air registers and cold air from outside walls can affect the efficiencies of the controls. Unit should not be placed where warm air from a hot air register blows directly on unit.

Step 2

The humidifier should be positioned with the back (cord exit side), at least 2 inches away from the wall. Air needs to enter through louvers in the rear panel in order for the humidifier to operate at peak efficiency.

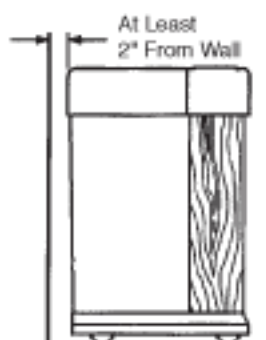

Water Fill

WARNING: To reduce the risk of shock, always unplug humidifier before filling, cleaning, or servicing.

WARNING: To reduce the risk of fire or shock hazard, do not pour or spill water into control or motor area. Close the control cover. If controls get wet, let them dry completely and have unit checked by authorized service personnel before plugging in.

This humidifier is designed to be used with the two water bottles that are located under the pivoting lid.

Pivoting Lid
Removed for
Clarity

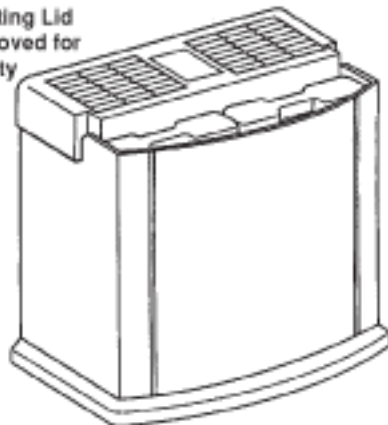

Humidifier Operations

Your new Emerson humidifier is designed to satisfy home humidity requirements through the principle of evaporation of water into the air.

After water is added to the bottles and positioned in the humidifier, the filters begin to soak up the water and become totally saturated in approximately 30 minutes. Air is drawn in from the rear of the humidifier, then passes through the filters by means of two circulation fans. As air passes through the filters, moisture is absorbed into the air and then released through the top of the humidifier. This moist air is released in the form of vapor. No water droplets will enter the home. All evaporation into the air takes place in the humidifier, which means that the residue left by evaporating water is not passed into the home, but remains in the filter.

CAUTION: Emerson WT-BC EPA Registered Bacteriostat available from your local retail store or call (800) 654-3545 to order. Under no circumstances should you use water treatment products for Roto belt or Ultrasonic humidifiers.

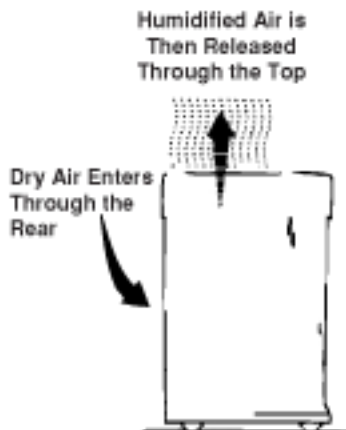

CAUTION: Keep your humidifier clean. While humidifiers do not cause colds, some studies suggest that dirty humidifiers can cause cold-like symptoms in some people. To avoid this, clean your humidifier weekly with cleaners specifically recommended for humidifiers and use Emerson WT-BC EPA recommended bacteriostat.

Assembly

Your new Emerson humidifier is completely assembled for you to use. Remove the packaging material from inside your humidifier and follow the instructions of this owner's

manual for proper usage. The packaging material is located under the fan assembly. Remove the packaging material and discard.

Electrical Hook-Up

Locate nearest 120V A.C. wall socket in the location desired, preferably on inside wall. Plug in the electrical cord.

WARNING: To reduce the risk of fire or shock hazard, humidifier should be plugged into a 120V A.C. outlet. Do not use extension cords.



Know Your Humidifier

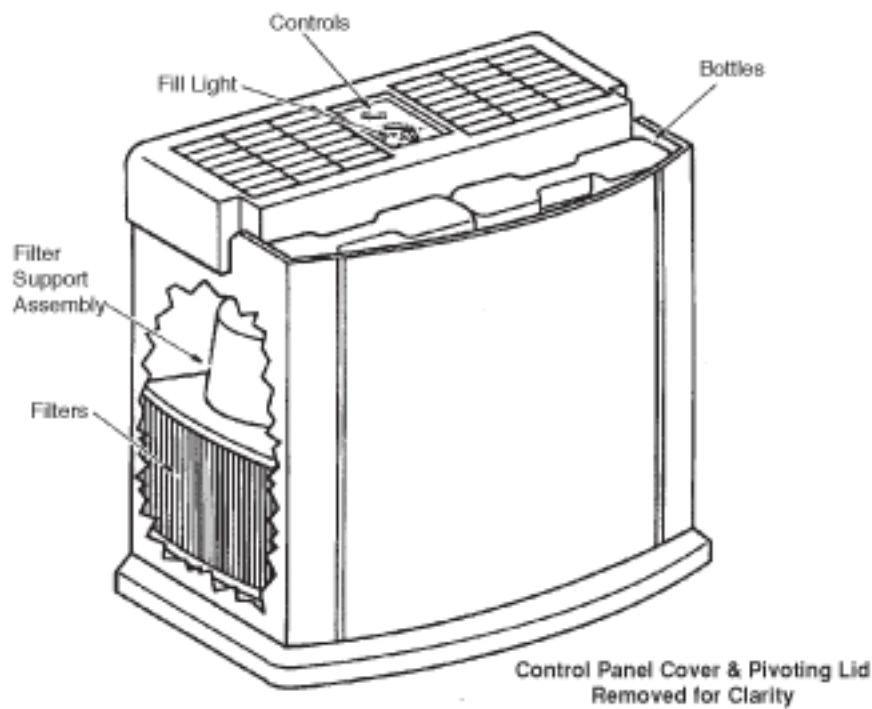

Description	HD1300C	HD1300WC
Litre Output/24 hrs.	49	49
Capacity of Bottles	9 Litres Each	9 Litres Each
Sq. Ft. Coverage	2,715	2,715
Run Time	48 Hours	48 Hours
Fan Speeds	Variable	Variable
Filters	4	4
Fill Light	Yes	Yes
Auto Humidistat	Yes	Yes
Auto Shut Off	Yes	Yes
Dry Out	Manual	Manual
Controls	Rotary	Rotary
CUL Listed	Yes	Yes
AHAM Certified	Yes	Yes
Volts	120 A.C.	120 A.C.
Hertz	60	60
Amps	2.88	2.88
Watts	165	165

Limited Warranty

All products covered by this Owner's Manual are warranted against defects in workmanship and materials for one year from the date of sale except for motors, which are warranted for two years. This warranty does not apply to damage from accident, misuse or alteration nor where the connected voltage is more than 5% above the nameplate voltage, nor to the equipment improperly installed or wired or maintained in violation of this Owner's Manual. No other written or oral warranty applies. No employee, agent, dealer or other person is authorized to give any warranties on behalf of Emerson Electric.

The customer shall be responsible for all costs incurred in the removal or reinstallation and shipping of the product for repairs. Within the limitations of this warranty, inoperative units should be returned, freight prepaid to the nearest Emerson authorized service centre, or the Emerson Electric Co. Service Centre, and we will repair or replace, at our option, at no charge to you with return freight paid by Emerson. It is agreed that such repair or replacement is the exclusive remedy available from Emerson Electric Co. and that **Emerson is Not Responsible For Damages Of Any Kind, Including Incidental And Consequential Damage.** Some provinces do not allow the exclusion or limitation of incidental or consequential damages, so the above exclusion or limitation may not apply to you.

The warranty gives you specific legal rights, and you may also have other rights which vary from province to province.

For the address of your nearest authorized service centre, call 1-800-654-3545.

SALES RECEIPT REQUIRED AS PROOF OF PURCHASE FOR WARRANTY CLAIMS.

GENERAL SAFETY INSTRUCTIONS

Safety Signal Words

DANGER: means if the safety information is not followed someone **will** be seriously injured or killed.

WARNING: means if the safety information is not followed someone **could** be seriously injured or killed.

CAUTION: means if the safety information is not followed someone **may** be injured.

1. To reduce the risk of fire or shock hazard, plug humidifier directly into a 120V, A.C. electrical outlet. Do not use extension cords.
2. Keep the electric cord out of traffic areas. To reduce the risk of fire hazard, never put the electric cord under rugs, near heat registers, radiators, stoves or heaters.
3. Always unplug the humidifier before moving it, removing the fan assembly section, before cleaning, or whenever the humidifier is not in service.

4. Keep the humidifier clean.
5. Do not put foreign objects inside the humidifier.
6. Never use your humidifier while any part is missing or damaged in any manner.
7. To reduce the risk of electrical hazard or damage to humidifier, do not tilt, jolt or tip humidifier over while unit is running.
8. To reduce the risk of damage to humidifier, unplug humidifier when water bottles are empty or when the humidifier is not in use.
9. To reduce the risk of accidental electrical shock, do not touch the cord or controls with wet hands.
10. Note the warning label shown below and on the humidifier.

WARNING: To reduce the risk of fire, electric shock, or injury always unplug before filling, servicing or cleaning.

FOR PARTS OR TECHNICAL HELP, CALL
(800) 654-3545
(Please have complete model number)

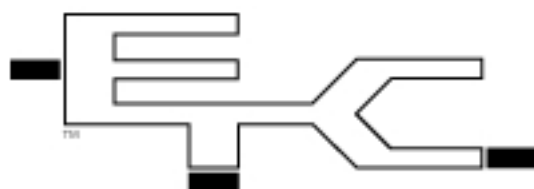

EMERSON TOOL COMPANY
9999 Highway 48
Markham Ontario Canada L3P 3J3