

This Owner's Manual is provided and hosted by [Appliance Factory Parts](#).



COOLERATOR AK4000XZ0 Owner's Manual

[Shop genuine replacement parts for COOLERATOR
AK4000XZ0](#)

[Find Your COOLERATOR Dehumidifier Parts - Select From 14 Models](#)

----- Manual continues below -----

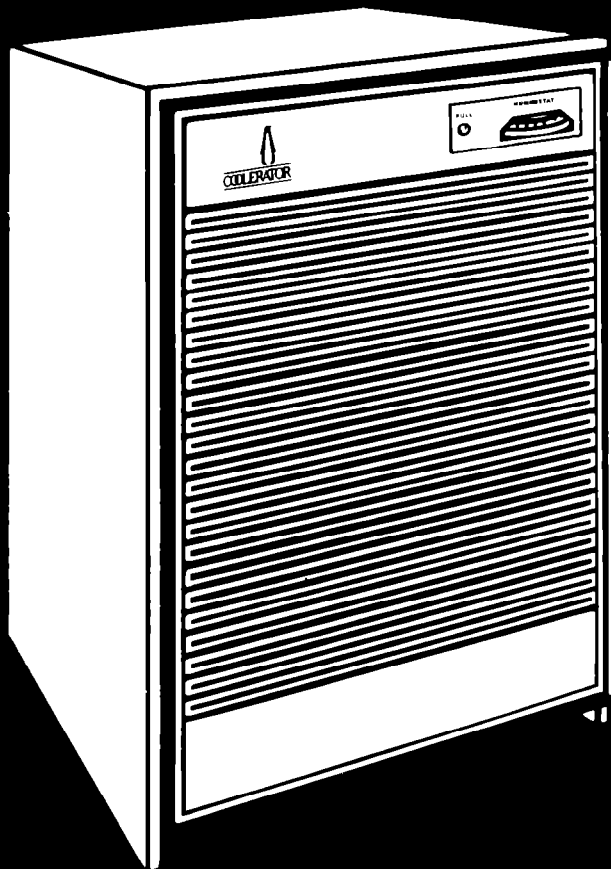

COOLERATOR[®]
DEHUMIDIFIERS

Operation Guide

Contents

	Page		Page
Parts and features	2	Setting the Water Level	
Before using your dehumidifier	3	Adjustment	6
Install properly	3	Water disposal	7
Electrical requirements	4	Caring for your dehumidifier	8
Using your dehumidifier	5	If you need service or assistance	10
To operate	5	Coolerator dehumidifier warranty	12

©1989 Whirlpool Corporation

Parts and features

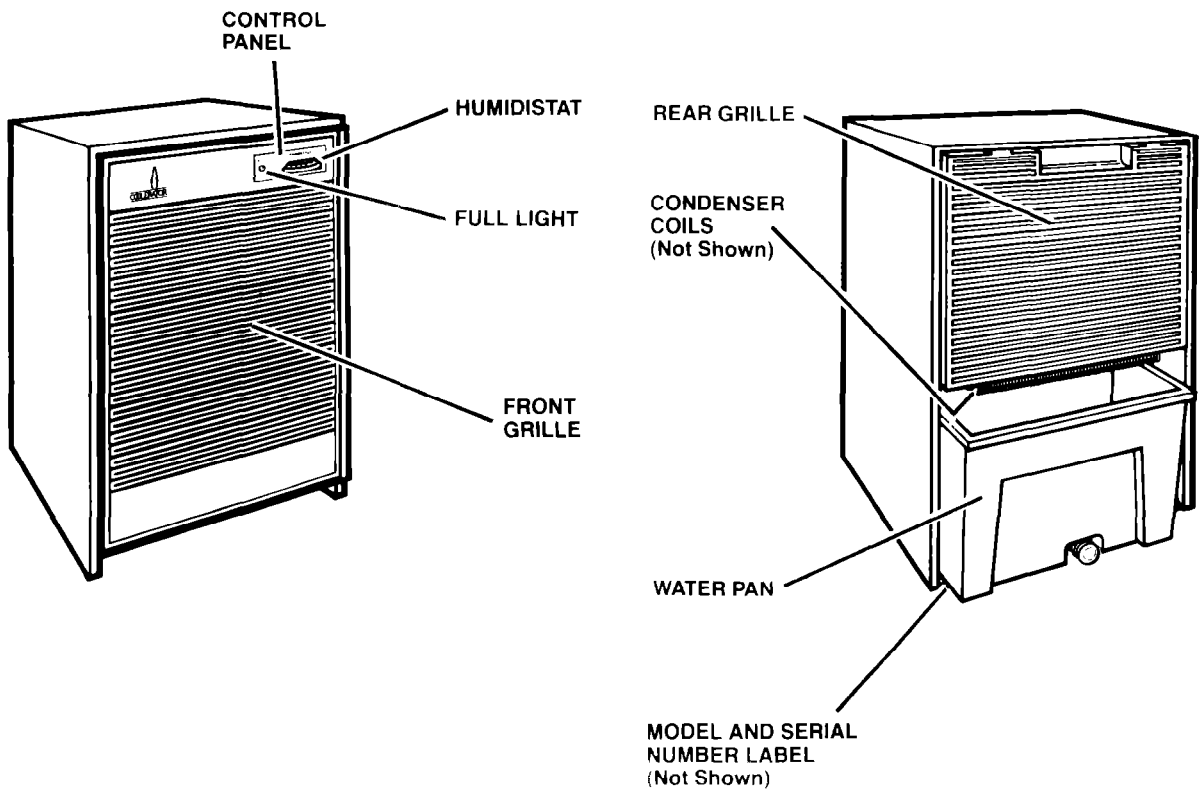

Before using your dehumidifier

This booklet tells you how to install your dehumidifier, use it and clean it. Treat your new dehumidifier with care. Use it only to do what home dehumidifiers are designed to do.

Copy your model and serial numbers here...

If you need service or call with a question, have this information ready:

1. Complete model and serial numbers (from the label under the water pan on the base of the unit.)

2. Purchase date from sales slip.

Copy this information in these spaces.
Keep this book and your sales slip together in a handy place.

Thank you for purchasing a Whirlpool product. Please complete and mail the Owners Registration Card furnished with this product.

Model Number

Serial Number

Purchase Date

Service Company Name and Telephone Number

It is your responsibility to make sure your dehumidifier:

- Has been properly installed on a floor that is reasonably level.
- Is the right size for the area you want to dehumidify.
- Is connected to the right kind of outlet, with the proper electrical supply and grounding. (Refer to your "Electrical Requirements.")
- Is used only for jobs expected of home dehumidifiers.
- Is not used by children or anyone not able to operate it properly.
- Is properly maintained.
- Is used in an area where the room temperature will not fall below 65° F (18.3° C).
- Do not remove Tech Sheet which is inside the cabinet. Your service technician needs this information.

Install properly...

1. There are two rollers under your dehumidifier to help you move it more easily. Remove the water pan. Tilt unit forward and roll to another position.

2. Allow at least 12 inches (30.5 cm) of space around the unit for good air circulation.

3. Keep all outside doors, windows and other openings closed when dehumidifier is operating. Humid outdoor air will add to the dehumidifier's operating load.

4. Water pan must be properly positioned, on the hangers inside the cabinet, when dehumidifier is operating in order for automatic shut-off to operate correctly.

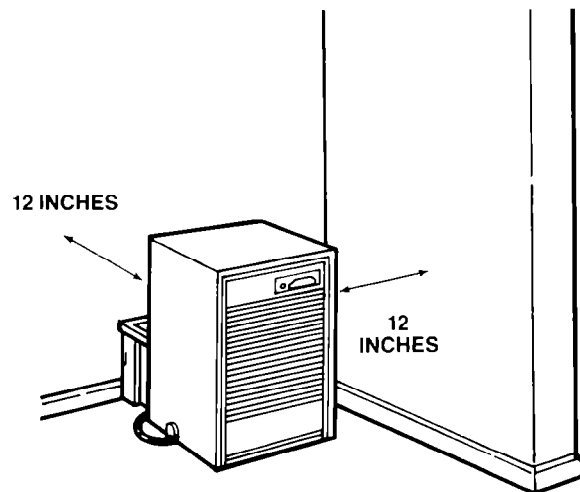

Electrical requirements

OBSERVE ALL GOVERNING CODES AND ORDINANCES.

Electrical ground is required on this appliance.

A 115 volt, 60 Hz., AC only, 15 or 20 ampere fused electrical supply is required. (Time delay fuse or circuit breaker is recommended.) It is recommended that a separate circuit serving only this appliance be provided. **Do not use an extension cord.**

DO NOT UNDER ANY CIRCUMSTANCES, REMOVE THE POWER SUPPLY CORD GROUND PRONG.

RECOMMENDED GROUNDING METHOD

For your personal safety, this appliance must be grounded. This appliance is equipped with a power supply cord having a 3-prong grounding plug. To minimize possible shock hazard, the cord must be plugged into a mating 3-prong grounding type wall receptacle, grounded in accordance with the National Electrical Code and local codes and ordinances. If a mating wall receptacle is not available, it is the personal responsibility and obligation of the customer to have a properly grounded 3-prong wall receptacle installed by a qualified electrician.

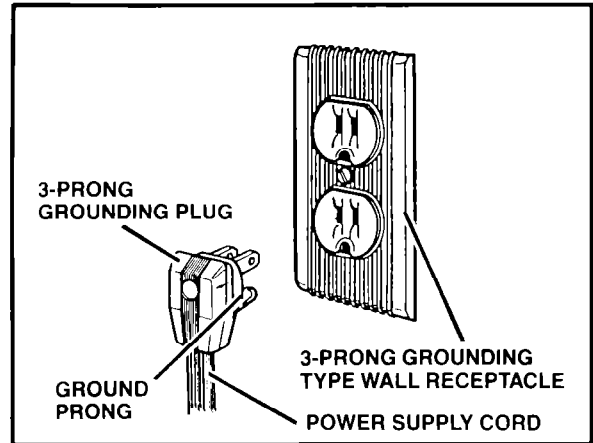

TEMPORARY GROUNDING METHOD

If changing and properly grounding the wall receptacle is impossible and where local codes permit (consult your electrical inspector), a temporary adaptor may be plugged into the existing 2-prong wall receptacle to mate with the 3-prong power supply cord. **THIS HOWEVER, IS NOT RECOMMENDED.**

If this is done, you must connect the grounding eyelet on the adapter to the wall receptacle cover plate screw and from this same screw, you must connect a separate copper ground wire (#14 minimum) to a grounded cold water pipe.* **Do not ground to a gas supply pipe. Do not connect to electrical supply until appliance is permanently grounded.**

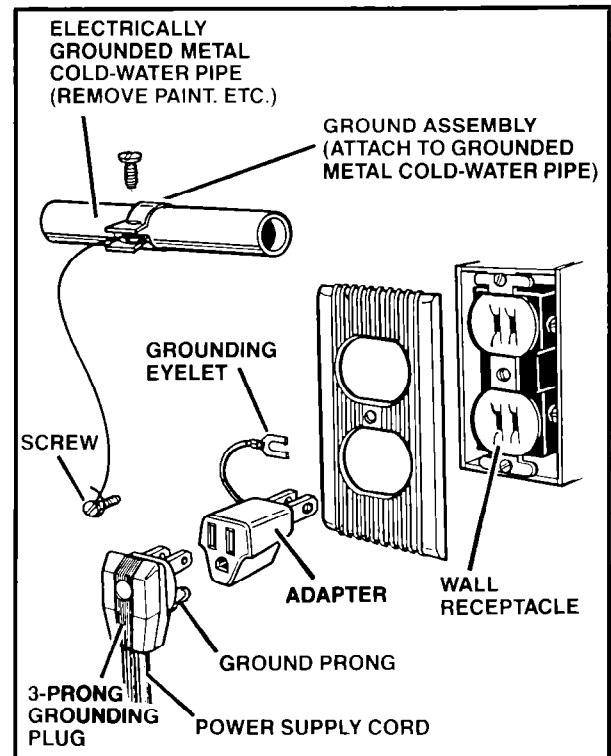

*Cold water pipe must have metal continuity to electrical ground and not be interrupted by plastic, rubber or other electrical insulating connections (including water meter or pump) without adding a jumper wire at these connections.

Using your dehumidifier

You will use your dehumidifier more during months when you're not heating your home. But your dehumidifier can help prevent excessive moisture and keep you comfortable all year in any area of your home.

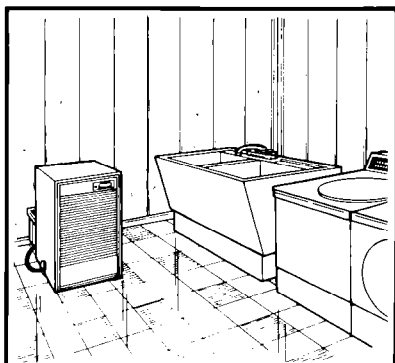

Use in a basement to help prevent moisture damage.

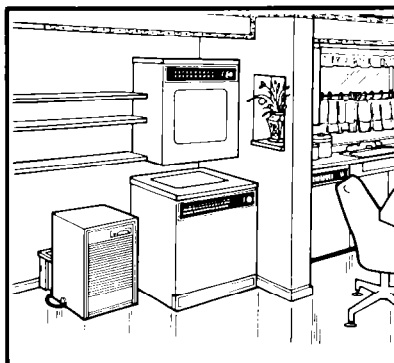

Use in cooking, laundry, bathing and dishwashing areas which have excess moisture.

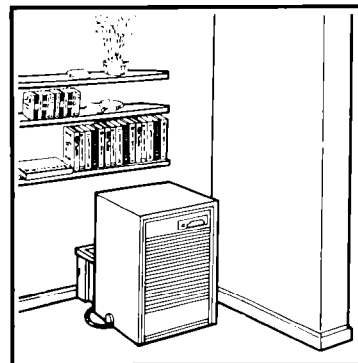

Use to prevent moisture damage anywhere books or valuables are stored.

NOTE: Do not operate your dehumidifier in temperatures below 65°F (18.3°C). The coil may become iced over at low temperatures and it will not operate properly.

Your dehumidifier has a **FULL Light**. The light glows when the pan is full of water to indicate that it needs emptying.

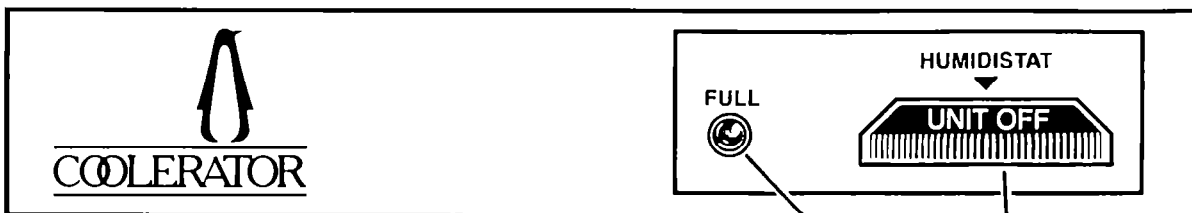

To operate:

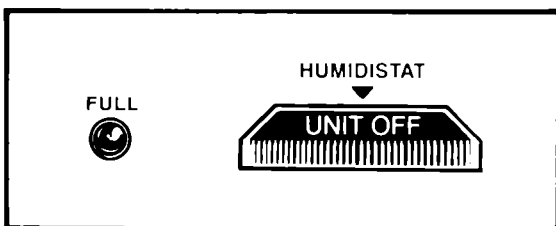

1. Turn Humidistat Control to UNIT OFF, then plug in the dehumidifier.

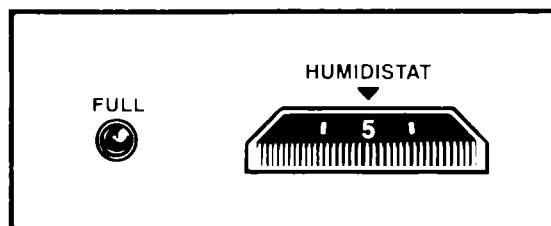

2. Your dehumidifier has an **automatic humidistat**. Turn Humidistat Control left toward DRYEST for normal operation. Set at number 5 or 6 to start. Adjust later, if necessary.

When humidity in the room increases, the dehumidifier automatically starts. When the humidity decreases to the selected level, the dehumidifier automatically stops.

Continued on next page

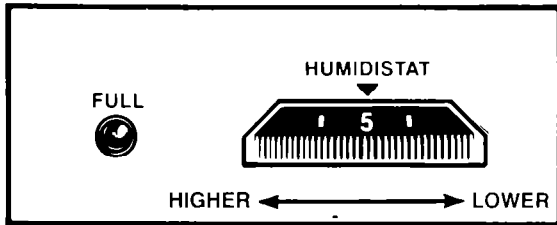

3. If you need more dehumidification, turn control to a higher number. Unit will run continuously at DRYEST setting. If you need less, set on a lower number.

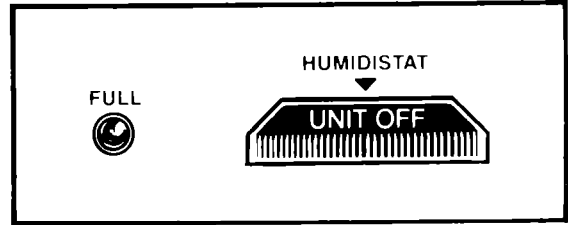

4. Stop the unit manually by turning the control to UNIT OFF.

Setting the Water Level Adjustment

The Water Level Adjustment can be set in two positions to automatically turn off the unit when the pan is full. This prevents the danger of overflow.

Pan must be in proper position for Water Level Control Switch to work.

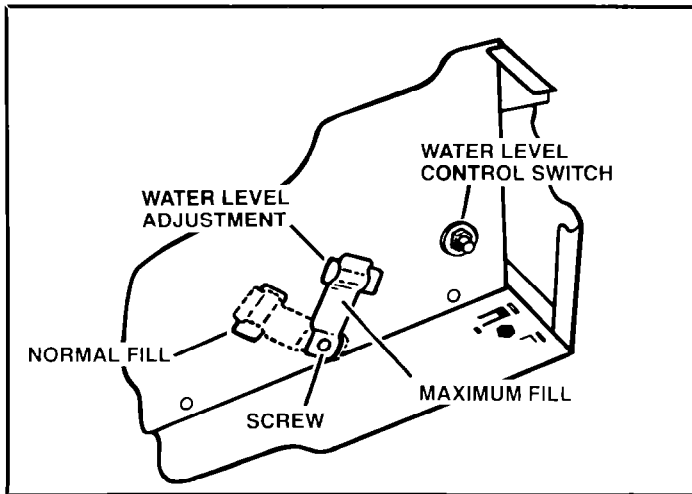

NORMAL FILL –

Water Level Adjustment set on the left side indentation. The water pan and water will weigh approximately 16 lbs. (7.2 kg).

MAXIMUM FILL –

Move the Water Level Adjustment to the raised area on the right side. The water pan and water will weigh approximately 24 lbs. (10.8 kg).

The Water Level Control Switch will automatically turn off the dehumidifier at the fill level you selected when pan is properly placed. Loosen the screw to move the Water Level Adjustment. Retighten screw when adjusted.

Water disposal

⚠ WARNING: Do not use the water that collects in the water pan for drinking purposes. It is not sanitary and could cause illness.

This unit has a 24 pint (11.3L) capacity water pan. There are three methods of disposing of water.

1. Empty pan manually.

When pan is full, remove it, empty it and put it back in place. **Be sure pan is properly placed so the Water Level Control Switch will work to automatically shut off the unit.**

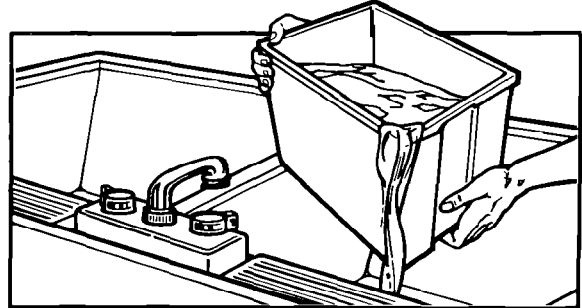

2. Place unit directly over drain.

Pan has a threaded hose connection which can be left open. Cut out opening with a knife or $\frac{3}{4}$ " wood drill.

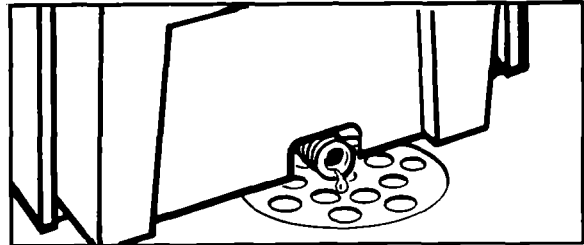

3. Attach garden hose to the threaded hose connection to carry water to drain.

- Pan has a threaded hose connection which can be left open. Cut out opening with a knife or $\frac{3}{4}$ " wood drill.
- Attach garden hose. Be sure hose does not kink or bend. It should lie flat from unit to drain.

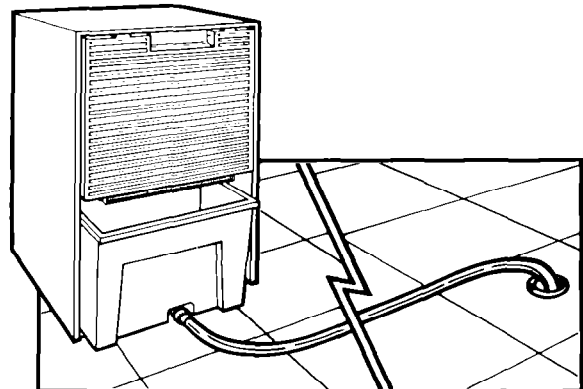

Caring for your dehumidifier

Your dehumidifier is designed to serve you year-round. It needs practically no attention. However, you should check your dehumidifier and inspect the coils annually. Follow these instructions carefully.

You may call a service company to perform this annual checkup or you can do it yourself. Cost of annual inspection is the owner's responsibility.

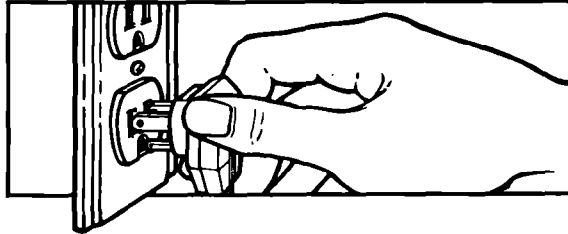

⚠ WARNING: Disconnect power supply cord from receptacle before performing any maintenance. Failure to follow these instructions could cause personal injury.

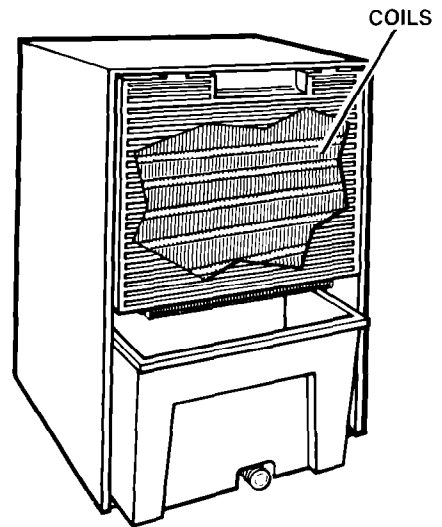

1. To remove outer cabinet:
 - a. Disconnect power cord.
 - b. Take off the plastic grille. Remove the two screws at the bottom. Drop grille down and take out.

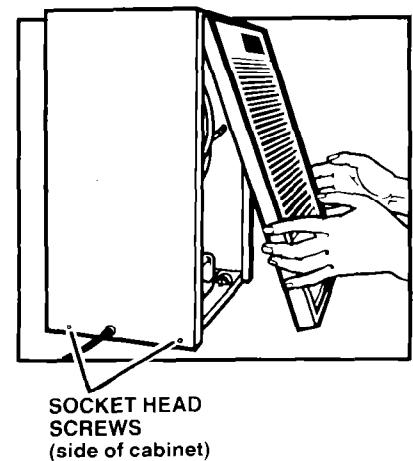
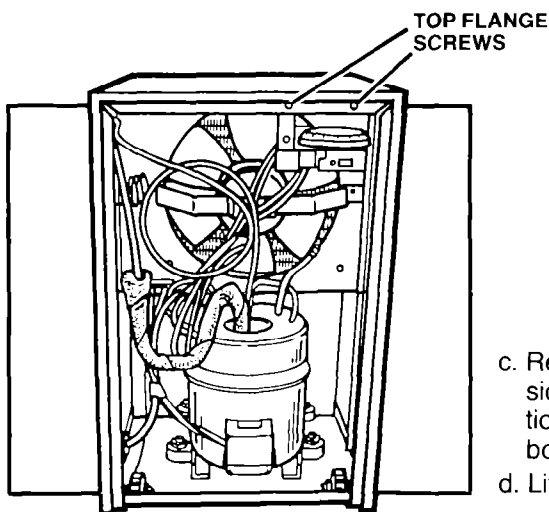

- c. Remove the socket head screws on each side and top flange screws (see illustrations). Also remove rear grille. Pull out at bottom and drop grille down.
- d. Lift cabinet from unit.

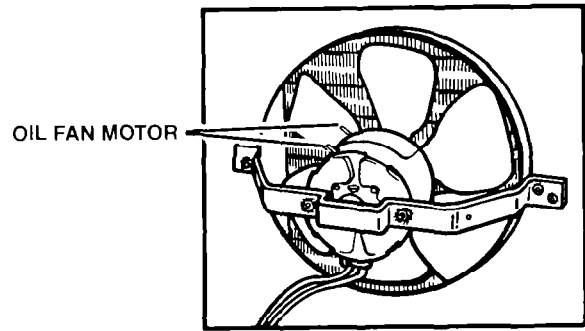
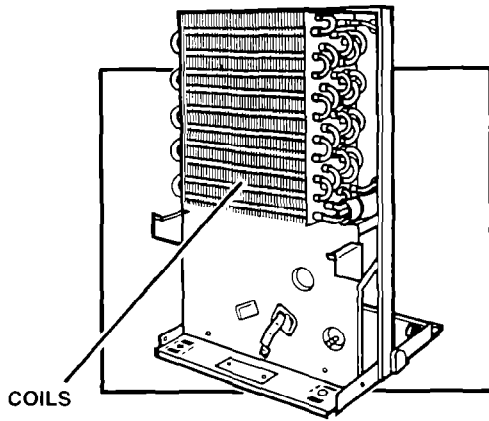

2. Coils should be inspected annually. Brush clean, if necessary, with warm water and mild detergent. Rinse and dry. **Be sure power supply cord is disconnected.**

⚠ WARNING: Be careful when cleaning the coils. Fins are sharp and could cause personal injury.

3. The compressor is sealed and needs no oiling. **The fan motor is prelubricated and does not require further oiling under normal operating conditions.** However, if the dehumidifier is operated under severe environmental conditions (dust, dirt, high temperatures) the fan motor should be oiled annually. Follow the instructions in step 4.

4. Oil the motor through the tubes provided. An easy to use capsule of especially recommended oil (Part Number 10943) is available through your nearest Whirlpool Factory Service Center, or use SAE #20 non-detergent oil.

5. Wash plastic parts with a soft cloth, warm water and mild detergent. Rinse and dry with a soft cloth.

6. Replace cabinet and grille(s). Reconnect power supply cord.

If you need service or assistance, we suggest you follow these five steps:

1. Before calling for assistance...

Performance problems often result from little things you can find and fix yourself without tools of any kind.

If unit won't operate

- Is the dehumidifier correctly plugged into a live circuit with the proper voltage?
- Is the Humidistat Control set to a position other than UNIT OFF? Try a dryer setting.
- Have you checked the main fuse or circuit breaker box?

If unit blows fuses or trips circuit breakers:

- Are correct time-delay fuses being used in the main fuse box?
- Is an extension cord being used? **Do not use an extension cord.**
- Are the coils iced or clogged with lint?

If unit ices up:

- Is humidity too low?
- Is room temperature below 65°F (18.3°C)?
Coil will become iced over at low temperatures.

If water collects on the floor:

- Is unit reasonably level?
- Is hose or drain clogged or kinked?
- Is the water pan overflowing? Pan must be properly positioned.

Special dehumidifier needs:

- Annual inspection: Clean coils, inspect drain and hoses. If necessary, oil the fan motor.
- Moving: When moving, keep the unit in an upright position.

Remember... Please include the model and serial number of your appliance when requesting service. Also, retain your sales slip and warranty to verify your warranty status. Learn the benefits of using TECH-CARE® service for maintaining the quality originally built into your WHIRLPOOL appliance.

2. If you need assistance*...

Call Whirlpool COOL-LINE® service assistance telephone number. Dial free from anywhere in the U.S.:

1-800-253-1301

and talk with one of our trained consultants. The consultant can instruct you in how to obtain satisfactory operation from your appliance or, if service is necessary, recommend a qualified service company in your area.

3. If you need service*...



Whirlpool has a nationwide network of franchised TECH-CARE® Service Companies. TECH-CARE service

technicians are trained to fulfill the product warranty and provide after-warranty service, anywhere in the United States. To locate TECH-CARE service in your area. Call our COOL-LINE service assistance telephone number (see Step 2) or look in your telephone directory Yellow Pages under

APPLIANCES - HOUSEHOLD -
MAJOR - SERVICE & REPAIR

ELECTRICAL APPLIANCES -
MAJOR - REPAIRING & PARTS

OR

WASHING MACHINES, DRYERS
& IRONERS - SERVICING

WHIRLPOOL APPLIANCES
FRANCHISED TECH-CARE SERVICE

SERVICE COMPANIES
XYZ SERVICE CO.
123 MAPLE 999-9999

4. If you have a problem*...

Call our COOL-LINE service assistance telephone number (see Step 2) and talk with one of our consultants, or if you prefer, write to:

Mr. Donald Skinner
Director of Customer Relations
Whirlpool Corporation
2000 M-63
Benton Harbor, MI 49022

Please include a daytime phone number in your correspondence.

5. If you need FSP® replacement parts*...

FSP is a registered trademark of Whirlpool Corporation for quality parts. Look for this symbol of quality whenever you need a replacement part for your Whirlpool appliance. FSP replacement parts will fit right and work right, because they are made to the same exacting specifications used to build every new Whirlpool appliance.

To locate FSP replacement parts in your area, refer to Step 3 above or call the Whirlpool COOL-LINE service assistance number in Step 2.

*If you must call or write, please provide: **model number, serial number, date of purchase, and a complete description of the problem.** This information is needed in order to better respond to your request for assistance.

Coolerator® Dehumidifier WARRANTY

DH001

LENGTH OF WARRANTY	WHIRLPOOL WILL PAY FOR
FULL ONE-YEAR WARRANTY From Date of Purchase.	FSP® replacement parts and repair labor to correct defects in materials or workmanship.
FULL FIVE-YEAR WARRANTY From Date of Purchase.	FSP replacement parts and repair labor to correct defects in materials or workmanship in the sealed refrigeration system. These parts are: 1. Compressor 4. Drier-Strainer 2. Evaporator 5. Connecting tubing 3. Condenser

WHIRLPOOL WILL NOT PAY FOR

- A.** Service calls to:
1. Correct the installation of the dehumidifier.
 2. Instruct you how to use the dehumidifier.
 3. Replace house fuses or correct house wiring.
 4. Clean or replace air filter.
- B.** Pick up and delivery. This product is designed to be repaired in the home.
- C.** Damage to the dehumidifier caused by accident, misuse, fire, flood, acts of God or use of products not approved by Whirlpool.
- D.** The removal and reinstallation of the dehumidifier if it is installed in an overhead or other inaccessible location or not installed in accordance with published installation instructions.

Service under the full warranties must be provided by a franchised TECH-CARE® service company.

WHIRLPOOL CORPORATION SHALL NOT BE LIABLE FOR INCIDENTAL OR CONSEQUENTIAL DAMAGES. Some states do not allow the exclusion or limitation of incidental or consequential damages so this limitation or exclusion may not apply to you. This warranty gives you specific legal rights, and you may also have other rights which vary from state to state.

Outside the United States, a different warranty may apply. For details, please contact your franchised Whirlpool distributor or military exchange.



COOLERATOR®
DEHUMIDIFIERS

Manufactured by Whirlpool Corporation.

Part No. 1156920 Rev. A
©1989 Whirlpool Corporation

Printed in U.S.A.