

This Owner's Manual is provided and hosted by [Appliance Factory Parts](#).



# WHIRLPOOL AD0202XM2 Owner's Manual

[Shop genuine replacement parts for WHIRLPOOL  
AD0202XM2](#)



[Find Your WHIRLPOOL Dehumidifier Parts - Select From 309 Models](#)

----- Manual continues below -----

# use & care guide

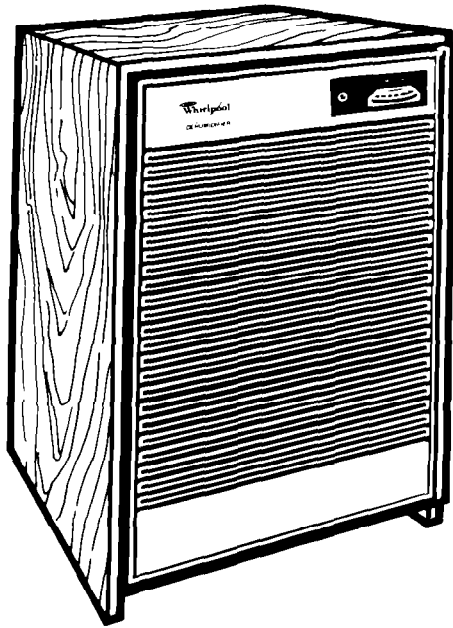

## DEHUMIDIFIERS

ers, Freezers, Refrigerator-Freezers, Ice Makers, Dishwashers, Built-In Ovens and Surface Units, Ranges, Microwave Ovens, Trash Compactors, Room Air Conditioners, Dehumidi

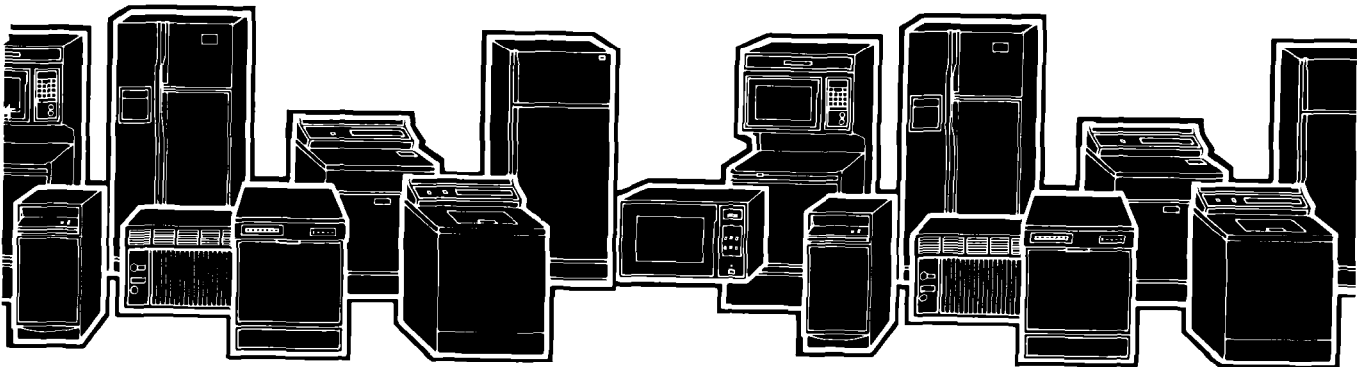

# Please read this Use and Care Guide before you do anything else...

This booklet tells you how to install your dehumidifier, use it and clean it. Treat your new dehumidifier with care. Use it only to do what home dehumidifiers are designed to do.

## Contents

	Page		Page
<b>Parts and Features</b> .....	2	Water Disposal .....	7
<b>Before You Plug It In</b> .....	3	<b>Caring for Your Dehumidifier</b> .....	7
Install Properly .....	3	Dehumidifier De-Icer Control .....	9
Electrical Requirements .....	4	<b>If You Need Service or Assistance</b> .....	9
<b>Using Your Dehumidifier</b> .....	5	1. Before Calling for Assistance .....	9
12 Pint Capacity Model .....	5	2. If You Need Assistance .....	9
All Other Models .....	5	3. If You Need Service .....	10
Setting the Water Level Control .....	6	4. If You Have a Problem .....	10

©1985 Whirlpool Corporation

## Parts and features

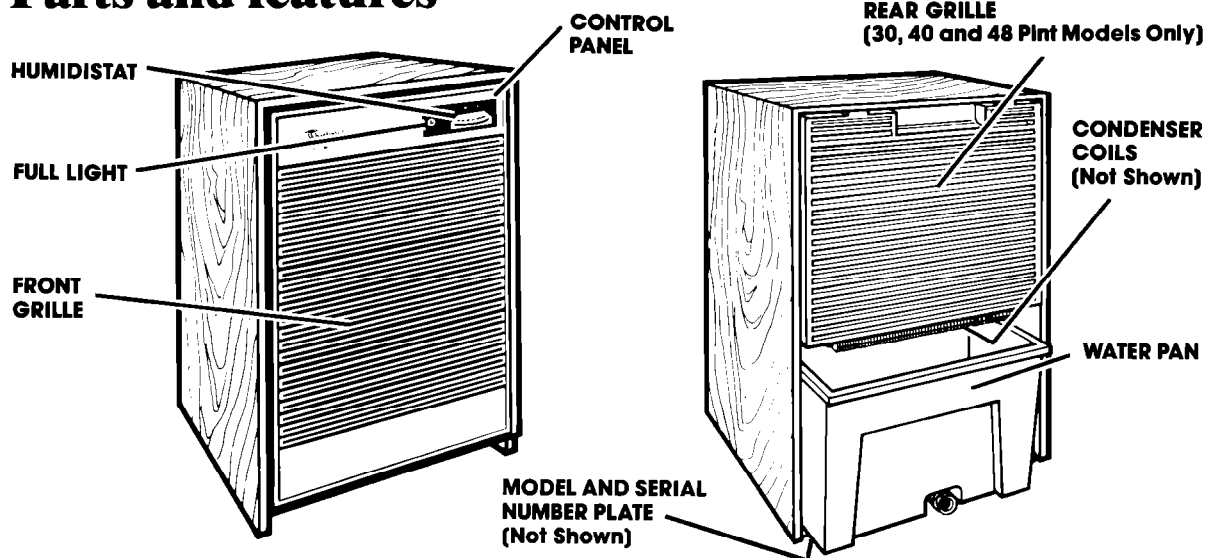

## Copy your Model and Serial Numbers here...

If you need service or call with a question, have this information ready:

1. **Complete** Model and Serial Numbers (from the plate under the water pan on the base of the unit).
2. Purchase date from the sales slip.

Copy this information in these spaces. Keep this book, your warranty and sales slip together in a handy place.

Model Number \_\_\_\_\_

Serial Number \_\_\_\_\_

Purchase Date \_\_\_\_\_

Service Company Phone Number \_\_\_\_\_

# Before you use your dehumidifier

**It is your personal responsibility and obligation to make sure your dehumidifier:**

- Has been properly installed on a floor that is reasonably level.
- Is the right size for the area you want to dehumidify.
- Is connected to the right kind of outlet, with the proper electrical supply and grounding. (Refer to your "Electrical Requirements.")
- Is used only for jobs expected of home dehumidifiers.
- Is not used by children or anyone not able to operate it properly.
- Is properly maintained.
- Is used in an area where the room temperature will not fall below 65°F (18.3°C). [48 Pint Model will operate in temperatures down to 50°F (10°C).]
- Do not remove tech sheet which is inside the cabinet. Your service technician needs this information.

## Install Properly...

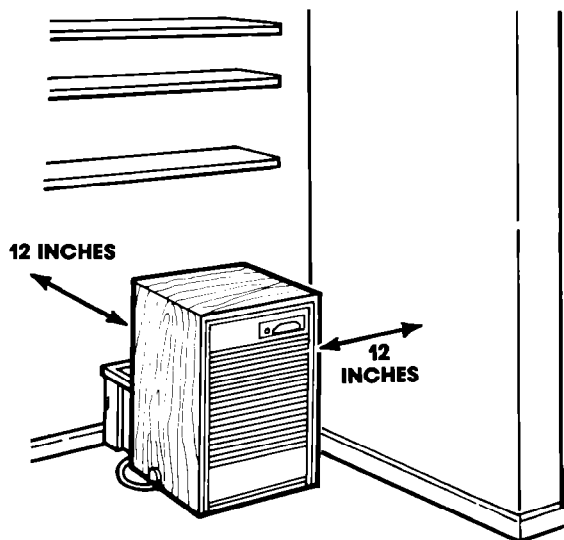

1. On most models, two rollers let you easily move the dehumidifier. Remove the water pan. Tilt unit forward and roll to another position. If your model does not have rollers, pick up the unit to move it to another position.
2. **Allow at least 12 inches (30.5 cm) of space around the unit for good air circulation.**
3. Keep all outside doors, windows and other openings closed when dehumidifier is operating. Humid outdoor air will add to the dehumidifier's operating load.
4. Water pan must be properly positioned, on the hangers inside the cabinet, when dehumidifier is operating.

## Electrical Requirements

**OBSERVE ALL GOVERNING CODES AND ORDINANCES.**  
**Electrical ground is required on this appliance.**

A 115 volt, 60 Hz., AC only, 15 or 20 ampere fused electrical supply is required. (Time delay fuse or circuit breaker is recommended.) It is recommended that a separate circuit serving only this appliance be provided. **Do not use an extension cord.**

**DO NOT UNDER ANY CIRCUMSTANCES, REMOVE THE POWER SUPPLY CORD GROUND PRONG.**

### RECOMMENDED GROUNDING METHOD

For your personal safety, this appliance must be grounded. This appliance is equipped with a power supply cord having a 3-prong grounding plug. To minimize possible shock hazard, the cord must be plugged into a mating 3-prong grounding type wall receptacle, grounded in accordance with the National Electrical Code and local codes and ordinances. If a mating wall receptacle is not available, it is the personal responsibility and obligation of the customer to have a properly grounded 3-prong wall receptacle installed by a qualified electrician.

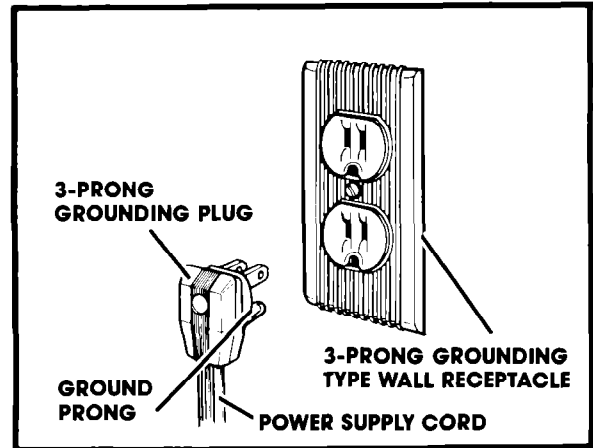

### ALTERNATE GROUNDING METHOD

If changing and properly grounding the wall receptacle is impossible and where local codes permit (consult your electrical inspector), a temporary adaptor may be plugged into the existing 2-prong wall receptacle to mate with the 3-prong power supply cord. **THIS HOWEVER, IS NOT RECOMMENDED.**

If this is done, you must connect the grounding eyelet on the adaptor to the wall receptacle cover plate screw and from this same screw, you must connect a separate copper ground wire (#14 minimum) to a grounded cold water pipe\* **Do not ground to a gas supply pipe. Do not connect to electrical supply until appliance is permanently grounded.**

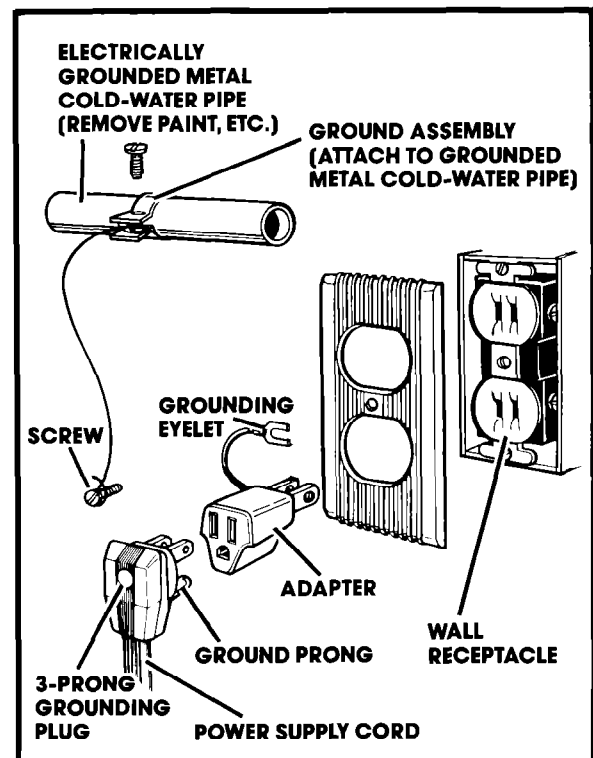

\*Cold water pipe must have metal continuity to electrical ground and not be interrupted by plastic, rubber or other electrically insulating connectors (including water meter or pump) without adding a jumper wire at these connections.

## Using your dehumidifier

You will use your dehumidifier more during months when you're not heating your home. But your dehumidifier can help prevent excessive moisture and keep you comfortable all year in any area of your home.

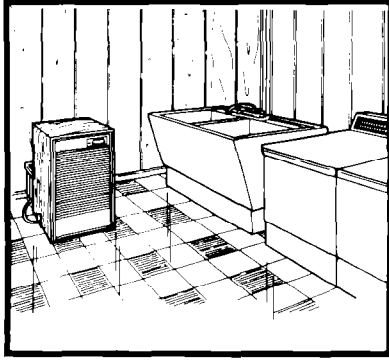

Use in a basement to help prevent moisture damage.

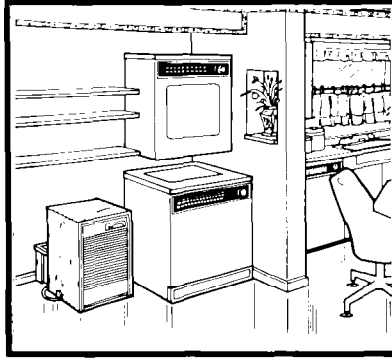

Use in cooking, laundry, bathing, and dishwashing areas which have excess moisture.

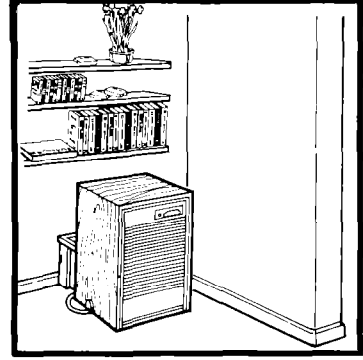

Use to prevent moisture damage anywhere books or valuables are stored.

**NOTE:** Do not operate any model in temperatures below 65°F (18.3°C), except the 48 Pint Model which will operate down to 50°F (10°C).

### 12 Pint Capacity Model

Just plug it in to start. To stop, pull plug. This model does not have an ON/OFF switch or humidistat.



**CAUTION:** The 12 pint (5.6 L) capacity unit does not have a water level control. The water level in the pan needs to be checked and emptied when full, unless another disposal method is being used. See page 7.

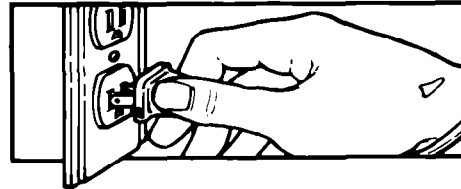

### All Other Models

All models except the 12 pint (5.6 L) capacity have a **FULL Light**. The light glows when the pan is full of water to indicate that it needs emptying.



FULL LIGHT    HUMIDISTAT

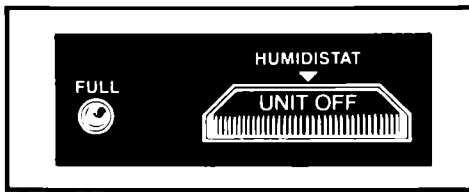

1. Turn humidistat to UNIT OFF, then plug in the dehumidifier.

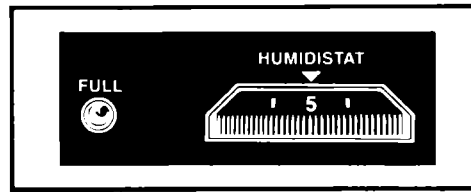

2. Your dehumidifier has an **automatic humidistat**. Turn humidistat control left towards DRYEST for normal operation. Set at number 5 or 6 to start. Adjust later, if necessary.

When humidity in the room increases, the dehumidifier automatically starts. When the humidity decreases to the selected level, the dehumidifier automatically stops.

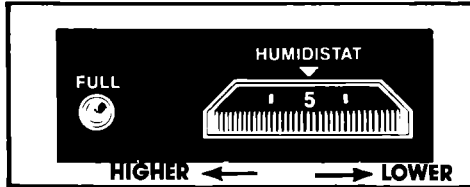

3. If you need more dehumidification, turn control to a higher number. Unit will run continuously at DRYEST setting. If you need less, set on a lower number.

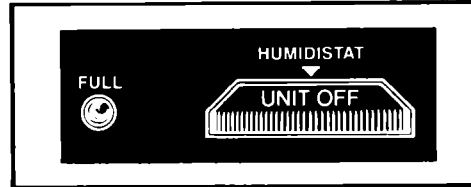

4. Stop the unit manually by turning the control to UNIT OFF.

## Setting the Water Level Control

All models except the 12 pint (5.6 L) capacity model have an adjustable water level control. The water level control can be set in two positions to automatically turn off the unit when the pan is full. This prevents the danger of overflow.

Pan must be in proper position for water level control switch to work.

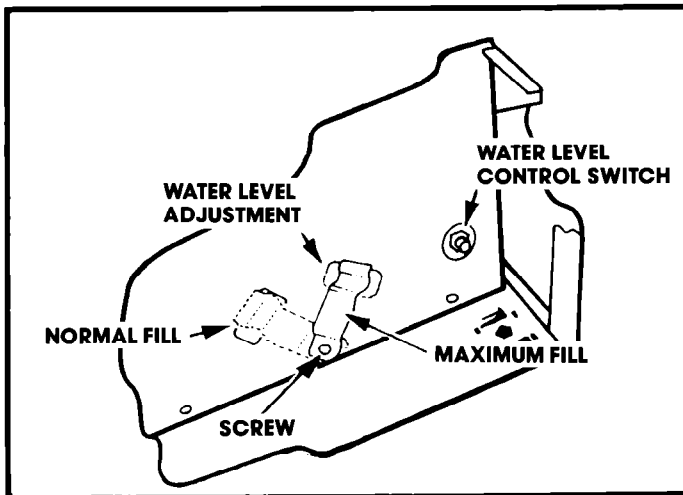

### NORMAL FILL –

Water level adjustment set on the left side indentation. The water pan and water will weigh approximately 16 lbs. (7.2 kg).

### MAXIMUM FILL –

Move the water level control to the raised area on the right side. The water pan and water will weigh approximately 24 lbs. (10.8 kg).

The water level control switch will automatically turn off the dehumidifier at the fill level you selected. You may need to loosen the screw to move the water level adjustment. Retighten screw when adjusted.

## Water Disposal

All models have a 24 pint (11.3 L) capacity water pan.

There are three methods of disposing of water:



**WARNING: Do not use the water that collects in the water pan for drinking purposes. It is not sanitary and could cause illness.**

### 1. Empty pan manually.

When pan is full, remove it, empty it and put it back in place. Be sure pan is properly placed so the water level control switch will work to automatically shut off the unit.

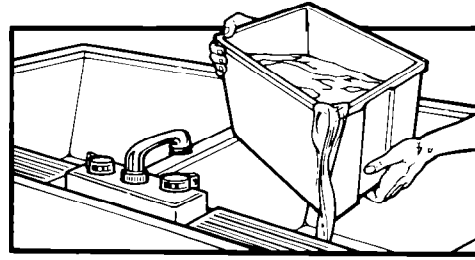

### 2. Place unit directly over drain.

Pan has a threaded hose connection which can be left open. Cut out opening with a knife or  $\frac{3}{4}$ " wood drill.

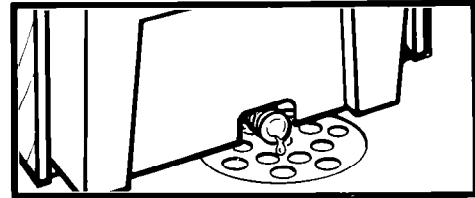

### 3. Attach garden hose to the threaded hose connection to carry water to drain.

- Pan has a threaded hose connection which can be left open. Cut out opening with a knife or  $\frac{3}{4}$ " wood drill.
- Attach garden hose. Be sure hose does not kink or bend. It should lie flat from unit to drain.

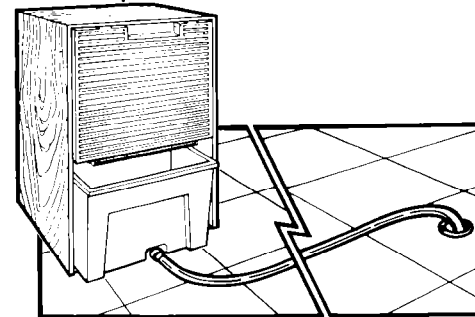

## Caring for your dehumidifier

Your dehumidifier is designed to serve you year-round. It needs practically no attention. However, you should check your dehumidifier and inspect the coils annually. Follow these instructions carefully.

You may call a service company to perform this annual checkup or you can do it yourself. Cost of annual inspection is the owner's responsibility.



**WARNING: Disconnect power supply cord from receptacle before performing any maintenance. Failure to follow these instructions could cause personal injury.**

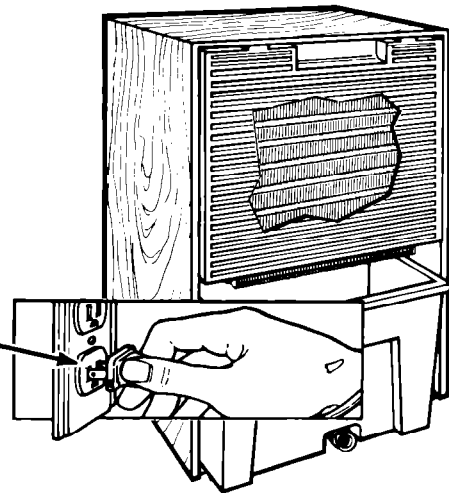

**1.** To remove outer cabinet:

- a. Disconnect power cord.
- b. Take off the front plastic grille. Remove the two screws at the bottom. Drop grille down and take out.

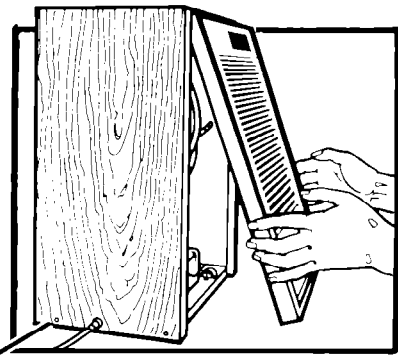
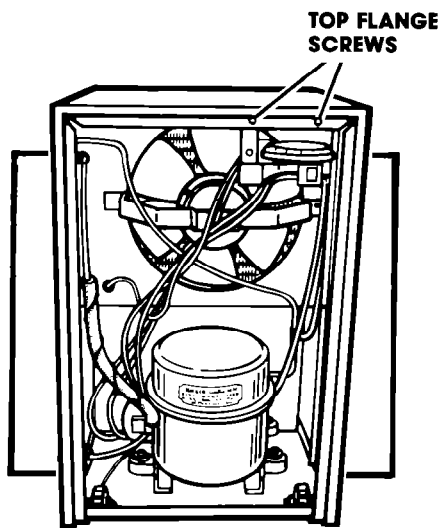

SOCKET HEAD SCREWS (side of cabinet)

- c. Remove the cabinet screws on each side and top flange screws (see illustration). On 30, 40 and 48 pt. models, also remove rear grille. Pull out at bottom and drop grille down.
- d. Lift cabinet from unit.

**2.** Coils should be inspected annually. Brush clean, if necessary, with warm water and mild detergent. Rinse and dry. **Be sure power supply cord is disconnected.**

 **WARNING: Be careful when cleaning the condenser coils. Fins are sharp and could cause personal injury.**

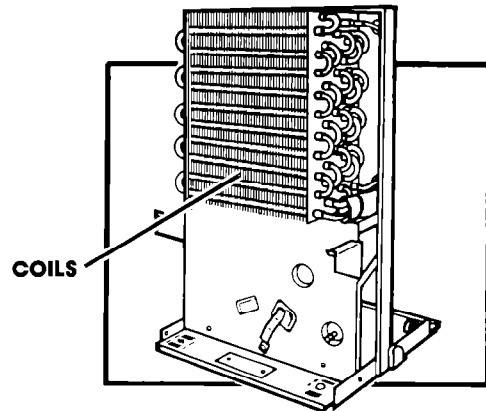

**3.** The compressor is sealed and needs no oiling. However, the fan motor should be checked annually and oiled.

**4.** To oil fan motor, place a few drops of a good grade oil in both oil holes located on the fan motor. Oil capsules can be ordered (Part No. 10943) from your dealer.

OIL FAN MOTOR (Back Oil Hole Not Shown)

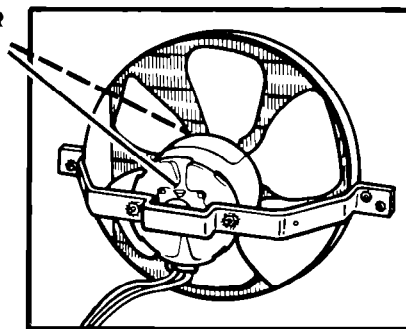

**5.** Wash plastic parts with a soft cloth, warm water and mild detergent. Rinse and dry with a soft cloth.

**6.** Replace cabinet grille(s). Reconnect power supply cord.

## Dehumidifier DE-ICER control

The 48 Pint Model dehumidifier has a DE-ICER control built into it. This feature allows you to operate the unit in room temperatures below 65°F (18.3°C). Without this de-icer control, the unit's evaporator coil would form frost that could prevent proper operation.

The DE-ICER control senses frost build-up on the evaporator coils. When frost build-up is sensed it automatically shuts off the compressor, but allows the fan to continue running. The fan draws air across the coil which melts the frost. When the coil is defrosted, the DE-ICER control automatically restarts the compressor and resumes dehumidifying.

This unit will not operate properly in room temperatures below 50°F (10°C).

## If you need service or assistance, we suggest you follow these four steps:



### 1. Before calling for assistance...

Performance problems often result from little things you can find and fix yourself without tools of any kind.

#### If unit won't operate:

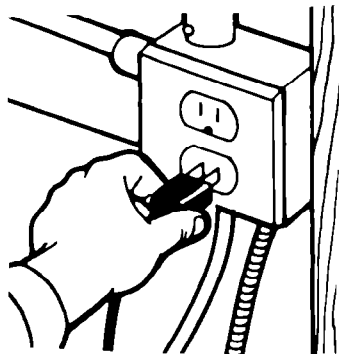

- Is the dehumidifier correctly plugged into a live circuit with the proper voltage?
- Is the humidistat set to a position other than UNIT OFF? Try a dryer setting.

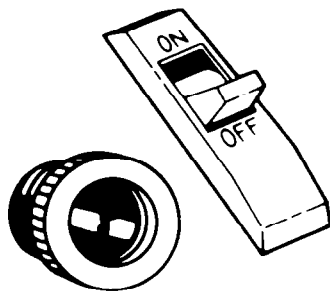

- Have you checked the main fuse or circuit breaker box?
- If a 48 pint model, is the temperature below 50°F (10°C)? The fan should run, but the unit will not dehumidify.

#### If unit blows fuses or trips circuit breakers:

- Are correct time-delay fuses being used in the main fuse box?

- Is an extension cord being used? **Do not use an extension cord.**
- Are the coils iced or clogged with lint?

#### If unit ices up:

- Is humidity too low?
- Is room temperature below 65°F (18.3°C)? Coil will become iced over at low temperatures, except the 48 pint model which will operate down to 50°F (10°C).

#### If water collects on the floor:

- Is unit reasonably level?
- Is hose or drain clogged or kinked?
- Is the water pan overflowing? Pan must be properly positioned.

#### Special dehumidifier needs:

- Annual inspection: Clean coils, inspect drain and hoses, oil the fan motor.
- Moving: When moving, keep the unit in an upright position.

**Remember...**Please include the model and serial number of your appliance when requesting service. Also, retain your sales slip and warranty to verify your warranty status. Learn the benefits of using TECH-CARE® service for maintaining the quality originally built into your WHIRLPOOL appliance.

### 2. If you need assistance\*...

**Call the Whirlpool COOL-LINE® service assistance telephone number. Dial free from:**

**Continental U.S. .... (800) 253-1301**

**Michigan ..... (800) 632-2243**

**Alaska & Hawaii ..... (800) 253-1121**

and talk with one of our trained Consultants. The Consultant can instruct you on how to obtain satisfactory operation from your appliance or, if service is necessary, recommend a qualified service company in your area.

### 3. If you need service\*...



Whirlpool has a nationwide network of franchised TECH-CARE® Service Companies. TECH-CARE service technicians are trained to fulfill the product warranty and provide after-warranty service, any-

where in the United States. To locate TECH-CARE service in your area, call our COOL-LINE service assistance telephone number (see Step 2) or look in your telephone directory Yellow Pages under:

- |  |           |   |
|--|-----------|---|
| <b>APPLIANCES-HOUSEHOLD-<br/>MAJOR-SERVICE &amp; REPAIR</b>  | <b>OR</b> | <b>ELECTRICAL APPLIANCES-<br/>MAJOR-REPAIRING &amp; PARTS</b> |
| <b>WHIRLPOOL APPLIANCES<br/>FRANCHISED TECH-CARE SERVICE</b> |           | <b>WHIRLPOOL APPLIANCES<br/>FRANCHISED TECH-CARE SERVICE</b>  |
| <b>SERVICE COMPANIES</b>                                     |           | <b>SERVICE COMPANIES</b>                                      |
| XYZ SERVICE CO<br>123 Maple ..... 999-9999                   |           | XYZ SERVICE CO<br>123 Maple ..... 999-9999                    |
| <b>OR</b>  |           |   |
| <b>WASHING MACHINES, DRYERS<br/>&amp; IRONERS-SERVICING</b>  |           |   |
| <b>WHIRLPOOL APPLIANCES<br/>FRANCHISED TECH-CARE SERVICE</b> |           |   |
| <b>SERVICE COMPANIES</b>                                     |           |   |
| XYZ SERVICE CO<br>123 Maple ..... 999-9999                   |           |   |

### 4. If you have a problem\*...

Call our COOL-LINE service assistance telephone number (see Step 2) and talk with one of our Consultants, or if you prefer, write to:

Mr. Robert Stanley  
Division Vice President  
Whirlpool Corporation  
2000 US-33, North  
Benton Harbor, MI 49022

\*If you must call or write, please provide: model number, serial number, date of purchase, and a complete description of the problem. This information is needed in order to better respond to your request for assistance.



FSP is a registered trademark of Whirlpool Corporation for quality parts. Look for this symbol of quality whenever you need a replacement part for your Whirlpool appliance. FSP replacement parts

will fit right and work right, because they are made to the same exacting specifications used to build every new Whirlpool appliance.





Making your world a little easier.

Part No. 952622  
©1985 Whirlpool Corporation

Printed in U.S.A.

---

Ice Makers, Dishwashers, Built-In Ovens and Surface Units, Ranges, Microwave Ovens, Trash Compactors, Room Air Conditioners, Dehumidifiers, Automatic Washers, Clothes Dr

