

This Owner's Manual is provided and hosted by [Appliance Factory Parts](#).



WHIRLPOOL AD0302XA2 Owner's Manual

[Shop genuine replacement parts for WHIRLPOOL
AD0302XA2](#)



[Find Your WHIRLPOOL Dehumidifier Parts - Select From 309 Models](#)

----- Manual continues below -----



Use And Care

G U I D E



DEHUMIDIFIERS

MODELS ADO25 ADO30
ADO40 ADO50

2/94

A Note To You

Thank you for buying a Whirlpool® appliance.

You purchased a quality, *world-class* home appliance. Years of engineering experience went into its manufacturing. To ensure that you enjoy many years of trouble-free operation, we developed this Use and Care Guide. It is full of valuable information on how to operate and maintain your appliance properly and safely. Please read it carefully. Also, please complete and mail the Ownership Registration Card provided with your appliance. This will help us notify you about any new information on your appliance.

Your safety is important to us.

This guide contains safety symbols and statements. Please pay special attention to these symbols and follow any instructions given. Here is a brief explanation of the use of each symbol.

⚠ WARNING

This symbol will help alert you to such dangers as personal injury, burns, fire and electrical shock.

⚠ CAUTION

This symbol will help you avoid actions which could cause product damage (scratches, dents, etc.) and damage to your personal property.

Our Consumer Assistance Center number, 1-800-253-1301, is toll-free, 24 hours a day.

If you ever have a question concerning your appliance's operation, or if you need service, first see "If You Need Assistance Or Service" on page 13. If you need further help, feel free to call our Consumer Assistance Center. When calling, you will need to know your appliance's complete model number and serial number. You can find this information on the model and serial number label (see diagram on page 4). For your convenience, we have included a handy place below for you to record these numbers, the purchase date from the sales slip and your dealer's name and telephone number. Keep this book and the sales slip together in a safe place for future reference.

Model Number _____

Dealer Name _____

Serial Number _____

Dealer Phone _____

Purchase Date _____

Important Safety Instructions

⚠ WARNING

To reduce the risk of fire, electrical shock or personal injury when using your dehumidifier, follow these basic precautions:

- Read all instructions before using your dehumidifier.
- Complete the installation and electrical requirements as described in "Before Using Your Dehumidifier" on pages 5 and 6.
- Never allow children to operate or play with the dehumidifier.
- Never clean dehumidifier parts with flammable fluids. The fumes can create a fire hazard or explosion.

• FOR YOUR SAFETY •

DO NOT STORE OR USE GASOLINE OR OTHER FLAMMABLE VAPORS AND LIQUIDS IN THE VICINITY OF THIS OR ANY OTHER APPLIANCE. THE FUMES CAN CREATE A FIRE HAZARD OR EXPLOSION.

– SAVE THESE INSTRUCTIONS –

Help us help you

Please:

- Install the dehumidifier properly on a floor, table or shelf that is level and strong enough to support unit with a full pan of water. Unit can weigh between 50 lbs. (22.5 kg) and 75 lbs. (33.75 kg), depending on the amount of water collected in the pan.
- Make sure the dehumidifier is the correct size for the area you want to dehumidify.
- Connect the dehumidifier to the proper kind of outlet, with the correct electrical supply and grounding. (See "Meeting electrical requirements" on page 6.)
- Use the dehumidifier only for jobs as described in this manual.
- Make sure the dehumidifier is not used by children or anyone unable to operate it properly.
- Maintain your dehumidifier properly.

DO NOT REMOVE TECH SHEET from inside cabinet. Your service technician will need this information.

PARTS AND FEATURES

Parts And Features

This section contains captioned illustrations of your appliance. Use them to become familiar with where all parts and features are located and what they look like.

Front view

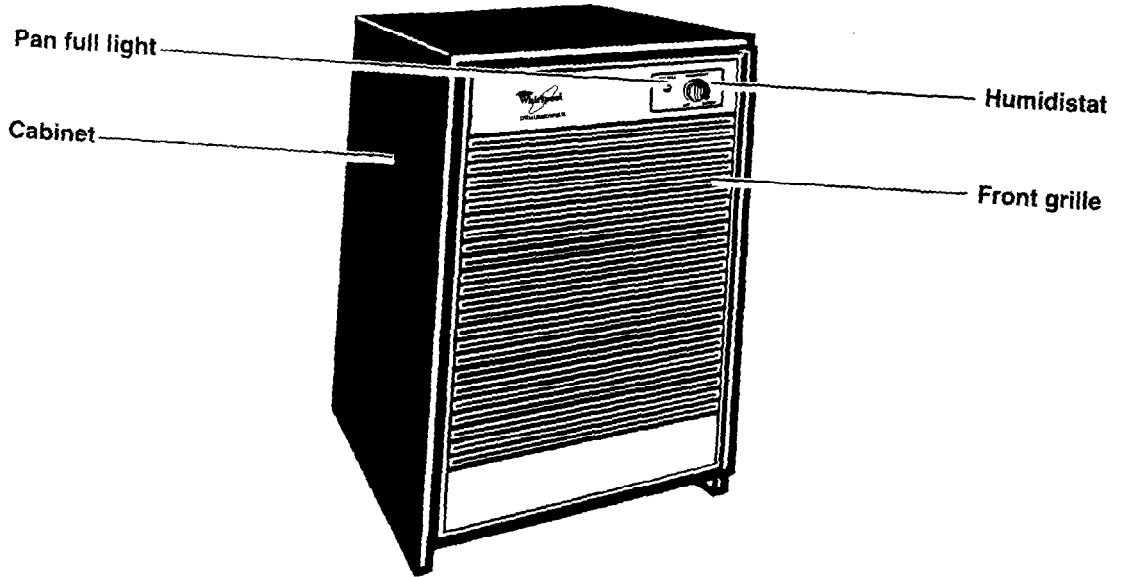

Rear view

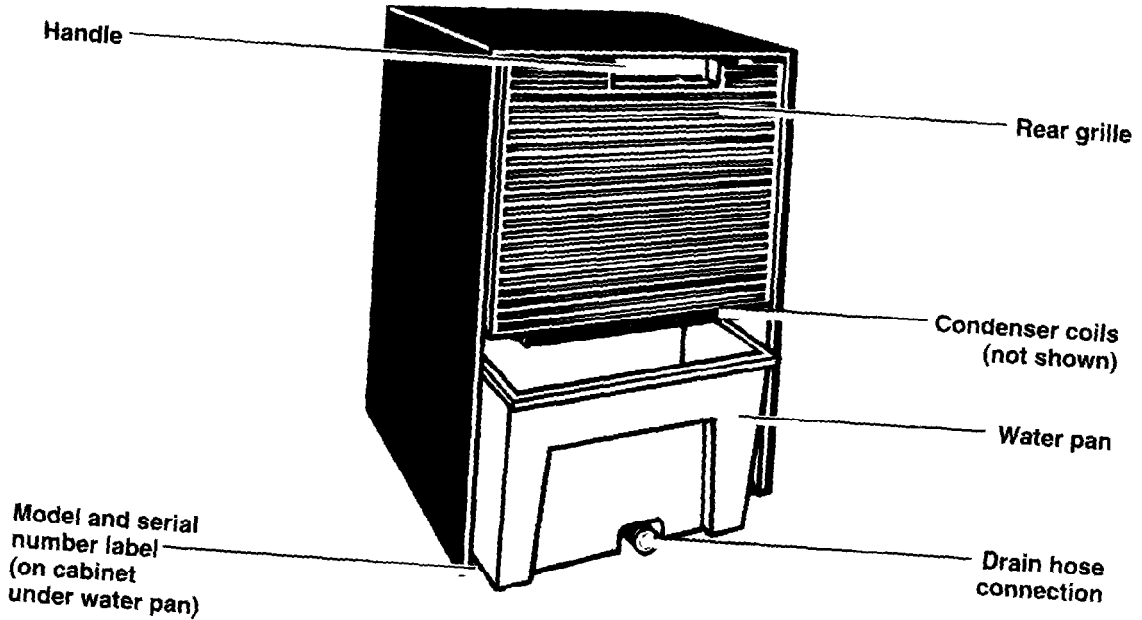

Before Using Your Dehumidifier

In This Section

Installing it properly5

Page

Meeting electrical requirements6

Page

Proper installation and electrical grounding is important for obtaining the best possible results from your dehumidifier. This section tells you how to install your unit and how to connect it to the proper electrical supply.

Installing it properly

⚠ WARNING**Personal Injury Hazard**

Because your dehumidifier weighs between 50 lbs. (22.5 kg) and 75 lbs. (33.75 kg), depending on the amount of water collected in the pan, it is recommended that you use proper lifting techniques when lifting or moving your unit.

Failure to do so could result in personal injury.

1. Allow at least 12 inches (30.5 cm) of space on all sides of the unit for good air circulation.
2. Install the unit on a floor, table or shelf. When installing the unit on a table or shelf, be sure it is strong enough to support the unit with a full pan of water. A table or shelf may be a better position from which to handle the water pan. Do not sit or stand on this product. The height of a table or shelf may help prevent icing of coils due to colder air near the floor (such as can be found in a basement).
3. Keep all outside doors, windows and other openings closed when dehumidifier is operating. Humid outdoor air will add to the dehumidifier's operating load.

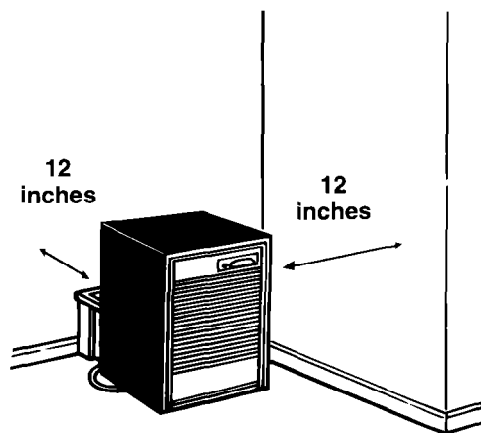

4. The water pan must be properly positioned, on the hangers inside the cabinet, when dehumidifier is operating in order for the automatic shut-off to operate correctly.
5. Two rollers let you move the dehumidifier easily. Remove the water pan, tilt the unit forward and roll it to another position.

Meeting electrical requirements

OBSERVE ALL GOVERNING CODES AND ORDINANCES.

Electrical ground is required on this appliance.

A 115 volt, 60 Hz., AC only, 15 ampere fused electrical supply is recommended. (Time delay fuse or circuit breaker is recommended.) It is recommended that a separate circuit serving only this appliance be provided. **Do not use an extension cord.**

DO NOT, UNDER ANY CIRCUMSTANCES, REMOVE THE POWER SUPPLY CORD GROUND PRONG.

Recommended grounding method

For your personal safety, this appliance must be grounded. This appliance has a power supply cord with a 3-prong grounding plug. To minimize possible shock hazard, the cord must be plugged into a mating grounding type wall receptacle, grounded in accordance with the National Electrical Code (ANSI/NFPA 70, latest edition) and all local codes and ordinances. If a mating wall receptacle is not available, it is the responsibility of the customer to have a properly grounded, 3-prong wall receptacle installed by a qualified electrician.



Using Your Dehumidifier

In This Section	Page		Page
Choosing the proper location for your dehumidifier	7	Adjusting the water level control lever	9
Operating your dehumidifier	8	Disposing of collected water	10

When operated properly, your dehumidifier will prevent excessive moisture and keep you comfortable all year round. This section tells you how to obtain the best possible results from your dehumidifier.

Choosing the proper location for your dehumidifier

You can use your dehumidifier in any area of your home. Below are a few suggestions for placement and uses.

- Use in a basement to help prevent moisture damage.

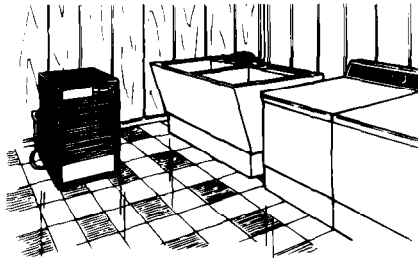

- Use in cooking, laundry, bathing and dishwashing areas which have excess moisture.

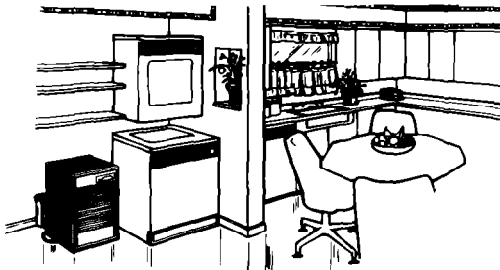

- Use to prevent moisture damage anywhere books or valuables are stored.

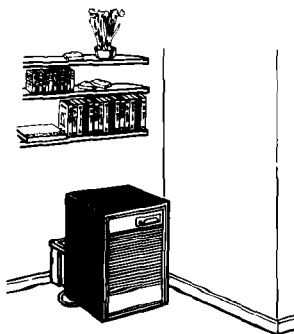

Operating your dehumidifier

Control panel

These units have a control panel containing two controls—the PAN FULL Light and the Humidistat.

PAN FULL Light—This light glows when the water pan is full and needs to be emptied.

Humidistat—This controls the amount of moisture in the room. When the humidity in the room rises above the setting, the unit automatically starts. When the humidity drops below the setting, the unit automatically stops. The unit will run constantly when the control is set to DRYEST.

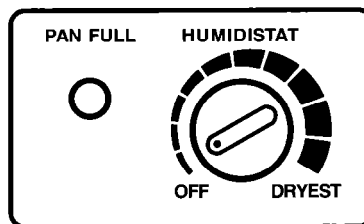

Unit operation

1. Turn the Humidistat to OFF. Plug the power supply cord into an electrical outlet. Be sure to use the proper grounding method. (See page 6.)

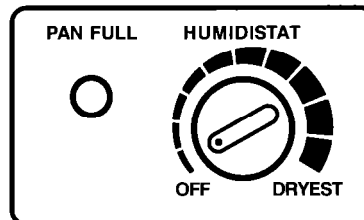

2. Turn the Humidistat toward DRYEST for normal operation.

The Humidistat can be set anywhere between OFF and DRYEST. If you need more dehumidification, turn the Humidistat toward DRYEST. If you need less dehumidification, turn the Humidistat toward OFF.

3. Turn the Humidistat to OFF to stop the unit manually.

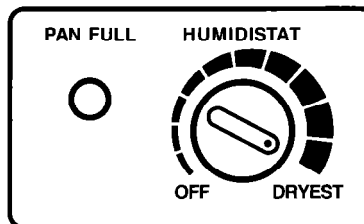

De-icer control**CAUTION****Product Damage Hazard**

Do not operate dehumidifier at temperatures below 65°F (18.3°C).

Failure to follow the above precaution could result in the coils icing over and the unit not operating properly.

Your Whirlpool dehumidifier is equipped with a feature to help you get the most comfort from your new appliance by permitting it to operate down to 65°F (18.3°C). If your dehumidifier runs when room temperature and humidity conditions are low, frost can form on its evaporator coil. This interferes with proper operation.

The De-icer Control senses frost build-up on the evaporator coil and automatically shuts off the compressor. The fan continues to run, drawing air across the coil and melting the frost. When the coil is defrosted, the compressor is automatically restarted, and dehumidifying is resumed.

Adjusting the water level control lever

The Water Level Adjustment can be set in two positions to turn off the unit automatically when the pan is full. This prevents the danger of overflow.

Pan must be in proper position for Water Level Control Switch to work. The Water Level Control Switch will automatically turn off the dehumidifier at the fill level you selected when pan is properly placed. Loosen the screw to move the Water Level Control Lever. Retighten screw when adjusted to desired setting.

NORMAL fill position

Set Water Level Control Lever to the indentation on the left side. The water pan and water will weigh approximately 16 lbs. (7.2 kg) and water pan will be ½ full.

MAXIMUM fill position

Set Water Level Control Lever to the raised area on the right side. The water pan and water will weigh approximately 24 lbs. (10.8 kg) and water pan will be ¾ full.

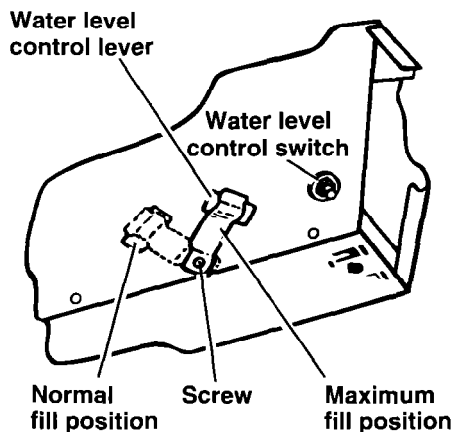

Disposing of collected water

⚠ WARNING

Personal Injury Hazard

Do not use the water that collects in the water pan for drinking purposes. It is not sanitary.

Failure to follow the above precaution could result in personal injury or illness.

There are three methods of disposing of water.

1. Empty pan manually.

When pan is full, remove it, empty it into a large sink or tub and replace it properly.

NOTE: Water pan **must** be positioned properly for the Water Level Control Switch to operate properly and turn unit off when pan is full.

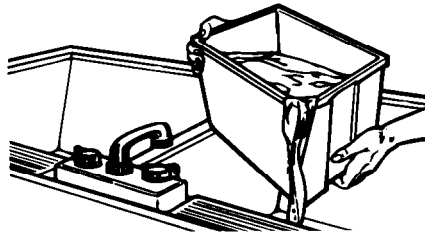

2. Place unit directly over drain.

Pan has a threaded hose connection which can be left open. Cut out opening with a knife or $\frac{3}{4}$ inch (19 mm) wood drill. Once opened, hose connection will continually drain water from the pan. Be sure to keep unit directly over a drain.

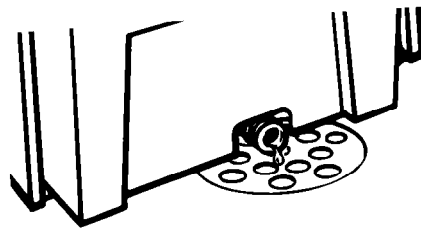

3. Attach garden hose to the threaded hose connection to carry water to drain.

- Pan has a threaded hose connection which can be left open. Cut out opening with a knife or $\frac{3}{4}$ inch (19 mm) wood drill.
- Attach garden hose. Be sure hose does not kink or bend. It should lie flat from unit to drain.
- Once hose connection is opened, pan will continually drain through the hose. Be sure to keep hose flat and in drain.

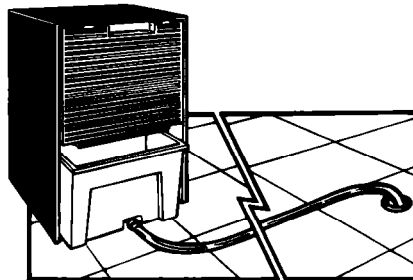

Caring For Your Dehumidifier

Your dehumidifier is designed to serve you year-round. It needs practically no attention. However, you should check your dehumidifier and inspect the coils annually.

You may call a service company to perform this annual checkup or you can do it yourself. Cost of annual inspection is the owner's responsibility.

OR

If you are familiar with electrical appliances and their functions, listed below are instructions which would allow you to do the inspection and maintenance yourself.

⚠ WARNING

Electrical Shock and Personal Injury Hazard

- Disconnect power supply cord from receptacle before performing any maintenance.
- Be careful when cleaning the coils. Fins are sharp.

Failure to follow the above precautions could result in electrical shock or personal injury.

Performing annual maintenance

1. Disconnect dehumidifier from power supply.
2. Remove the front grille.
 - Remove the two screws at bottom-front of grille.
 - Drop grille down and pull it out.
3. Remove the socket-head screws on each side of the cabinet.

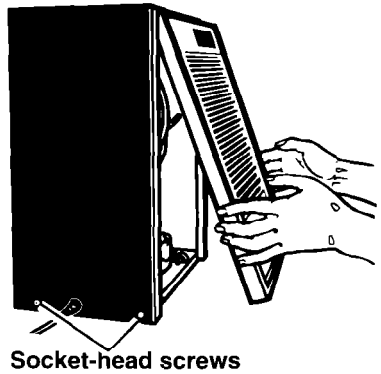

Top flange screws

4. Remove the top flange screws.

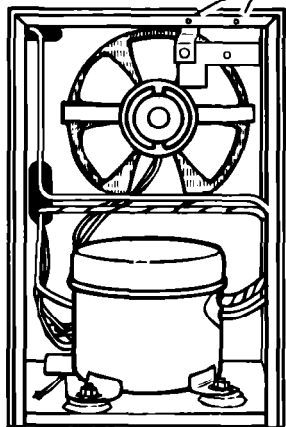

continued on next page

CARING FOR YOUR DEHUMIDIFIER

5. Remove the rear grille by pulling out at bottom and dropping grille down.
6. Lift cabinet off unit base.
7. Brush coils clean, if necessary, with warm water and a mild detergent. Rinse and dry thoroughly. **Be sure the power supply cord is disconnected from the electrical outlet.**

NOTE: The compressor is sealed and needs no oiling. The fan motor is prelubricated and does not require further oiling under **normal** operating conditions. However, if the dehumidifier is operated under severe environmental conditions (dust, dirt, high temperatures) the fan motor should be oiled annually. Follow the instructions in Step 8.



8. Oil the fan motor through the tubes provided. An easy-to-use capsule of especially recommended oil (Part No. 10943) is available from your nearest authorized Whirlpool® service company, or use SAE #20 non-detergent oil.

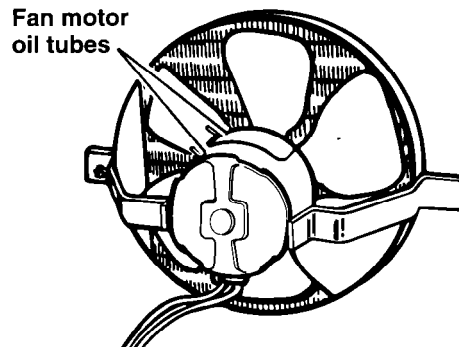

9. Wash all plastic parts with a soft cloth, warm water and a mild detergent. Rinse and dry them with a soft cloth.
10. Replace cabinet and grille(s).
11. Reconnect dehumidifier to power supply.

If You Need Assistance Or Service

Performance problems often result from little things you can fix without tools. Please read the chart below before calling for service.

1. Before calling for service ...

Listed in this chart are the most common problems consumers run into with their appliances. Please read through this chart and see if it can solve your problem.

PROBLEM	POSSIBLE SOLUTION
Dehumidifier won't operate	Firmly plug power cord into electrical outlet. If dehumidifier still won't operate, have a qualified electrician check the circuit voltage at the fuse/circuit breaker box. Replace fuse with a time-delay fuse of the correct capacity. Reset circuitbreaker.
Dehumidifier blows household fuses or trips the circuit breaker	Replace fuse with a time-delay fuse of the correct capacity. Do not use an extension cord with this or any other appliance.
Coils ice over	Clean lint from coils (see "Caring For Your Dehumidifier" on page 12).
Water collects on the floor	Do not operate unit when humidity is low. Do not operate unit in low temperatures. See "De-icer control" on page 9. Level unit front-to-back and side-to-side. Unkink drain hose or remove clog from drain. Remove and empty water pan. Be sure to replace water pan properly and check to see that the unit is level.

2. If you need assistance* ...

Call Whirlpool Consumer Assistance Center telephone number. Dial free from anywhere in the U.S.:

1-800-253-1301

and talk with one of our trained consultants. The consultant can instruct you in how to obtain satisfactory operation from your appliance or, if service is necessary, recommend a qualified service company in your area.

If you prefer, write to:

Mr. William Clark
Consumer Assistance Representative
Whirlpool Corporation
2000 M-63
Benton Harbor, MI 49022

Please include a daytime phone number in your correspondence.

3. If you need service* ...

Whirlpool has a nationwide network of authorized Whirlpool® service companies. Whirlpool service technicians are trained to fulfill the product warranty and provide after-warranty service, anywhere in the United States. To locate the authorized Whirlpool service company in your area, call our Consumer Assistance Center telephone number (see Step 2) or look in your telephone directory Yellow Pages under:

• APPLIANCE-HOUSEHOLD-MAJOR, SERVICE & REPAIR

- See: Whirlpool Appliances or Authorized Whirlpool Service (Example: XYZ Service Co.)

• WASHING MACHINES & DRYERS, SERVICE & REPAIR

- See: Whirlpool Appliances or Authorized Whirlpool Service (Example: XYZ Service Co.)

4. If you need FSP® replacement parts* ...

FSP is a registered trademark of Whirlpool Corporation for quality parts. Look for this symbol of quality whenever you need a replacement part for your Whirlpool appliance. FSP replacement parts will fit right and work right, because they are made to the same exacting specifications used to build every new Whirlpool appliance.

To locate FSP replacement parts in your area, refer to Step 3 above or call the Whirlpool Consumer Assistance Center number in Step 2.

5. If you are not satisfied with how the problem was solved ...

- Contact the Major Appliance Consumer Action Panel (MACAP). MACAP is a group of independent consumer experts that voices consumer views at the highest levels of the major appliance industry.
- Contact MACAP only when the dealer, authorized servicer and Whirlpool have failed to resolve your problem.

Major Appliance Consumer Action Panel
20 North Wacker Drive
Chicago, IL 60606

- MACAP will in turn inform us of your action.

***When asking for help or service:**

Please provide a detailed description of the problem, your appliance's complete model and serial numbers, and the purchase date. (See page 2.) This information will help us respond properly to your request.

WHIRLPOOL®

Dehumidifier Warranty

LENGTH OF WARRANTY	WHIRLPOOL WILL PAY FOR
FULL ONE-YEAR WARRANTY From Date of Purchase	FSP® replacement parts and repair labor to correct defects in materials or workmanship.
FULL FIVE-YEAR WARRANTY From Date of Purchase	FSP replacement parts and repair labor to correct defects in materials or workmanship in the sealed refrigeration system. These parts are: 1. Compressor 4. Drier-Strainer 2. Evaporator 5. Connecting Tubing 3. Condenser
WHIRLPOOL WILL NOT PAY FOR	
A. Service calls to: 1. Correct the installation of your dehumidifier. 2. Instruct you how to use your dehumidifier. 3. Replace house fuses or correct house wiring. B. Pickup and delivery. Your dehumidifier is designed to be repaired in the home. C. Damage to your dehumidifier caused by accident, misuse, fire, flood, acts of God or use of products not approved by Whirlpool. D. Repairs to parts or systems caused by unauthorized modifications made to the appliance.	

5/93

Service under the full warranties must be provided by an authorized Whirlpool service company.

WHIRLPOOL CORPORATION SHALL NOT BE LIABLE FOR INCIDENTAL OR CONSEQUENTIAL DAMAGES. Some states do not allow the exclusion or limitation of incidental or consequential damages, so this limitation or exclusion may not apply to you. This warranty gives you specific legal rights, and you may also have other rights which vary from state to state.

Outside the United States, a different warranty may also apply. For details, please contact your authorized Whirlpool distributor or military exchange.

If you need service, first see the "Assistance or Service" section of this book. After checking "Assistance or Service," additional help can be found by calling our Consumer Assistance Center telephone number, **1-800-253-1301**, from anywhere in the U.S.



Printed on recycled paper—
10% post-consumer waste
50% recovered materials

PART NO. 1164267 Rev. A

© 1993 Whirlpool Corporation

® Registered Trademark of Whirlpool Corporation.

Printed in U.S.A.