

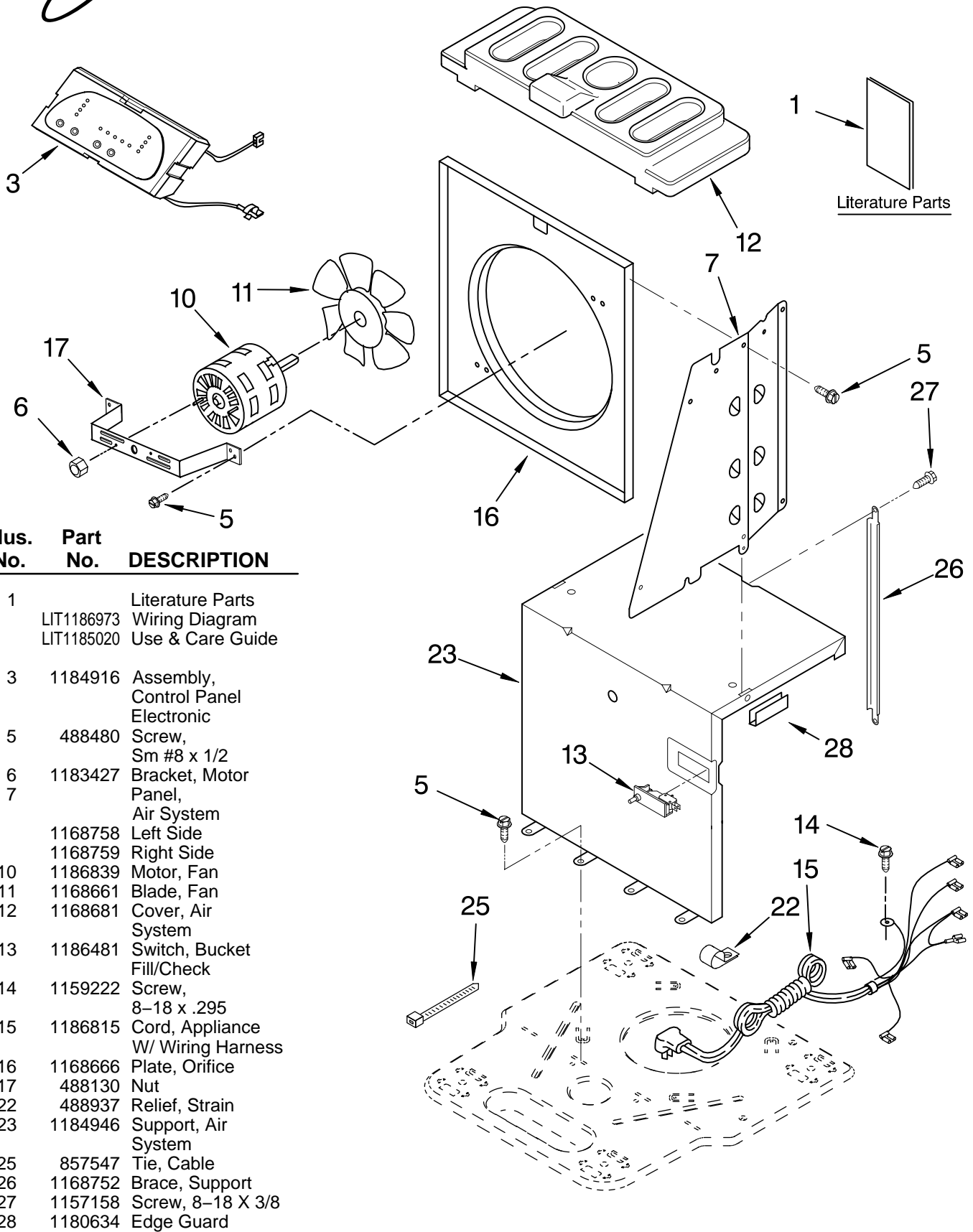

# AIR FLOW AND CONTROL PARTS

For Model: AD50USL3

DEHUMIDIFIER



Illus. No.	Part No.	DESCRIPTION
1	LIT1186973 LIT1185020	Literature Parts Wiring Diagram Use & Care Guide
3	1184916	Assembly, Control Panel Electronic
5	488480	Screw, Sm #8 x 1/2
6	1183427	Bracket, Motor Panel,
7	1168758 1168759	Air System Left Side Right Side
10	1168839	Motor, Fan
11	1168661	Blade, Fan
12	1168681	Cover, Air System
13	1186481	Switch, Bucket Fill/Check
14	1159222	Screw, 8-18 x .295
15	1186815	Cord, Appliance W/ Wiring Harness
16	1168666	Plate, Orifice
17	488130	Nut
22	488937	Relief, Strain
23	1184946	Support, Air System
25	857547	Tie, Cable
26	1168752	Brace, Support
27	1157158	Screw, 8-18 X 3/8
28	1180634	Edge Guard

FOR ORDERING INFORMATION REFER TO PARTS PRICE LIST

# UNIT PARTS

For Model: AD50USL3

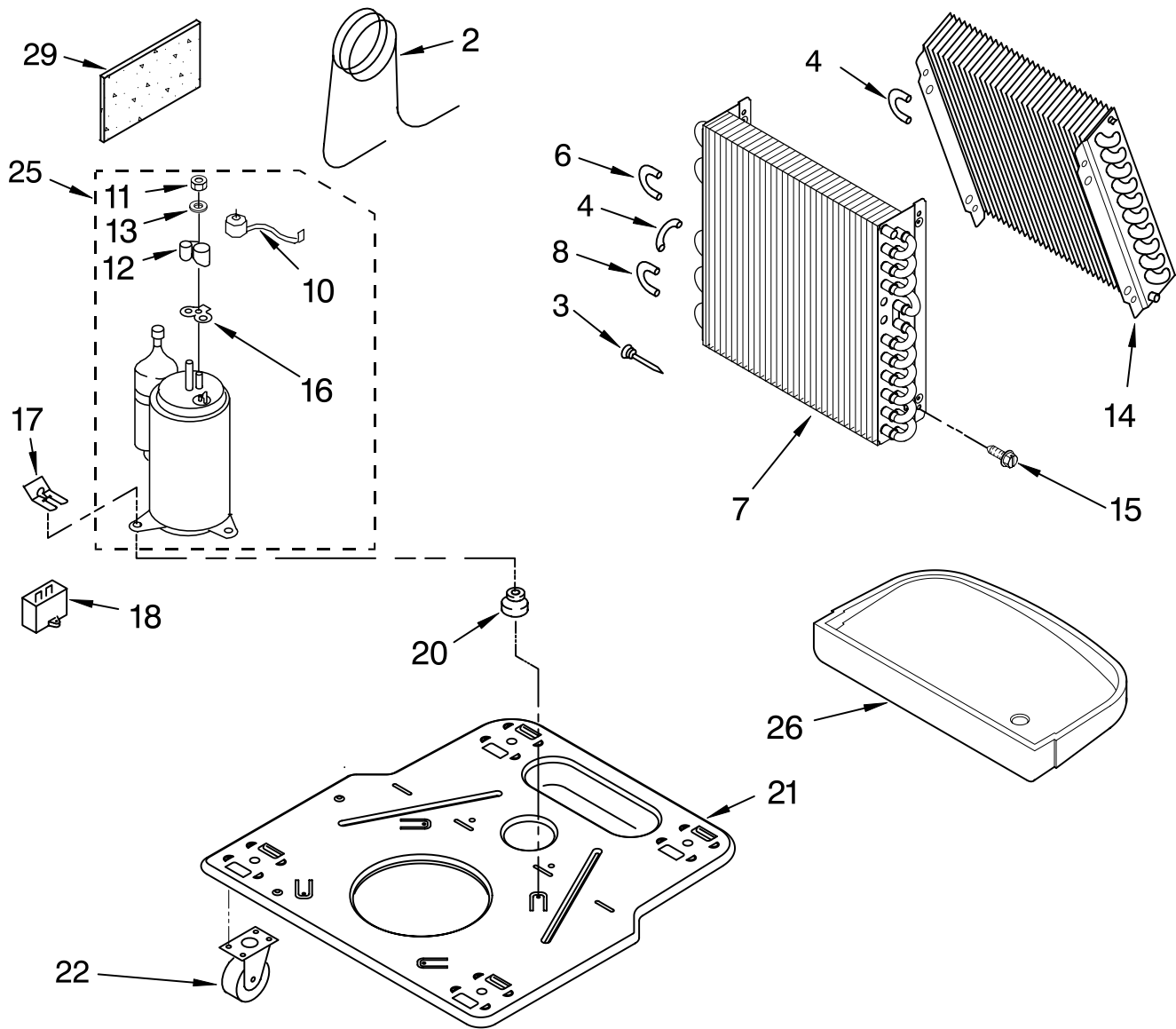

Illus. No.	Part No.	DESCRIPTION
2	1168734	Tube, Restrictor (Length 30.00")
3	1162526	Strainer
4	708532	Bend, Return Evaporator (9)
6	8031223	Bend, Return Condenser (2)
7	1186756	Condenser
8	8031222	Bend, Return (15)
10	1186712	Overload, Protector

Illus. No.	Part No.	DESCRIPTION
11	1186128	Nut, Terminal Cover
12	1184748	Cover, Terminal
13	1182120	Gasket, Nut
14	1185204	Evaporator
15	488480	Screw, 8 x 1/2 (4)
16	1182118	Gasket, Terminal Cover
17	8011446	Clip, Compressor
18	1186186	Capacitor
20	1186709	Grommet (3)
21	1186674	Base

Illus. No.	Part No.	DESCRIPTION
22	1164241	Caster (4)
25	1186706	Compressor, (Complete Assembly)
26	1168761	Pan, Drain
29	1184625	Insulation (Restrictor Tube)

## REFRIGERANT CHARGE

9.50 oz.

FOR ORDERING INFORMATION REFER TO PARTS PRICE LIST

# CABINET PARTS

For Model: AD50USL3

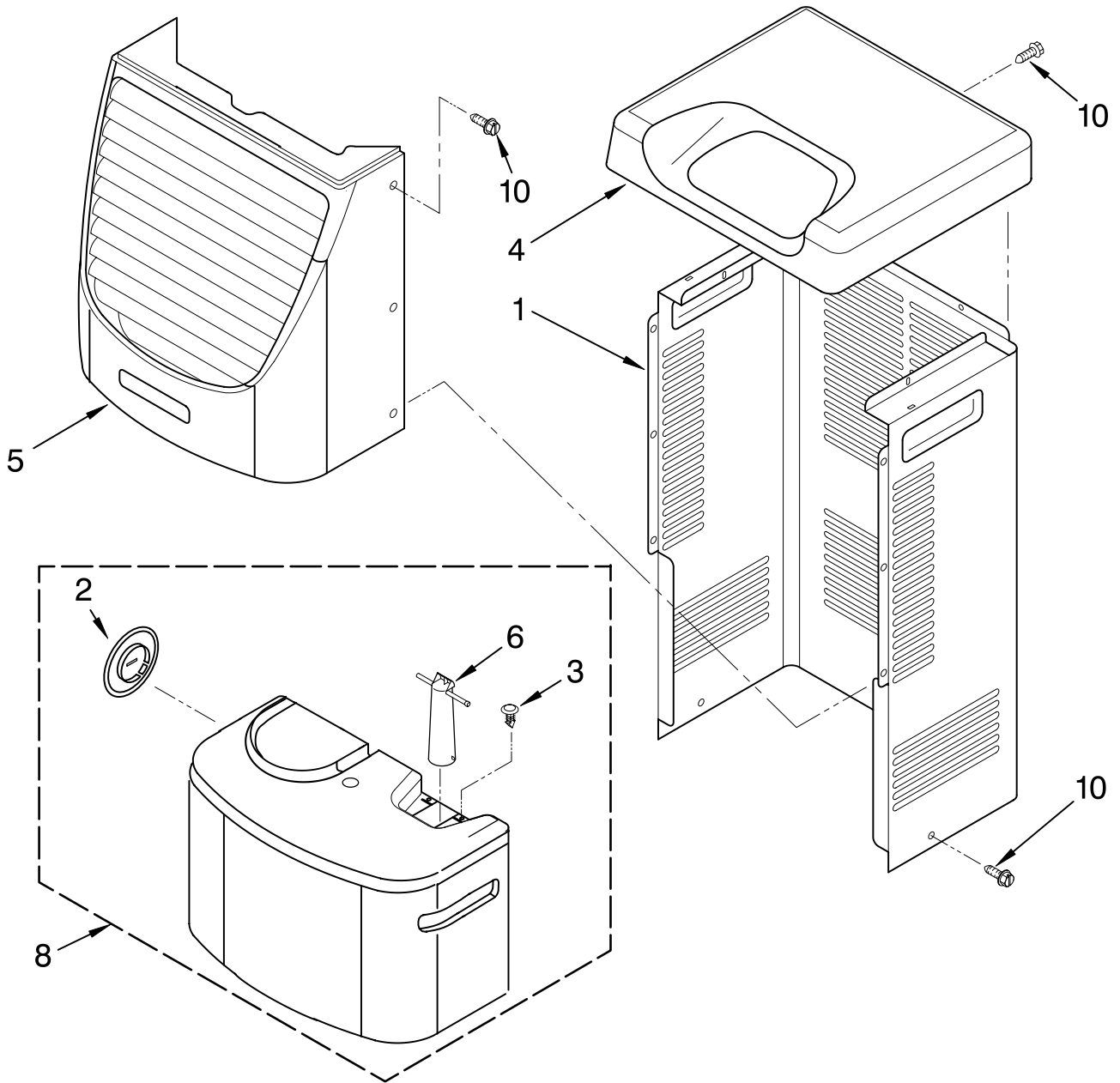

Illus. No.	Part No.	DESCRIPTION
1	1186822	Cabinet
2	1172098	Cover, Hose Connection
3	1186430	Clip, Float
4	1168652	Cover, Top
5	1182600	Cover, Front
6	1172075	Float
8	1182588	Bucket, Condensate
10	1168744	Screw

Illus. No.	Part No.	DESCRIPTION
Following Parts Not Illustrated and Optional Parts Not Included		
	484310	Epoxy, Tube (Aluminum Repair)
	505168	Tape, No Drip Valve, Access

Illus. No.	Part No.	DESCRIPTION
	978025	1/4" Tube O.D.
	978026	5/16" Tube O.D.
	978027	3/8" Tube O.D.
	978028	1/2" Tube O.D.
	978029	5/8" Tube O.D.
	978030	3/4" Tube O.D.
	978865	Seal, Ring Access Valve (20 Pack)

FOR ORDERING INFORMATION REFER TO PARTS PRICE LIST