

This Owner's Manual is provided and hosted by [Appliance Factory Parts](#).

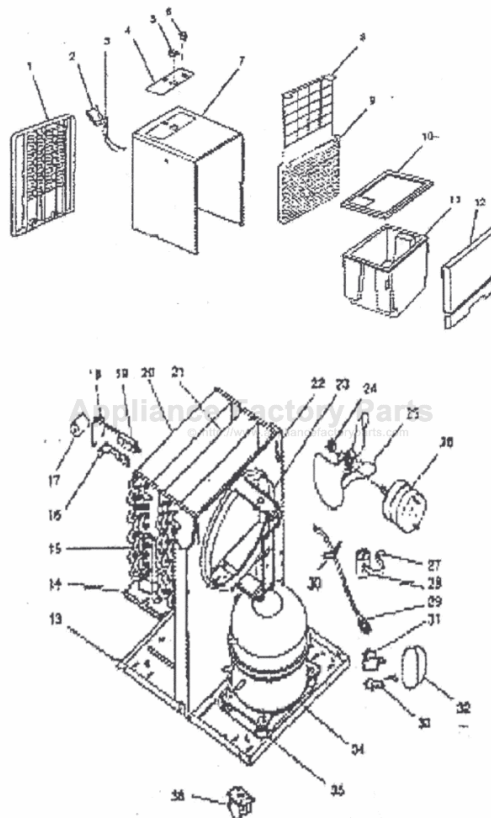

HAMPTON BAY HB40-C Owner's Manual

[Shop genuine replacement parts for HAMPTON BAY
HB40-C](#)



[Find Your HAMPTON BAY Dehumidifier Parts - Select From 59 Models](#)

----- Manual continues below -----

HB3D, HB4D,
HB5D

INSTALLATION & OPERATIONS MANUAL

*Including Service and Warranty
Incluidos mantenimiento y la garantía
Avec service et garantie*



Hampton Bay
*Dehumidifiers
Deshumidificadores
Déshumidificateurs*

CONTENTS

1

ENGLISH

Electrical Requirements.....	2
Warning	
Important Grounding Requirements	
Installation.....	3
Installation Requirements	
Leave at Least 10" Clearance	
Close Windows and Doors	
Plug In	
Operation.....	4
Automatic Humidity Control	
Special Design Prevents Freeze-Up	
Overflow Indicator (on most models)	
Water Disposal (with container)	
Water Disposal (without container)	
Filter Cleaning	
Service.....	6
If the Dehumidifier Fails to Start	
Unit Runs, But Very Little Water is Collected	
Save Electricity and Prevent Freeze-Up	
Sounds	
Service or Parts Required	
Warranty.....	6

ESPAÑOL

Requisitos para la eléctricos.....	8
Aviso	
Requisitos importantes para la conexión a tierra	
Instalación.....	9
Requisitos de instalación	
Deje un espacio de por lo menos 10" (25 cm)	
Cerrar ventanas y puertas	
Enchufar	
Funcionamiento.....	10
Control automático de la humedad (en la mayoría de modelos)	
El diseño especial impide la congelación	
Indicador de desbordamiento (en la mayoría de modelos)	
Eliminación del agua (con depósito)	
Eliminación del agua (sin depósito)	
Limpieza del filtro	
Servicio.....	12
Si no arranca el deshumidificador	
La unidad funciona pero se reúne muy poca agua	
Ahorrar electricidad y impedir la congelación	
Ruidos	
Necesidad de servicio o piezas	
Garantía.....	13

FRANÇAIS

Exigences électrique.....	15
Avertissement	
Avvis	
Importantes exigences de mise à la terre	
Montage.....	16
Caractéristiques d'installation	
Permettre un minimum de 10" (25 cm) de dégagement	
Fermez les portes et fenêtres	
Branchement	
Fonctionnement.....	17
Contrôle automatique d'humidité (sur la plupart des modèles)	
La conception spéciale empêche le givre	
Indicateur de débordement (sur la plupart des modèles)	
Évacuation de l'eau (avec le réservoir)	
Évacuation de l'eau (sans réservoir)	
Nettoyage du filtre	
Service.....	19
Si le déshumidificateur ne se met pas en marche	
L'appareil fonctionne, mais ne recueille que très peu d'eau	
Réduire la consommation d'électricité et empêcher le givre	
Bruits	
Réparations ou pièces s'avèrent nécessaires	
Garantie.....	20

INSTALLATION

⚠ WARNING

Electrical Shock Hazard

1. Plug unit only into grounded electrical outlet.
2. Do not use an extension cord or plug adaptor with this unit.
3. Do not operate unit with front removed.

Failure to follow the above precautions could result in electrical shock, fire or personal injury.

If the dehumidifier has a serial plate rating of 115 volts and up to and including 7.5 amps, the unit may be on a fuse or circuit breaker with other devices. However, the maximum amps of all devices on that fuse or circuit breaker can not exceed the amps of the fuse or circuit breaker. The location of the serial plate that applies to this model can be found on the back page of this manual.

Notice

Do not operate the dehumidifier without proper time delay circuit protection. Refer to serial plate for proper power supply requirements.

RECOMMENDED CIRCUIT WIRE SIZES
(As installed per building code)

PROTECTOR SIZE	WIRE GAUGE
15 AMP	#14 MINIMUM
20 AMP	#12 MINIMUM
30 AMP	#10 MINIMUM

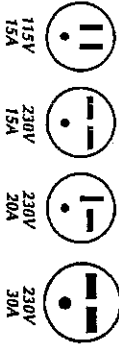

⚠ WARNING

For Your Safety:

Do not store or use gasoline or other flammable vapors and liquids in the vicinity of this or any other appliance. The fumes can create a fire hazard or explosion.

Power Supply: 115V, 60HZ
AC Only 1-Phase

Outlet Requirement: 3-Prong Grounding Type
125 V, 15 Amp

Minimum Wire Size: #14 (A.W.G.) 3-Wire
Use Copper Wire Only

Circuit Protector: 15 Amp Time Delay Fuse
or Circuit Breaker

1. ELECTRICAL REQUIREMENTS

1 Grounded three-prong wall receptacle



2 Single outlet grounding receptacle

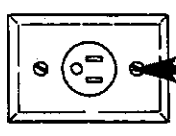

Three-prong grounding plug



Important Grounding Requirements

Your Dehumidifier will operate on any 115 volt, 3-pronged (grounded), 60 Hz circuit. A separate line is not required, but it is advisable not to overload the circuit with heavy duty appliances such as washing machines, etc. For your safety, this dehumidifier is equipped with a 3-pronged, grounding plug and must be plugged into a properly grounded outlet (Figs. 1 & 2). If your outlet is not of the proper type, it is your responsibility to have the outlet and wiring changed to the correct type. **DO NOT** cut off the third (grounding) prong. **DO NOT USE AN ADAPTER.**

2. INSTALLATION REQUIREMENTS

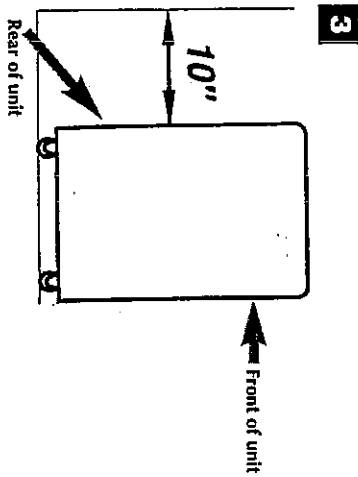

This dehumidifier has been carefully engineered, manufactured and tested to give you many years of comfort and dependable operation.

THIS IMPORTANT INFORMATION tells you all you need to know about installing, using and caring for your new Dehumidifier. Keep it handy, it will answer your questions, save you time and expense of unnecessary service calls, and insure that, as the owner of this superb appliance, you receive maximum comfort and enjoyment for many years.

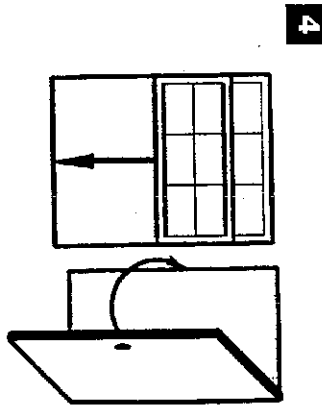

Leave at Least 10" Clearance

Your dehumidifier must be kept clear of any restrictions to air flow. Position unit at least 10" away from walls or other obstructions (Fig. 3).

Close Windows and Doors

To assure efficient dehumidification, close all windows and doors in the area where the dehumidifier is to operate (Fig. 4).

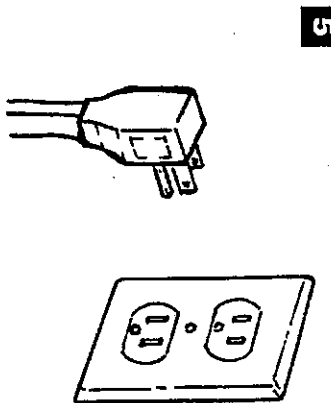

Plug In

Once you have assembled your dehumidifier and installed it in an appropriate location, plug the cord into a properly grounded outlet as indicated in the electrical requirements (Fig. 5).

OPERATION

3. CONTROL PANEL

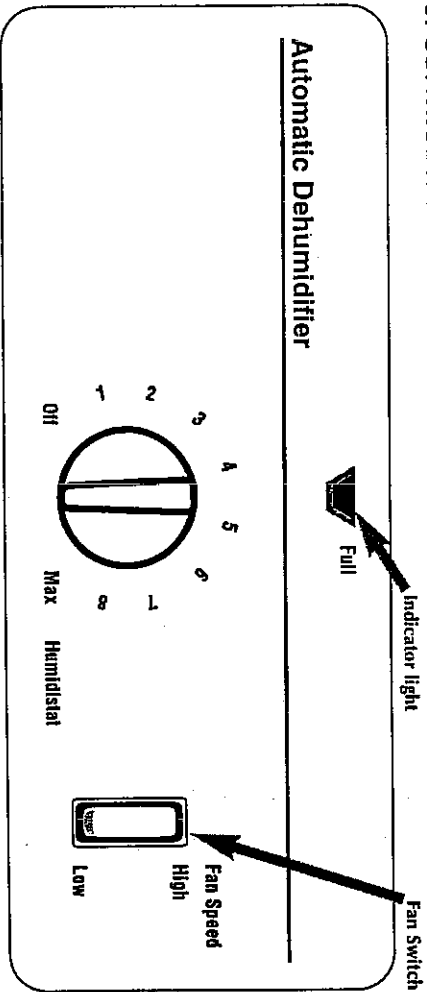

Pictured control panel is similar to your panel. FAN SWITCH: Some dehumidifiers feature a two-speed fan. Use the high speed to maintain maximum water removal. The lower speed can be used when quieter operation is desired.

Automatic Humidity Control

(on most models)

The humidistat control automatically turns your dehumidifier on or off to maintain the humidity level you select. Allow dehumidifier to reach room temperature, then turn control knob to number 5 (normal average setting). If unit does not turn on at this setting, this generally means that the relative humidity is already low and dehumidification may not be needed at this time.

After operating several days at this setting, with doors and windows closed, you may readjust this control to a slightly higher number for lower humidity (drier air) or to a slightly lower number for higher humidity (moist air).

Special Design Prevents Freeze-up

This design will allow your dehumidifier to operate as low as 65°F and 50% relative humidity without freeze-up. It features a specially designed dehumidifier coil with copper tubes mechanically bonded to full collared aluminum fins. This combination provides a superior surface area for dehumidification.

In general, dehumidification is not usually needed during conditions of low room temperature (below 65°F) or low relative humidity. Continued operation under these conditions may cause frost formation on the dehumidifying coil thus blocking the air circulation. To save electricity and prevent possible damage to the unit, it is best to turn the unit OFF.

Important: This water is not suitable for drinking.

Overflow Indicator

(on most models)

An automatic overflow switch and indicator light are provided on most models to turn the dehumidifier off before the container overflows. When the indicator light on the control panel glows, the water container must be emptied.

4. FRONT PANEL



- Water Disposal**
(with container)
1. Prior to removal of container, turn the Humidistat Control to OFF position.
 2. The handy container fits into the bottom front of dehumidifier and collects water

removed from the air. Use care so that the float rod will not be broken as the container is removed or replaced.

3. Re-insert the container, and reset the Humidistat Control to previous setting.

(permanent drain operation without container)

1. Unplug dehumidifier from power supply.
2. Remove water container from dehumidifier.
3. Use one of the supplied clips to lock bucket switcharm to sheetmetal bulkhead (Fig. 6).
4. With the water container removed, and the dehumidifier positioned over a floor drain, water can flow directly through the opening provided in the base into the drain, OR with the water container removed, a garden hose may be attached to permit draining the water to a remote drain. The special thread* on the drain pan will facilitate quick attachment of the hose.
5. The bucket front cover can be placed back on the unit for aesthetic purposes. Simply press on either side of the container to release tabs. Insert the clips (supplied) into the bucket front cover as illustrated. Push this piece, with clips assembled, into opening in front of the unit as illustrated (Fig. 6).

* Only threaded half-way around.
Proper use and care of your dehumidifier will help ensure longer life of the unit. It is recommended to annually inspect and clean the coils and condensate water passages. Expense of annual inspection is the consumers' responsibility.



Filter Cleaning

1. Use a vacuum cleaner attachment or brush to clean the front grille.
2. Remove the filter by sliding the filter up using the two recessed "finger-tip" tabs (Fig. 7).
3. To clean the filter, wash in warm, soapy water, rinse and shake dry. Cleaning is recommended monthly, or as conditions require.
4. For cleaning the water container, remove the top (if equipped) and wash with warm soapy water.

SERVICE & WARRANTY

Service

(Read carefully before calling for service)

If the Dehumidifier Falls to Start

- Make sure the unit is plugged into an operating outlet and the control knob is turned to the number "8" position.
- If the indicator light (most models) is on, empty the full water container. The indicator light should now go OFF, and the dehumidifier will begin to operate so be sure to quickly reinsert the empty water container. If the dehumidifier does not begin to operate check the float arm to be sure it is free to operate. This is located in the water container compartment.

Unit Runs, But Very Little Water is Collected

- The amount of water removed from the air depends on the relative humidity of the air and the capacity of the dehumidifier purchased. When the air feels damp (high relative humidity), more moisture will be removed and the container will fill up more rapidly. As the unit continues to remove moisture and reduce the humidity in the area, less water will be collected in the container.

Save Electricity and Prevent Freeze-up

- In general, dehumidification is not usually

needed during conditions of low room temperature (below 65°F) or low relative humidity. Continued operation under these conditions may cause frost formation on the dehumidifying coil thus blocking the air circulation. To save electricity and prevent possible damage to the unit, it is best to turn the unit OFF.

Sounds

- It is reassuring to know that your dehumidifier is functioning properly. These are some normal sounds which should not be a cause for concern:
- Air rushing over air drying coils.
 - Hissing or thumping - refrigerant is flowing throughout the sealed system and may generate a "boiling" sound right after the compressor stops.
 - Compressor may "thump" as it cycles on and off.
 - Water dripping from coils onto the drain plate.
 - The humidistat control, compressor and fan "tick" as they turn on and off. Metal makes a similar sound when expanding or contracting.

For Models Installed in North America - If Service or Parts are Required

First, make the recommended checks. If it appears that service or parts are still required, see your dehumidifier warranty "How to Obtain Warranty Service or Parts".

For Models Installed Outside North America

For dehumidifiers purchased for use outside North America, the manufacturer does not extend any warranty either expressed or implied. Consult your local dealer for any warranty terms extended by the importer in your country.

Dehumidifier Warranty

(Within the 48 contiguous United States, state of Hawaii, the District of Columbia, Puerto Rico, and Canada)

Fall (One Year) Parts and Labor Warranty

During the first year after the date of original purchase, Hampton Bay will, through its authorized servicers and free of charge to the owner or any subsequent user, repair or replace any parts which are defective in material or workmanship due to normal use when the dehumidifier is delivered by the owner to and picked up from one of our authorized servicers. If requested, in-home service, pick up, redelivery and reinstallation will be provided, but are the owner's responsibility.

Limited (Second Through Fifth Year)

Sealed System Warranty

If any part of the sealed refrigerant system (consisting of compressor, evaporator, condenser, and interconnecting refrigerant tubing) should fail because of a defect in material or workmanship (including refrigerant charge), within the second through fifth year from the date of original purchase, Hampton Bay, through its authorized ser-

viewers, will repair or replace such part, including labor, at no cost to the owner when the dehumidifier is delivered by the owner to and picked up from one of our authorized servicers. If requested, in-home service, pick up, redelivery and reinstallation will be provided, but are the owner's responsibility.

Note: In the event of any required parts replacement within the period of this warranty, Hampton Bay replacement parts shall be used and will be warranted only for the period remaining on the original warranty.

Exceptions

The above Limited Warranties does not cover failure to function caused by damage to the unit while in your possession (other than damage caused by defect or malfunction), or by its improper installation, or by unreasonable use of the unit, including without limitation, failure to provide reasonable and necessary maintenance or to follow the written Installation and Operating Instructions. If the unit is put to commercial, business, rental, or other use or application other than for consumer use, we make no warranties, express or implied, including but not limited to, any implied warranty of merchantability or fitness for particular use or purpose.

THE REMEDIES PROVIDED FOR IN THE ABOVE EXPRESS WARRANTY ARE THE SOLE AND EXCLUSIVE REMEDIES THEREFOR. NO OTHER EXPRESS WARRANTIES ARE MADE. ALL IMPLIED WARRANTIES, INCLUDING BUT NOT LIMITED TO ANY IMPLIED WARRANTY OF MERCHANTABILITY OR FITNESS FOR A PARTICULAR USE OR PURPOSE, ARE LIMITED IN

DURATION TO ONE YEAR FROM THE DATE OF ORIGINAL PURCHASE. IN NO EVENT SHALL HAMPTON BAY BE LIABLE FOR INDIRECT, INCIDENTAL, OR CONSEQUENTIAL DAMAGES, EVEN IF ADVISED IN ADVANCE OF THE POSSIBILITY OF SUCH DAMAGES. NO WARRANTIES, EXPRESS OR IMPLIED, ARE MADE TO ANY BUYER UPON RESALE.

Some states do not allow limitations on how long an implied warranty lasts or do not allow the exclusion or limitation of incidental or consequential damages, so the above limitations or exclusions may not apply to you. This warranty gives you specific legal rights, and you may also have other rights which may vary from state to state.

No warranties are made for units sold outside of the above stated areas. Your distributor or final seller may provide a warranty on units sold outside of these areas.

How to Obtain Warranty Service or Parts
Service for your dehumidifier will be provided by CareCo, a division of the manufacturer with authorized independent servicers nationwide.

Note: Before calling for service, carefully read the Installation and Operating Instructions booklet. Then if you need service:

1. Call a CareCo authorized servicer and advise them of model number, serial number, date of purchase and nature of complaint. Service will be provided during normal working hours. Contact your dealer for the name of an authorized servicer if unknown to you.

2. If your dealer is unable to give you the name of a servicer or if you need other assistance, call the following toll-free number for the name of an authorized servicer or authorized parts distributor:
1-800-345-4494
or you may write:

**CareCo, Service Department
415 W. Wabash Ave., P.O. Box 200
Effingham, IL 62401**

Proof of Purchase Date
It is the responsibility of the consumer to establish the original purchase date for warranty purposes. We recommend that a bill of sale, cancelled check, or some other appropriate payment record be kept for that purpose.