

READ AND SAVE THESE INSTRUCTIONS

White  
Rodgers

**Comfort**  
Premium IAQ Products **plus**<sup>TM</sup>

## Installation Instructions\* for High-Capacity Steam Humidifiers (Models HSP2000 and HSP2600)

Also includes:

- Programmable Flushing Timer  
Installation Instructions
- Operating and Maintenance Instructions

**CONTRACTOR:** Read these instructions before installing or servicing humidifier

**HOMEOWNER:** Save this manual for future reference.

Model No: \_\_\_\_\_

Mfg. Date (see label on unit): \_\_\_\_\_

Installation Date: \_\_\_\_\_



\*See "Wiring Instructions for High-Capacity Steam Humidifiers" separately

# Table of Contents

	Page
<b>CONTRACTOR:</b>	
How To Install a White-Rodgers ComfortPlus Steam Humidifier.....	3
• Safety Precautions.....	3
• Tools & Materials Needed.....	4
Selecting a Location.....	4
Mounting the Humidifier (Options A-C).....	5
Plumbing and Setting the Water Level.....	8
How To Install the Programmable Automatic Flushing Timer.....	10
• To Reprogram the Automatic Flushing Timer.....	11
How to Maintain a White-Rodgers Steam Humidifier.....	12
Troubleshooting.....	14
Replacement Parts.....	15
<b>HOMEOWNER:</b>	
How Your Humidifier Works.....	17
How To Extend the Life of Your Humidifier.....	18
FAQs about IAQ.....	19
Contact Information.....	20 (Back Cover)

# For the Contractor:

## How To Install a White-Rodgers ComfortPlus Steam Humidifier

**NOTES:** This humidifier must be installed by a qualified professional contractor. Failure to comply with this requirement may nullify the warranty.

Read all instructions before beginning installation of the humidifier. White-Rodgers assumes no responsibility under warranty if the contractor and/or user do not follow these printed instructions.

**FOR WIRING INSTRUCTIONS AND INSTALLATION OF THE ELECTRONIC COMPENSATING HUMIDISTAT, PLEASE SEE SEPARATE INSTRUCTIONS ENCLOSED IN THE HUMIDIFIER CARTON.**

### Safety Precautions

1. Do not install a humidifier where the surrounding temperature may exceed 200°F.  
**CAUTION:** Excessive heat will damage the humidifier, possibly causing an overflow condition and water damage to the home.
2. Do not install a humidifier where the surrounding temperature may be 32°F or colder (e.g., attics, garages, etc.).  
**CAUTION:** Freezing water will damage the humidifier and burst the supply pipe, resulting in damage to the home.
3. Do not cut or drill into any air conditioning components or electrical enclosures during humidifier installation.  
**DANGER:** Electrocutation is possible if you come in contact with a live electrical wire. Blindness can occur if refrigerant contacts your eyes.
4. When the humidifier is installed in a finished basement or any area where water damage could occur, be sure to connect the humidifier's overflow provision to a suitable drain.
5. For above-ceiling installations, install an additional drain pan plumbed to a suitable drain.
6. Installation, wiring and plumbing of the humidifier must comply with local codes, ordinances and regulations.

## Tools and Materials Needed

1. Safety glasses
2. Tin snips or aviation snips
3. Electric drill
4. 3/8" and 7/64" drill bits
5. Pliers
6. Screwdrivers (medium flat point and Phillips #1)
7. Level
8. Hammer
9. Small adjustable wrench
10. Center punch
11. Knife
12. Wire and hardware to connect fan control
13. Additional relay(s)

### For some installations:

14. Duct tape
15. 1/4" copper water line
16. Tubing and fittings for the overflow connection
17. 2 conductor low-voltage wire

## Selecting a Location

1. For most installations, mount the humidifier under the horizontal warm air supply duct. As an alternative, the unit can be mounted on a vertical plenum using a fabricated transition for support. (See "Mounting the Humidifier", pages 5-7.)

**NOTE:** Ideally the White-Rodgers ComfortPlus Steam Humidifier is not intended for installation in or on the return air duct or plenum. However, some contractors do so without complications. **If you choose to install a ComfortPlus Steam Humidifier under a return air duct or on a return air plenum, be aware that moisture MUST be absorbed BEFORE entering the filter, blower, turn or transition. Therefore, INSTALL THE HUMIDIFIER AT LEAST 4-TO-6 FEET PRIOR TO THESE DEVICES AND CONFIGURATIONS.**

2. Select a location where the humidifier can be plugged in without the use of an extension cord. (See separate manual, "Wiring Instructions for High-Capacity Steam Humidifiers".)
3. Select a location that will not allow steam to condense on the system air mover, electrical components, etc.
4. Mount the unit on rigid metal ductwork, never on duct board or internally-insulated duct.

**CAUTION:** For all installation configurations, the mounting area must be strong enough to support the humidifier's weight when it is full of water (approximately 18 lbs.), and to hold the humidifier in a level position for safe, reliable operation. Otherwise, additional duct reinforcement will be necessary.

**NOTE:** If the installation includes exposed insulated materials, a section of the ductwork must be removed and replaced with rigid metal duct extending at least 6 feet downstream from the humidifier.

5. Mount the unit at least 4-to-6 feet after the plenum transition. Avoid sudden turns or transitions in the ductwork in the immediate area downstream from the humidifier.

## Mounting the Humidifier

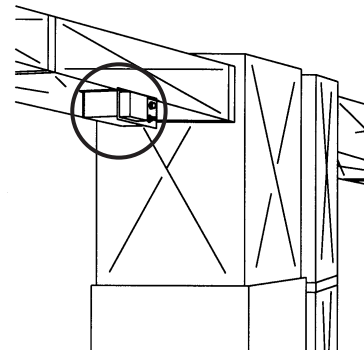

Figure 1—Option A:  
Duct Edge Mount

**Option A is the preferred method of mounting** because it requires the least amount of duct reinforcement to support the humidifier and keep it level. A duct width of at least 10 inches is necessary. Wider ducts may need to be reinforced in order to hold the humidifier level.

**DANGER: Wear safety glasses when cutting or drilling.** Do not cut or drill into any air conditioning components or electrical enclosures during installation. **Electrocution is possible if you come in contact with a live electrical wire; blindness can occur if refrigerant contacts your eyes.**

To install Option A:

1. Place the mounting bracket (provided) on the edge of the ductwork where the humidifier is to be installed.
2. Use a marker to trace around the inside of the mounting bracket. Cut out the duct opening.

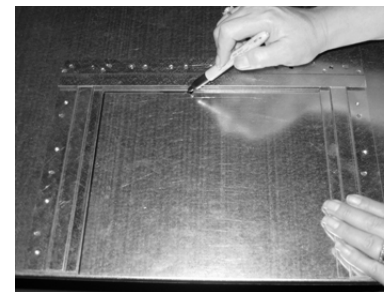

Figure 2—Mounting Bracket

**CAUTION: DO NOT** attach the mounting bracket before the hole in the ductwork has been cut.

3. Attach the mounting bracket to the ductwork with sheet metal screws.
4. Attach the L-shaped bracket to the top/front of the humidifier, so that the vertical wall is toward the reservoir.

- Adjust the water level. (See Nos. 7 & 8 in “Plumbing and Setting the Water Level”, pages 8 & 9.)
- Slide the flanges of the humidifier reservoir into the mounting bracket until the reservoir’s front flange comes in contact with the edge of the duct.
- Secure the humidifier to the duct with the screws provided.

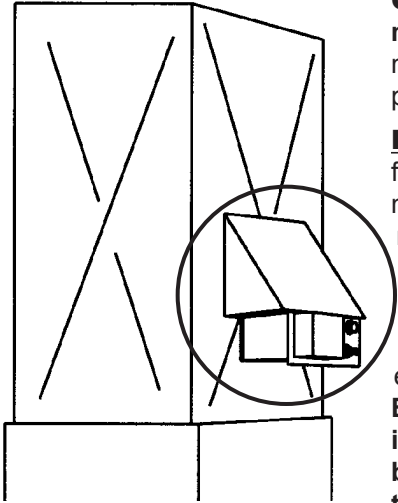

Figure 3—Option B:  
External Side Mount

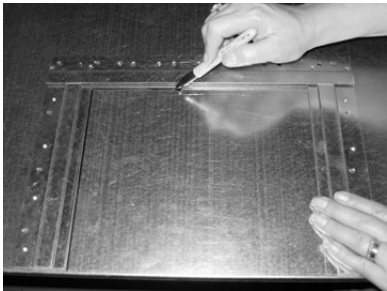

Figure 4—Mounting Bracket

- Attach the L-shaped bracket to the top/front of the humidifier so that the vertical wall is toward the reservoir.
- Adjust the water level. (See Nos. 7 & 8 in “Plumbing and Setting the Water Level”, pages 8 & 9.)
- Slide the flanges of the humidifier reservoir into the mounting bracket.
- Secure the humidifier to the duct with the screws provided.

**Option B** requires a transition to be made, and usually needs duct reinforcement to hold the humidifier securely in place.

**NOTE:** For this configuration, the humidifier is mounted on the outside of the plenum, rather than the inside, so as not to restrict airflow.

**DANGER:** Wear safety glasses when cutting or drilling. Do not cut or drill into any air conditioning components or electrical enclosures during installation. **Electrocution is possible if you come in contact with a live electrical wire; blindness can occur if refrigerant contacts your eyes.**

To install Option B:

- Construct a transition and attach it to the plenum. (Additional humidifier support will be necessary for this configuration.)
- Place the mounting bracket (provided) at the base of the transition.
- Use a marker to trace around the inside of the mounting bracket. Cut out the duct opening.

**CAUTION:** DO NOT attach the mounting bracket before the hole in the ductwork has been cut.

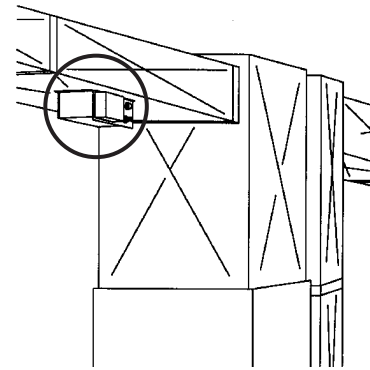

Figure 5—Option C:  
Duct Center Mount

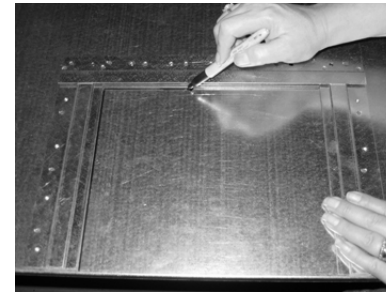

Figure 6—Mounting Bracket

- Slide the flanges of the humidifier reservoir into the mounting bracket.
- Secure the humidifier to the duct with the screws provided.

**NOTE:** See separate wiring instruction manual, “Wiring Instructions for High-Capacity Steam Humidifiers”.

**Option C** requires duct reinforcement to hold the humidifier securely in place.

**DANGER:** Wear safety glasses when cutting or drilling. Do not cut or drill into any air conditioning components or electrical enclosures during installation. **Electrocution is possible if you come in contact with a live electrical wire; blindness can occur if refrigerant contacts your eyes.**

To install Option C:

- Place the mounting bracket (provided) at the selected location on the bottom of the duct.
- Use a marker to trace around the inside of the mounting bracket. Cut out the duct opening.
- Attach the mounting bracket to the ductwork with sheet metal screws.
- Adjust the water level. (See Nos. 7 & 8 in “Plumbing and Setting the Water Level”, pages 8 & 9.)

## Plumbing and Setting the Water Level

**NOTE:** Use copper tubing only to plumb the humidifier.

1. Select the nearest cold water pipe and install the saddle connector and needle valve (provided) by following the instructions supplied with the valve.

**WARNING:** Do not use any line connected to an air conditioner.

2. Lightly clean the tubing ends with fine sandpaper before making connections.

3. Uncoil the copper tubing and connect one end to the saddle valve. Use the compression fittings found in the self-piercing saddle valve parts bag.

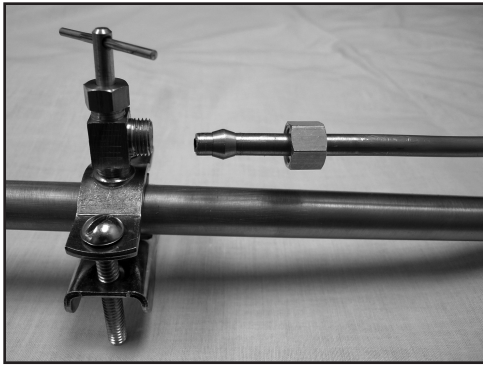

Figure 7—Saddle Valve and Fittings

- Place the brass compression nut over the tubing, then slide the brass ferrule over the tubing.
  - Fully insert the tubing into the saddle valve fitting and tighten the compression nut. (Do not over-tighten; moderate tightness should prevent leakage.)
  - Thoroughly flush the supply tubing after attaching it to the saddle valve. This will clear the line of debris which could block water flow at the float valve.
4. Route the tubing to the humidifier float valve, keeping the tubing away from sharp edges.
  5. Connect the remaining end of the tubing to the humidifier float valve.
  6. Open the saddle valve so that the water flows slowly and gently into the water pan.
  7. Prior to mounting, adjust the humidifier's water level by following these instructions:
    - Set the humidifier reservoir on a level surface.
    - Allow the unit to fill until the float valve shuts off the incoming flow of water. (The water should be 2-3/8" deep, plus or minus 1/8". If it is not, further adjustment will be necessary.)

**CAUTION:** To prevent valve seat damage, **never adjust the humidifier's water level without supporting the float arm.** Make adjustments in small increments.

- To raise the water level, push down in the center of the float arm. (See Figure 8-A, below.)
- To lower the water level, hold the float on the bottom of the reservoir with one hand and pull up on the center of the float arm with the other hand. (See Figure 8-B, below.)

TO RAISE WATER LEVEL

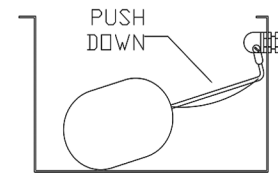

Figure 8-A—Raising the water level

TO LOWER WATER LEVEL

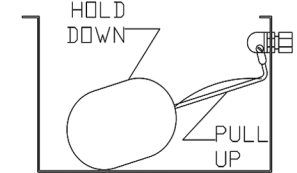

Figure 8-B—Lowering the water level

8. If the water level is too high, remove enough water from the reservoir to allow the float valve to automatically fill and shut off the water. This will verify that your final adjustment is correct.
9. Shut off the water supply and remove all water from the reservoir.
10. Mount the humidifier according to Options A, B or C, shown on pages 5-7.
11. Check the two compression fittings—one at the saddle valve, the other at the float valve. Stop any leakage by tightening the fittings.
12. Connect the humidifier's overflow provision to a suitable waste drain.
  - A standard garden hose or a 3/8" N.P.T. male fitting (not supplied) can be attached to the overflow fitting.
  - Provide support at many points along the hose to prevent kinks—particularly near any heat source.
13. Turn the water to the humidifier on. The float valve should shut the water off when the pan is filled to 2-3/8".
14. Make sure the humidifier is plugged into a powered outlet.
15. Adjust the compensating humidistat according to instructions provided with the unit.

## How To Install the Programmable Automatic Flushing Timer



The Humidifier Automatic Flushing Timer automatically flushes accumulated mineral deposits from all central-system steam- and reservoir-type humidifiers. This enables homeowners to enjoy the benefits of healthful, humidified air without the hassles of frequent maintenance due to mineral buildup.

The flushing timer is set at the factory to flush the humidifier every two hours for a duration of 10 seconds, using only about 1.5 gallons of water per day.

(See “To Reprogram the Automatic Flushing Timer”, pages 11 and 12, for alternate settings.) This flushing reduces or eliminates servicing during the humidification season, depending on the mineral content of the water.

### To Install the Flushing Timer on a Steam Humidifier:

**Figure 9**—Installation of a Programmable Automatic Flushing Timer on a Steam Humidifier

**CAUTION:** All plumbing and electrical connections must comply with relevant codes and ordinances.

1. If the humidifier has been preinstalled and needs servicing, refer to “How to Maintain a White-Rodgers ComfortPlus Humidifier” (page 12) for instructions.
2. For either a new or preinstalled humidifier, select a suitable mounting locations for the flushing timer within 3 feet of the humidifier, and within 10 feet of a properly fused electrical outlet.

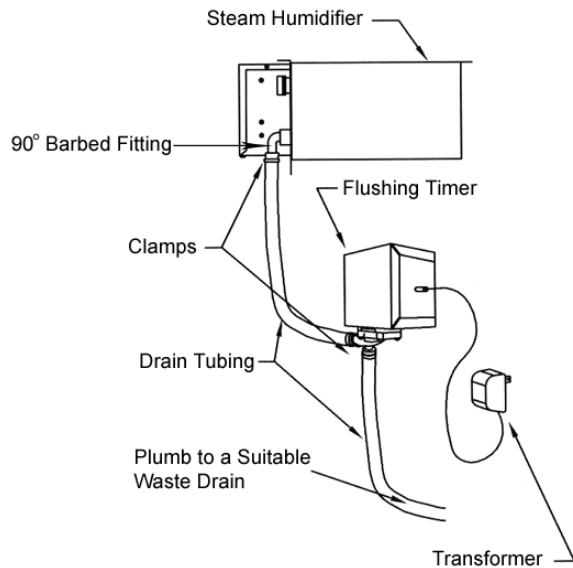

3. Locate a suitable waste drain for disposal of flushed water.  
**CAUTION:** Drain tubing must not kink or come in contact with sharp edges or hot surfaces. Tubing must run in a continual downhill slope to allow proper drainage and to prevent overflow.

- 4a. If this flushing timer was purchased as an accessory to install on a steam humidifier... remove the drain valve from the humidifier and install the 90° barbed fitting (provided). (See Figure 9 on page 10.)
  - 4b. If this flushing timer was purchased with the steam humidifier as a complete assembly... the 90° barbed fitting should already be installed on the humidifier in the proper location. (See Figure 9 on page 10.)
5. Screw the unit to the mounting surface selected in Step #2.
  6. Cut a piece of drain tubing to reach from the humidifier fitting to the fitting on the side of the flushing timer.

**CAUTION:** Drain tubing must not kink or come in contact with sharp edges or hot surfaces. (This caution applies to step #7, as well.)

7. Cut a second piece of tubing to reach from the bottom fitting on the flushing timer to the drain. (See Step #3.)
8. Connect tubing with clamps or fittings suitable for your installation.
9. Return the steam humidifier to its normal operating mode. Refer to pages 8 & 9 to properly set the water level.
10. Plug the flushing timer into the designated outlet. (See Step #2.)
11. Check all fittings for leaks. Tighten as necessary.
12. Test the flushing timer for proper operation.
  - A. Press and release the MANUAL button.
  - B. Wait 10 to 30 seconds\* until the flushing noise stops, indicating that the flushing cycle is complete.

*\*The number of seconds will vary depending upon how the unit is programmed. (See “To Reprogram the Automatic Flushing Timer”, below.)*

### To Reprogram the Automatic Flushing Timer:

The flushing timer is set at the factory to flush the humidifier every two hours for a duration of 10 seconds, using approximately 1.5 gallons of water per day. Although the two-hour intervals between flushes may not be altered, the duration may be lengthened to either 20 or 30 seconds per flush.

1. Unplug the flushing timer from the electrical outlet.
2. Take off the back cover plate by removing the three screws closest to the mounting flanges.

3. Inside, on the circuit board, locate the red switch block which contains two switches, numbered 1 and 2.

**NOTE:** The switches are pre-set in the 10-second mode, with the #1 switch in the ON position and the #2 switch in the OFF position, as shown at right. (Both switches in the ON position will also produce a 10-second flush.)

**10 Sec.**

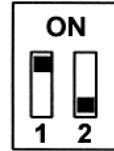

4. To reprogram the flushing timer to 20-second flushes every 2 hours, move the #1 switch to the OFF position and the #2 switch to the ON position, as shown at left. At this setting, the automatic flushing timer will use approximately 3 gallons of water per day.

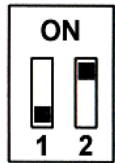

5. To reprogram the flushing timer to 30-second flushes every 2 hours, move both switches to the OFF position, as shown at right. At this setting, the automatic flushing timer will use approximately 4.5 gallons of water per day.
6. Reposition the back cover plate on the flushing timer and secure it with the three screws.
7. Plug the flushing timer back into the wall outlet. Make sure it is functioning properly with the humidifier (see Step #12, page 11).

**30 Sec.**



**NOTE:** Lengthening the flushing duration will help keep the humidifier cleaner. However, it may also cause undesirable drain noise.

## How to Maintain a White-Rodgers ComfortPlus Steam Humidifier

Because the White-Rodgers ComfortPlus Steam Humidifier is designed to emit mineral-free moisture into the air, the unit should be cleaned and serviced every two-to-four months during the humidification season. Harder water, colder weather and/or higher humidistat settings will increase the frequency of required cleaning and service.

**NOTE:** A White-Rodgers Automatic Flushing Timer (see page 18) can reduce maintenance significantly. However, it is still wise for the homeowner to check the humidifier for mineral buildup every two months or so.

To perform routine maintenance tasks, follow these instructions:

**WARNING:** Do not touch the humidifier when the operation indicator light is on. Always unplug the unit and allow it to cool prior to service or inspection.

1. Unplug the humidifier and fan control; disconnect the humidistat wires from the external screw terminals.
2. Turn off the water supply and disconnect the supply tubing at the float valve. Disconnect the overflow hose at the humidifier.
3. Allow water in the humidifier to cool before continuing.

**WARNING:** Scalding is possible if water in the humidifier reservoir has not been allowed to cool.

4. Use the automatic flushing timer to drain the unit by following these instructions:
  - A. Press and release the MANUAL button on the flushing timer.
  - B. Wait 10 to 30 seconds until the flushing noise stops, indicating that the flushing cycle is complete. (The number of seconds will vary depending upon how the timer is programmed.)
  - C. Repeat Steps A and B until the humidifier is drained.
5. Remove the humidifier from its mounting.
6. Flush loose minerals from the reservoir and water, then gently rub minerals off the float, heater, reservoir walls and safety float switch. If mineral deposits have been allowed to build up, steel wool or other scouring pads may be used.
7. Inspect the valve arm and float for mineral buildup and deterioration.

**CAUTION:** If deterioration is noted on parts, replacement will be necessary.

8. Reset the water level. (See Steps 7 & 8 of "Plumbing and Setting the Water Level", pages 8 & 9.)
9. Remount the humidifier and make all electrical and plumbing reconnections. Check for leaks or overflow. Set the humidistat as directed in the humidistat instructions.

**CAUTION:** Never oil any part of the humidifier.

**NOTE:** At the end of each humidification season (approximately the same period as the heating season), the humidifier should be thoroughly cleaned and the water and electricity turned off until the next humidifying season.

**CAUTION:** Do not leave water in the humidifier over the warm-weather months.

## Troubleshooting

PROBLEM	EVIDENCE	SOLUTIONS
<b>Low Humidity</b>	Low water level (less than 2-3/8" deep)	<ul style="list-style-type: none"> <li>• See <i>Plumbing and Setting Water Level</i>, Steps 7 &amp; 8, pgs. 8 &amp; 9</li> </ul>
	No water in reservoir	<ul style="list-style-type: none"> <li>• Turn water on at saddle valve</li> <li>• Turn off water main and check for possible obstruction in saddle valve or float valve</li> </ul>
	Humidifier heater is not operating	<ul style="list-style-type: none"> <li>• Make sure the humidifier is plugged in</li> <li>• Set the humidistat higher</li> <li>• Check for blown circuit breaker</li> <li>• Check all external wiring connections</li> <li>• Check for low water level</li> <li>• Check the humidistat switch for continuity</li> <li>• Call a professional HVAC contractor</li> </ul>
	Rapid air changes (drafts)	<ul style="list-style-type: none"> <li>• Keep doors and windows closed (cold, dry air is an added load on the humidifier)</li> <li>• Close fireplace damper when not in use</li> <li>• Keep exhaust fan running time to a minimum</li> <li>• Seal around doors and windows</li> </ul>
<b>High Humidity</b>	Condensation on walls	<ul style="list-style-type: none"> <li>• Turn humidistat off</li> <li>• Turn water to humidifier off until condensation is evaporated</li> </ul>
	Heavy condensation on windows	<ul style="list-style-type: none"> <li>• Turn humidistat down enough to eliminate condensation (this may be a temporary condition caused by moisture from bathing, mopping, cooking, etc.)</li> </ul>
<b>Humidifier Overflows</b>	High water level	<ul style="list-style-type: none"> <li>• Inspect valve seat for defects</li> <li>• Inspect valve nozzle for cracks or erosion</li> <li>• Readjust water level (see <i>Plumbing and Setting Water Level</i>, Steps 7 &amp; 8, pgs. 8 &amp; 9)</li> <li>• Make sure humidifier is level</li> </ul>

Table 1

## Replacement Parts

**Contractors:** Parts may be ordered through your preferred heating or plumbing distributor. When ordering, refer to the appropriate parts list (below and on page 16) to give the following information:

- Humidifier Model Number
- Part Name
- Part Number
- Humidifier Manufacturing Date (see label on side near drains)

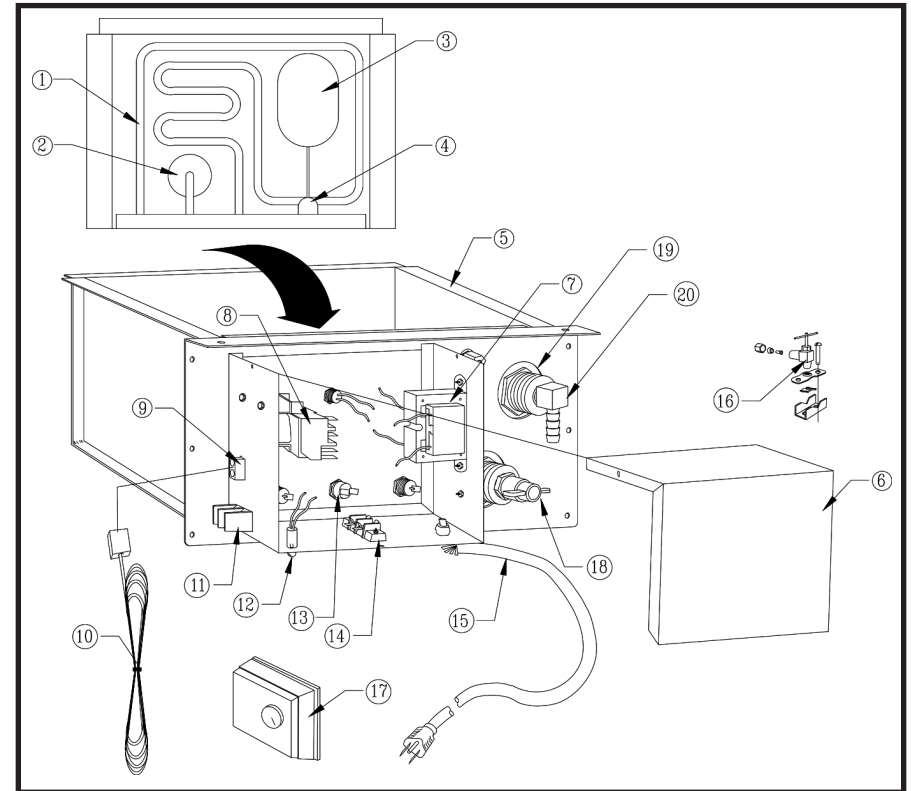

Figure 10—Parts Diagram of Models HSP2000 and HSP2600

Parts for Models HSP2000 and HSP2600		
Item	Part Name	Part No.
1*	120 Volt Heater	000-0430-055
1**	240 Volt Heater	000-0430-056
2	Safety Float Switch	000-0814-132
3	Float for Water Fill Valve	A00-1309-012
4	Water Fill Valve	000-1731-012
5	Water Pan Assembly	A01-1730-078
*Model HSP2000 **Model HSP2600		continued...



Parts for Models HSP2000 and HSP2600 (cont'd.)		
Item	Part Name	Part No.
6	Cover	000-0641-150
7*	Transformer 120 Volt Primary, 24 Volt Secondary	000-0814-133
7**	Transformer 240 Volt Primary, 24 Volt Secondary	000-0814-140
8	Control Relay DPST 24 Volt	000-0431-031
9 & 10	Fan Wiring Assembly	A00-0811-120
11	Humidistat Control Terminal Block	000-0814-135
12	Indicator Light	000-0814-139
13	Thermal Fan Control "Thermostat"	000-0431-030
14	Power Distribution Terminal Block	000-0814-134
15*	120 Volt Power Supply Cord	000-0811-107
15**	240 Volt Power Supply Cord	000-0811-108
16	Saddle Valve	A00-1128-005
17	Compustat Assembly	SEH-7100-000
18	Drain Cock Valve	000-1319-065
19	Drain & Overflow Bushing (w/Overflow Bushing, Washer & Lock Nut)	A00-1319-067
20	90° Barbed Elbow	000-1106-034
Not Shown	9 pc. Gasket Set (w/Drain, Overflow, Thermostat, Safety Float & Heater Washers)	A00-0693-020
*Model HSP2000 **Model HSP2600		

Table 2

## For the Homeowner: How Your Humidifier Works

Your White-Rodgers Comfort-Plus Steam Humidifier supplies moist air to your home much the same way as outdoor air is humidified. On a warm summer day, the sun's heat evaporates water from puddles, streams, rivers, oceans, etc., turning it into vapor (*humidity*). The amount



of water vapor that rises into the air is determined by the amount of time the water is exposed to the heat source.

If you were to look inside your humidifier's reservoir, you would see an immersed, tubular heater and two floats. When your home is too dry, the humidistat (humidity control device) installed with your system activates the humidifier heater. A built-in thermostat senses the water temperature and, when the water is hot enough, turns on a relay to activate the blower on your furnace. The blower, independent of your home's heating system, disperses humidified air throughout the house. In other words, the heat necessary for evaporation is supplied by the humidifier itself, rather than by your furnace.

Once the selected level of humidity is reached, the humidifier heater turns off automatically. However, the furnace blower continues to replenish the moisture in your home until the water in the humidifier's reservoir is cooled and ceases to produce steam. All this takes place without disrupting your heating system's normal operation. When the indoor humidity drops below the desired level, the process begins again.

As water is evaporated from the humidifier reservoir and replaced by fresh water, the larger of the two float valves prevents overflow by shutting off the water at the designated level. The smaller float acts as an additional safety device, automatically shutting off the humidifier heater if, for any reason, the water level drops below the heating element.

Because water evaporated from the humidifier leaves behind all its impurities (calcium, iron, lime, bacteria, etc.), the resulting humidification doesn't pollute your indoor air. Instead, your home is freer from these contaminants, creating a healthier, more comfortable environment for you and your family.

## How To Extend the Life of Your Humidifier

Mineral buildup on the humidifier's heating element is harmful to the unit. Therefore, routine maintenance is vital to the effectiveness and longevity of your humidifier.

The normal service interval will vary from one-to-three months (i.e., one or two cleanings during a typical humidification season, plus a thorough cleaning at the end of the season). The hardness of your water, your humidistat setting, weather conditions, home construction and the number of occupants in the home all affect the amount of time between cleanings. **Due to the complexity of your White-Rodgers ComfortPlus Steam Humidifier, we strongly recommend that you make arrangements with your preferred HVAC or plumbing contractor to clean and service the unit at regular intervals.**

**NOTE:** Some HSP2000 and HSP2600 models are equipped with a White-Rodgers Programmable Automatic Flushing Timer (see below), which can reduce maintenance significantly. Nevertheless, it is wise to check the humidifier for mineral buildup every two months or so during the humidification season, and to contact an HVAC dealer if necessary.

**CAUTIONS:** Do not leave water in the humidifier over the warm-weather months.

If the home is left unattended for an extended period of time (e.g., when you go on vacation), turn the humidistat and the water supply to the humidifier off.

### Keep Your Humidifier Running Cleanly and Efficiently ...with a *Programmable* Flushing Timer from White-Rodgers



#### The Automatic Flushing Timer...

- Provides flow-thru technology for steam- and reservoir-type humidifiers
  - Automatically flushes the humidifier water pan with fresh, clean water every two hours
  - Reduces or eliminates servicing during the humidification season
  - Reduces water usage by up to 98 percent when compared to conventional flow-thru humidifiers
- Installs quickly and easily
  - Adapts to most makes and models of steam- and reservoir-type humidifiers

## FAQs About IAQ

### (Frequently Asked Questions About Indoor Air Quality)

#### Why do I need a humidifier?

More and more homeowners are realizing that, during the winter months, they live in a "sick house". Family members suffer from dry, itchy skin, parched throats and annoying coughs. Furniture creaks, floors moan, the piano slips out of tune and static electricity zaps the cat. In general, everyone feels miserable because they're living in an environment that can be drier than the Sahara Desert!

Proper home humidification reduces static electricity, revitalizes dry skin and soothes scratchy throats. It adds moisture to dry, cracked furniture and wilting houseplants. It protects valuable artwork, antiques and musical instruments. It even saves money on winter heating bills. That's because properly humidified air feels warmer, allowing you to turn your thermostat down a few degrees.

#### Why should I lower my humidistat setting when the outside temperature drops?

This practice may seem illogical at first. After all, you increase the temperature on your thermostat as the weather becomes colder. Why not do the same with your humidistat?

The answer is that the *relative humidity* (RH) must be reduced in extremely cold weather to prevent condensation on windows and interior surfaces. Otherwise, the excess moisture will eventually damage your home.

RH refers to the percentage of water vapor in the air at a specific temperature. Because air expands when heated, the relative humidity decreases unless moisture is added. Conversely, air that is cooled contracts, causing relative humidity to increase until it reaches *dew point*—the temperature at which the air becomes saturated and water condenses (just as it does on a glass of ice water on a warm, humid day).

For recommended humidistat settings, refer to the humidistat instructions contained in your humidifier carton.

#### I just installed a White-Rodgers humidifier in my house. Why don't I feel any difference?

The period of adjustment can take up to three weeks—the time needed for your furniture, woodwork, floor coverings, plaster and houseplants to absorb their natural levels of moisture.

#### Should I run my humidifier during the summer months?

Because, in most areas of the country, summer air is naturally more humid, it is not necessary to humidify your home until colder, drier weather sets in.

If you have questions about your White-Rodgers ComfortPlus Humidifier, or to learn which White-Rodgers IAQ products are right for your home, contact your local heating and air conditioning contractor:



# White ▼ Rodgers

8100 W. Florissant Ave.  
St. Louis, MO 63136-9022  
Web: [www.white-rodgers.com](http://www.white-rodgers.com)