

This Owner's Manual is provided and hosted by [Appliance Factory Parts](http://Appliance Factory Parts).

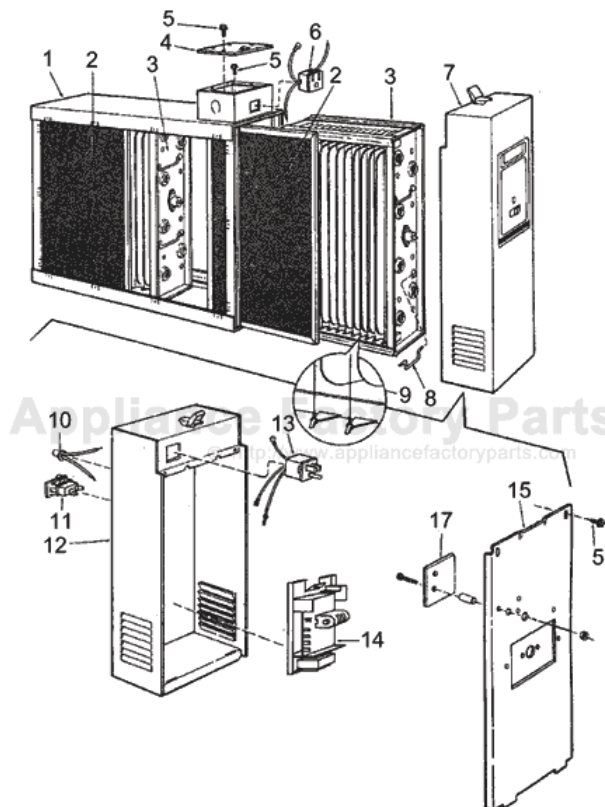

# WHITE RODGERS SST1600-100 Owner's Manual

[Shop genuine replacement parts for WHITE RODGERS  
SST1600-100](#)



[Find Your WHITE RODGERS Air Cleaner Parts - Select From 61 Models](#)

----- Manual continues below -----

White  
Rodgers

# Comfort plus™

## Electronic Air Cleaner

Model Number

# SST

SST1000

SST1400

SST1600

SST2000

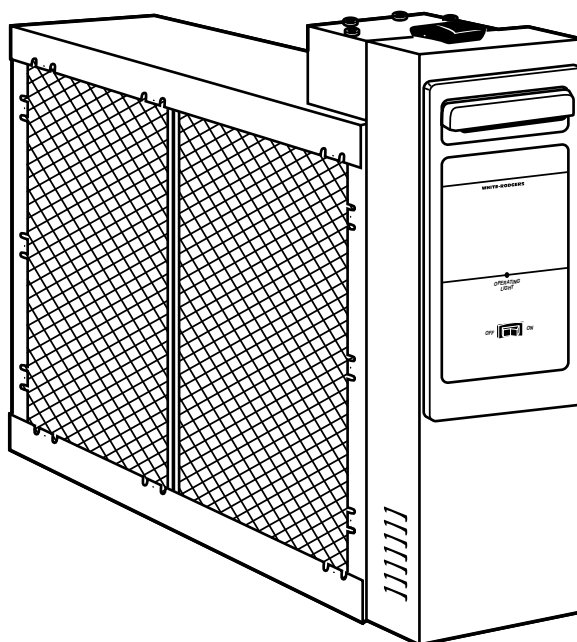

### OWNER'S MANUAL

- Installation
- Operation
- Basic SST Service Guide
- Technical Repair Guide
- Repair Parts

Please read and familiarize yourself with the contents of this manual before installing, operating or performing maintenance on the unit.

# RULES FOR SAFE INSTALLATION AND OPERATION

Please read instructions before installing and using the Electronic Air Cleaner. This will help you obtain the full benefit from the Electronic Air Cleaner you have selected.



**⚠ WARNING**

**ELECTROCUTION HAZARD**  
 Shut off power at fuse panel before servicing. Failure to do so could result in serious personal injury or death.

**⚠ WARNING**

Do not attempt installation of this unit unless you are familiar with the necessary tools, equipment, utility connections and potential hazards.

Installation should be performed only by a qualified service provider.

Failure to do so could result in reduced performance of the unit, serious personal injury or death.

**⚠ WARNING**

Installation of this unit must comply with local electric codes or other applicable codes.

Review and understand local codes prior to installation.

Do not use this apparatus in an explosive atmosphere.

Failure to do so could result in serious personal injury or death.

If this unit has an electrical cord, the cord has a grounding type plug with a third (grounding) pin. This plug will fit only into a grounding type power outlet. If the proper type of outlet is not available, contact qualified personnel to install a proper outlet. Do not alter the plug in any way.

**⚠ WARNING**

To reduce the risk of electric shock, The power cord must be connected to an appropriate outlet. Do not alter the plug in any way.

1. Read the Owners Manual and the Rules for Safe Operation carefully. Failure to follow these rules and instructions could cause a malfunction of filter or unsatisfactory service.
2. Follow a regular service and maintenance schedule for efficient operation.
3. Unit must run for one full hour after installation. This will allow the collecting cells to reach peak efficiency.
4. If Air Flow Monitor is required, order F859-0381 kit.



**⚠ CAUTION**

**CABINET AND CELLS MAY CONTAIN SHARP EDGES.**

Use care when servicing unit or handling cells. Failure to do so could result in minor personal injury.

## TABLE OF CONTENTS

Rules for Safe Installation and Operation .....	2
How the Air Cleaner Works .....	3
Construction of the Air Cleaner .....	3
Preinstallation .....	4
Installation .....	6
Wiring Instructions .....	7
Operation .....	8
Maintenance and Washing .....	8
Specifications .....	9
Basic SST Service Guide .....	10
Technical Repair Guide .....	11
Air Cleaner Retrofit (Upgrade) Kit Installation ....	13
Repair Parts .....	14
Wash Reminder .....	16

## DID YOU GET THE RIGHT SIZE AIR CLEANER

**Model SST1000** is designed for heating or cooling blowers delivering 600 to 1200 cubic feet of air per minute (cfm.)

**Model SST1400** is designed for heating or cooling blowers delivering 1000 to 1600 cfm.

**Model SST1600** is designed for heating or cooling blowers delivering 1000 to 2000 cfm.

**Model SST2000** is designed for heating or cooling blowers delivering 1600 to 2200 cfm.

See specifications on page 9.

## BASIC TOOLS REQUIRED

- Tin Snip
- Screwdriver
- Rule or Tape Measure
- Drill

# HOW THE AIR CLEANER WORKS

Dirt particles flowing through the ducts (Figure 1) first enters the pre-filters (A) where large particles (hair, lint, etc.) are trapped. Smaller particles (smoke, dust, pollen, etc.) pass through these pre-filters and enter the ionizing section (B). Here each tiny particle receives a positive electrical charge. These charged particles then enter the collecting section (C). This section consists of a series of aluminum plates which are alternately charged negative and positive.

The positive charge of the particles cause them to be repelled by the positive plates and attracted to the negative plates where they are collected . . . just as a magnet attracts iron filings.

Clean-filtered air re-enters the supply duct system.

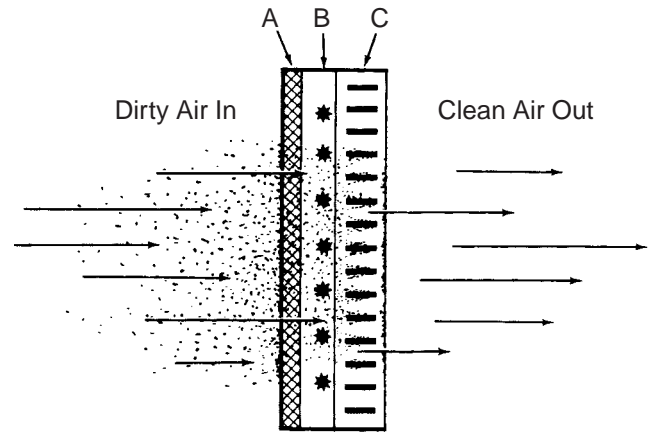

Figure 1

## White Dust (Lint)

An Electronic Air Cleaner is designed to collect two major types of contaminants: ① Irritants (Pollens, Spores, Molds, Bacteria, etc.) and ② Black Soiling Contaminants (Dirt and Smoke particles).

The residue on the collecting plates of an electronic air cleaner is black, indicating it is removing dirt from the air stream. After installing an air cleaner you may notice white dust (typically, long linty particles or fibers – from carpets, cotton materials or drapery fabrics). This material is not collected by the air cleaner because it does not contain the irritants or soiling contaminants listed above or settles out of the air before reaching the air cleaner. The presence of white dust does not indicate an air cleaner requires service.

## Carbon (Charcoal) Filters

Odors are gas molecules, not particles. They cannot be removed by an Electronic Air Cleaner or by any other filtration media designed to remove airborne particles. However, some gases can be absorbed by an activated carbon filter or diluted with fresh outdoor air. When odors are present, the addition of charcoal filters will neutralize odors, such as cooking odors, pet odors, cigar and cigarette odors, ozone, etc. Optional charcoal filters are available for your Air Cleaner. Refer to the parts list for the charcoal filter part number for your Air Cleaner. Charcoal filters require replacement. They cannot be washed. While there is no rule of thumb for how often they should be changed, you can use your best judgement based on the odors you perceive in your environment.

# CONSTRUCTION OF THE AIR CLEANER

Not only is your air cleaner easy to install, it is also easy to operate and maintain. Its basic components, and their functions, are as follows: (See Figure 2)

**Cabinet** - mounts to existing duct work and houses the collecting cells and pre-filters.

**Collecting Cells** - are made in two sections and perform the actual collecting of dust, dirt, and other impurities from the air. They contain the ionizing and collection sections described above.

Each cell must be installed with the ionizing wires on the air entering side. Each cell must be oriented with the handles and contact button (Figure 2) toward the operator.

**Pre-filters** - are in two sections which are interchangeable. They serve as a pre-filter to trap large particles such as hair and lint before they can enter the cell sections.

**Power Pack**- contains operating and power on lights as well as the solid state components that convert the 120 volt power supply to the high-voltage, direct current required for the collecting cell.

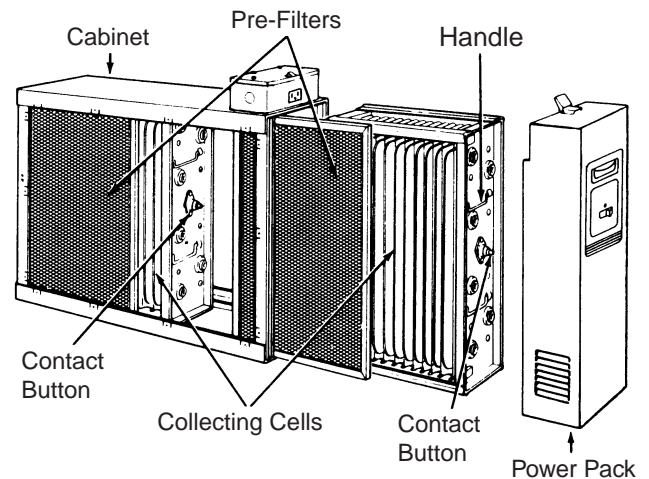

Figure 2

# PREINSTALLATION

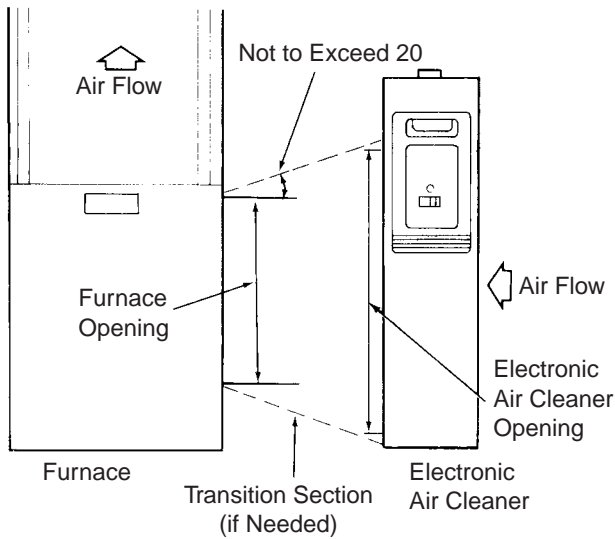

Figure 3

## LOCATING THE AIR FILTER

Your air filter must be mounted in the return air duct of a central forced-air system, on the air entering side of your furnace. (See Figure 3 for example.)

Select a location that meets the following:

1. The face of the cell will be at a right angle to the air stream.
2. Allow the following clearances to permit removal of cells and pre-filters: (See Figures 4 and 5)  
 Model SST1000 - 14 inches  
 Model SST1400 - 15 inches  
 Model SST1600 - 14 inches  
 Model SST2000 - 15 inches  
 For complete dimension data refer to Figure 5.
3. The air filter is not to be placed in the discharge of either the heating or cooling unit.
4. **IMPORTANT:** If atomizing spray type humidifier is used, it must be installed downstream from the air filter.
5. If the air cleaner has a power cord installed, unit must be located close enough to the outlet so connection can be made without the use of an extension cord.

If your furnace duct system has a pre-installed boot, discard front cover of boot and slide the air cleaner component inside the boot. For installation of Air Cleaner Retrofit (ACR) kits, see page 13.

If furnace opening cannot be enlarged to required size, a transition sheet metal section must be used. Transition must be planned for each job. Reduction should not be more than 4 inches per linear foot, approximately 20 angular degrees (Figure 3).

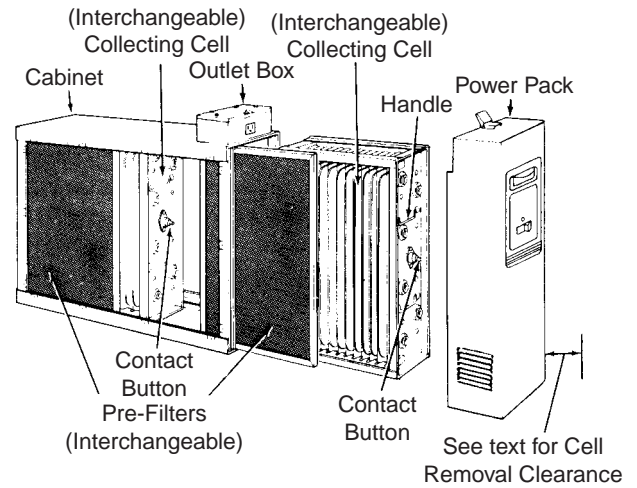
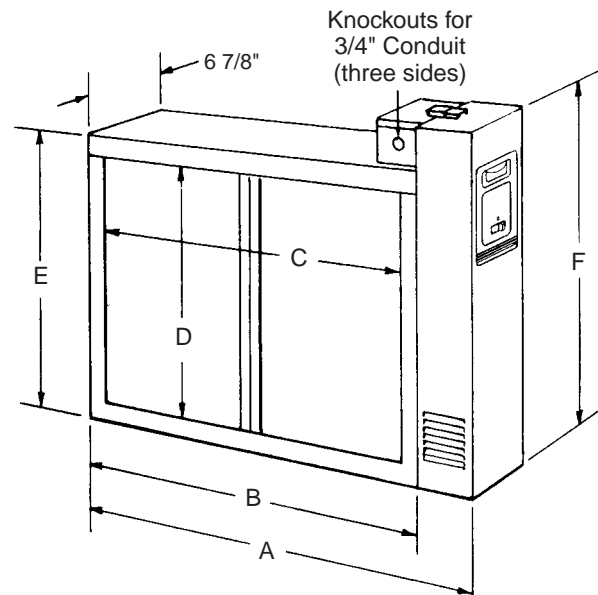

Figure 4



MODEL NO.	A	B	C	D	E	F
SST1000	24 3/4	21 5/16	18 5/8	13 9/16	16 7/16	19 1/16
SST1400	29 11/16	26 1/4	23 5/8	13 9/16	16 7/16	19 1/16
SST1600	25 1/2	21 5/16	18 5/8	17 3/4	20 5/8	23 3/8
SST2000	29 11/16	26 1/4	23 5/8	17 3/4	20 5/8	23 3/8

Figure 5

## DIRECTION OF AIR FLOW THROUGH THE AIR CLEANER

Your air cleaner is shipped from the factory with air flow from left-to-right. If this air flow is suitable for the installation, no further changes need to be made (Figure 4). For right-to-left air flow, remove both pre-filter and cell sections. Turn cells upside down (with the same end facing the cabinet opening). This will locate the ionizing wires at the right, and both contact buttons and cell handles will be facing the power door. Air flow direction must agree with arrow embossed on end of collecting cells.

After installing the cell sections, install pre-filters in cabinet tracks on the right. This will again place the pre-filters on the air entering side (on the same side as ionizing wires).

## TYPICAL MOUNTING POSITIONS

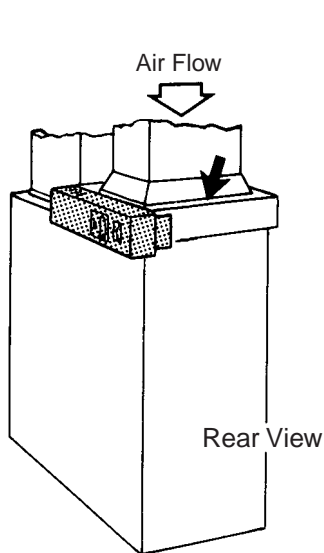

Figure 6

### BASEMENT FURNACE (LOWBOY) (Figure 6)

Cleaner is mounted horizontally in return plenum, just above furnace.

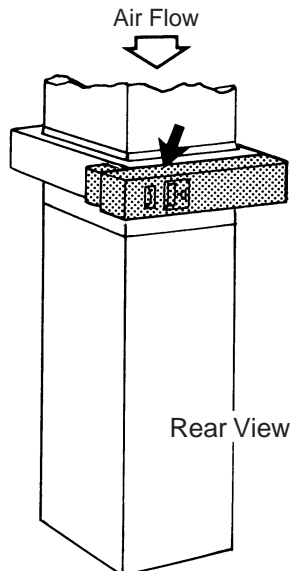

Figure 7

### COUNTERFLOW FURNACE (Figure 7)

Cleaner is mounted horizontally in return duct or plenum, just above furnace.

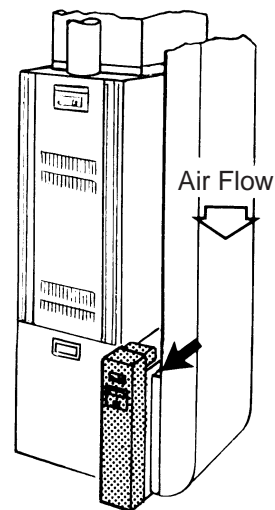

Figure 8

### HIGHBOY FURNACE (Figure 8)

Side installation. Cleaner is mounted vertically, where return air enters side inlet of furnace.

### HIGHBOY FURNACE (Figure 9)

Installation beneath furnace. Cleaner mounts horizontally, where return air enters from below. Raise furnace and install beneath base.

After attaching the air cleaner cabinet to the furnace, carefully slide or lift and place the furnace into position. Do not "walk" the furnace into position.

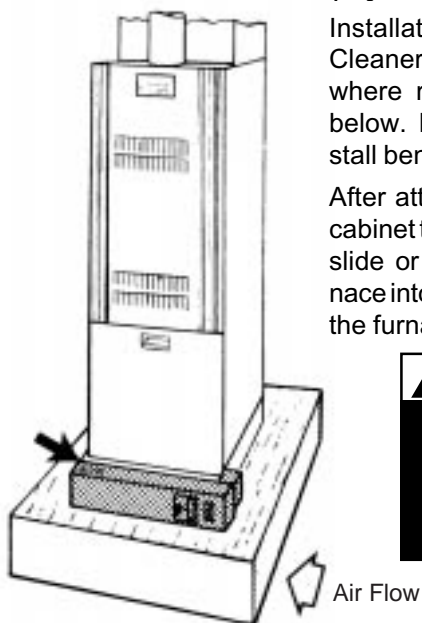

Figure 9

**CAUTION**  
Walking furnace into position could cause damage to the air cleaner cabinet.

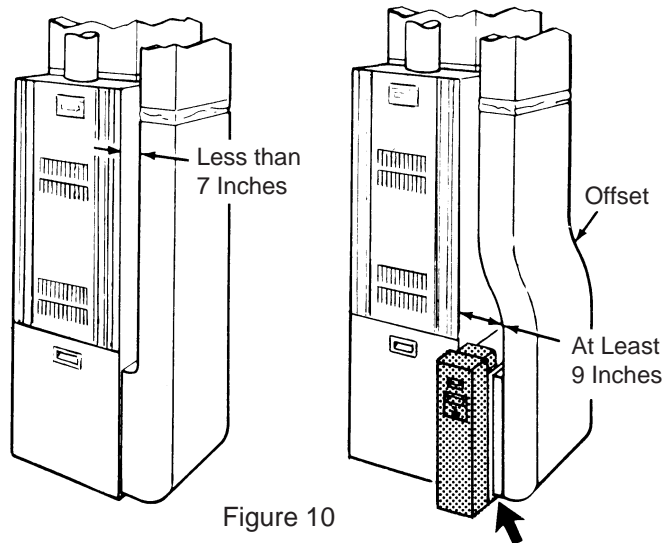

Figure 10

### OFFSET INSTALLATION (Figure 10)

Typical use of duct offset to match air filter opening. If duct connection to furnace allows less than nine inches for mounting the air cleaner, shorten the lateral trunk, or attach an offset fitting to the elbow.

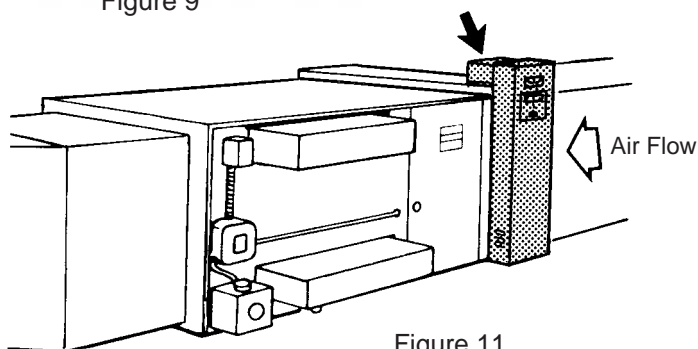

Figure 11

### HORIZONTAL FURNACE (Figure 11)

Cleaner is mounted vertically in the return duct near furnace.

# INSTALLATION

## REMOVE OLD FILTER AND DISCARD (Figure 12)

NOTE: This filter may be mounted in the furnace compartment.

## CLEAN BLOWER COMPARTMENT

It is suggested that the furnace blower compartment, blower and blower housing be cleaned to ensure clean air circulation.

## INSTALLATION

The following is a typical installation of the air cleaner on a "Highboy" furnace (Figure 8).

1. Place the air filter cleaner on the floor. Stand it upright with the power door facing you (Figure 4). If a horizontal installation is being planned, lay the cleaner on its side, this will help you to visualize the relative location of all parts.

Allow ample space for wiring and servicing the power supply box (Figure 13).

2. Release the latch, remove the power pack (by grasping handle and pulling power pack away from cabinet) and set it aside. Remove the collecting cells and pre-filters. Set pre-filters and cells aside in a safe location until the cabinet is installed.

3. Set the cabinet next to the furnace. If necessary, enlarge the opening in the furnace (if possible) to match the opening in the cabinet.

If the furnace opening cannot be enlarged, a transition fitting should be used. (Figure 3).

The cabinet can be attached directly (Figure 13), or a starting collar can first be fitted to the furnace inlet. A butt or slip joint can be used.

Securely attach the cabinet to furnace inlet, using at least two of the mounting holes on each side of the cabinet.

4. Using butt joint, attach duct work (normally an elbow) to the upstream side of air cleaner cabinet. (Note the use of the sheet metal turning vanes inside the elbow to improve air distribution over the face of the cells.) (Figure 14)

**NOTE:** An optional method of attaching duct work to the cabinet is to modify the cabinet (Figure 15) by bending the tabs outward at a 90° angle and attaching duct work to tabs.

### Transition Fittings

If the air duct does not fit the cabinet opening, a transition fitting should be used. Gradual transitions are preferred for greatest efficiency. Not more than four inches per linear foot (approximately 20° angle) should be allowed (Figure 3).

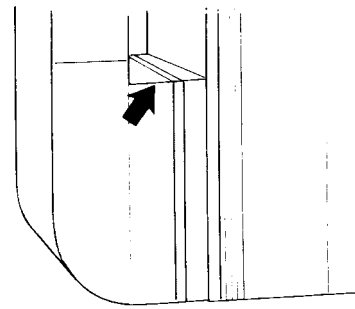

Figure 12

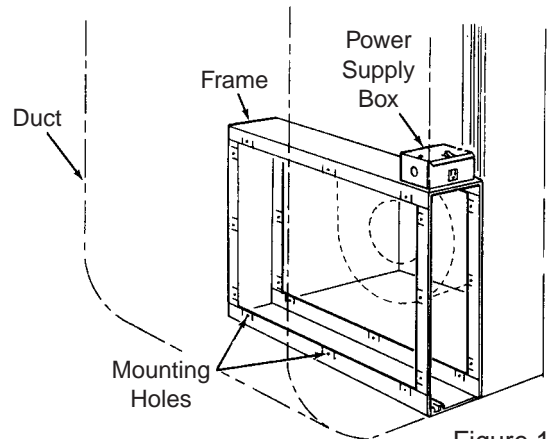

Figure 13

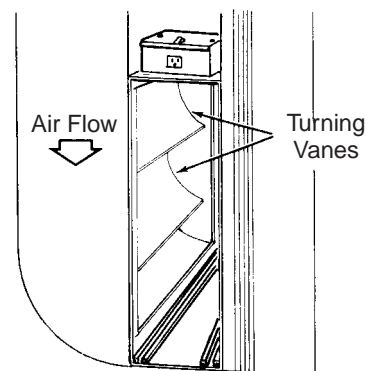

Figure 14

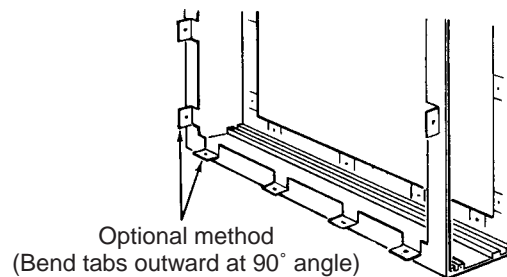

Figure 15

5. Connect the vertical duct section to the elbow. Wedge a wood block between floor and elbow for support (Figure 16).
6. Seal all joints in the return air system downstream from the air cleaner with duct tape to prevent dust from entering the air stream. Tape is usually applied on the outside of ducts, but may also be applied on the inside, or both.

# WIRING INSTRUCTIONS

7. With the cabinet installed, the air cleaner can now be wired to electrical input source.

## ⚠ WARNING

Installation of this unit must comply with local electric codes or other applicable codes.

Review and understand local codes prior to installation.

Failure to do so could result in serious personal injury or death.

8. An air cleaner unit with no air flow monitor requires electrical wiring through the furnace controls. Connect wiring to the furnace control terminals (EAC-H) for power, (EAC-N) for neutral and connect metal frame of EAC to ground.

If the air cleaner unit has an air flow monitor, it must be connected to 120 VAC 60 Hz. A 20 amp circuit is more than adequate. If an air flow monitor is not installed but is required for operation, order Air Flow Kit F859-0381. If a power cord is required, order F97-0019.

9. Remove junction box cover and install the required bushing into the 3/4 in. Knock out. With the supply voltage turned off, route three (3) wires into junction box for connections. (See Fig. 17.)

Insure all wires are clamped, wire connectors properly installed and grommets used to prevent wire abrasion.

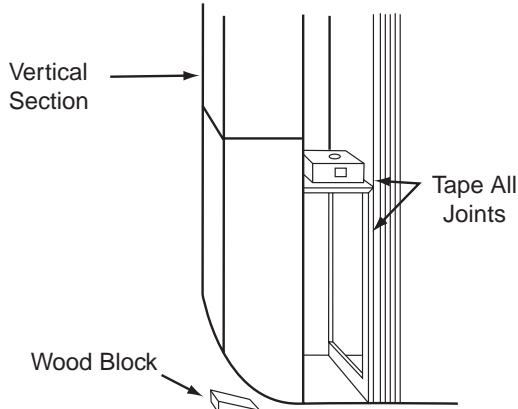

Figure 16

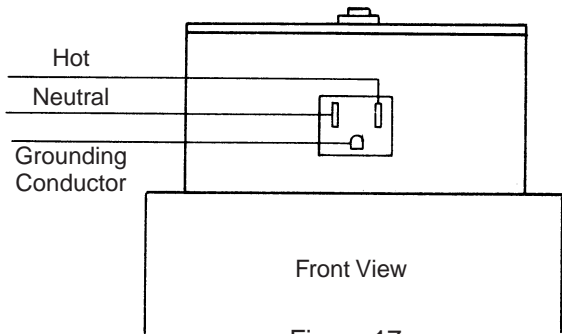

Figure 17

10. If this unit has an electrical cord, the cord has a grounding type plug with a third (grounding) pin. This plug will fit only into a grounding type power outlet. If the proper type of outlet is not available, contact qualified personnel to install a proper outlet. Do not alter the plug in any way.

## ⚠ WARNING

To reduce the risk of electric shock, The power cord must be connected to an appropriate outlet. Do not alter the plug in any way.

11. **With the cabinet Installed**, reinstall pre-filter(s) and collecting cell(s) (Figure 18).

NOTE: The contact button and handles on the cell must be facing you and ionizing wires must be on the air intake side.

12. Install the power pack as follows:

Engage the lip on lower inside edge of power pack in the flange on cabinet and carefully close the power pack, making sure that the electrical connector prongs on the power pack enter the slots in the socket on cabinet. When the power pack is fully in place, engage the latch and snap it closed.

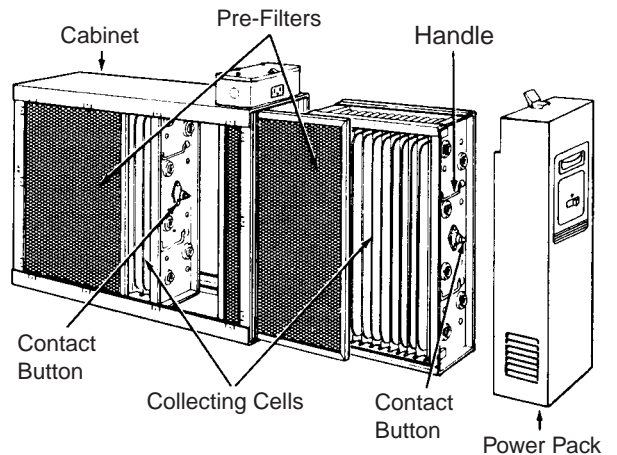

Figure 18

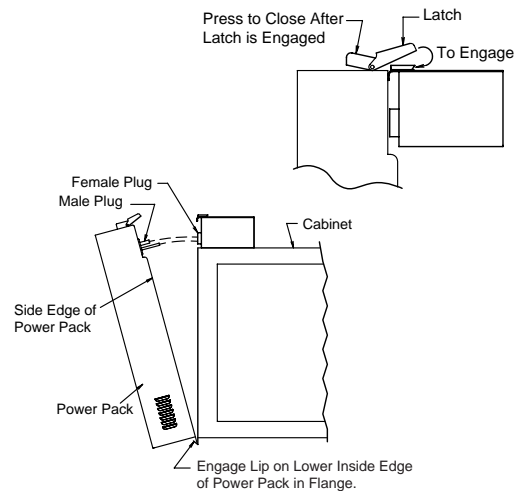

Figure 19 Installing Power Pack

## OPERATION

1. With the 120 VAC power turned on at the circuit breaker for the furnace, push the air cleaner ON-OFF switch to the "ON" position (Figure 20).
2. With the furnace blower running, the air cleaner will be operating. An arcing or "snapping" sound may be heard. This will occur occasionally, however the unit is operating properly.
3. With the furnace blower running, the Operating Light should be ON. If the Operating Light is not ON this signifies that the cells need washing, or that trouble exists in the unit.

If, after washing the cells, the Operating Light stays off, the cell could be wet, improperly placed in the cabinet or may need servicing.

**NOTE:** An occasional flicker of the light accompanied by harmless sparking or snapping noise may occur. This is caused by trapping large particles of dirt. If arcing is continuous, the cells should be washed or checked for service problems see Basic SST Service Guide.

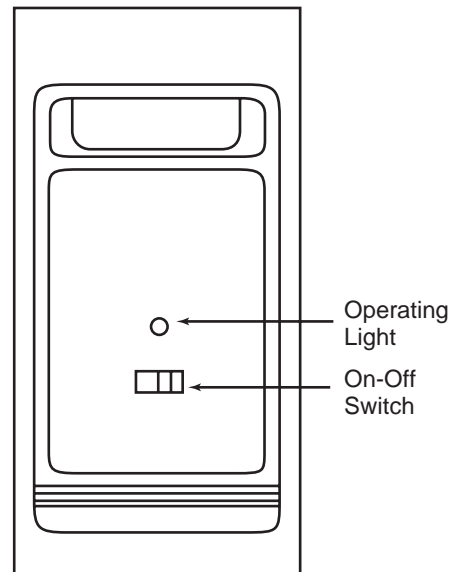



Figure 20

## MAINTENANCE AND WASHING

	<b>CAUTION</b>
	<b>CABINET AND CELLS MAY CONTAIN SHARP EDGES.</b>
	<b>Use care when servicing unit or handling cells.</b>

**Failure to do so could result in minor personal injury.**

For maximum efficiency your air cleaner cell(s) and pre-filter(s) should be inspected once a month and cleaned when necessary. Cleaning will usually be required every one to three months, depending upon the particular household circumstances. When cleaning is required the following procedure should be used:

### CLEANING THE CELLS

1. Turn the air moving system "OFF."
2. Push the ON-OFF switch on the power pack to the "OFF" position (Figure 20). Wait 15 seconds and both the power pack and the collecting cell(s) will be automatically discharged.
3. Release the latch on top of power pack and pull the power pack straight away from cabinet at the top. Then lift pack out of ledge at bottom edge of cabinet. Set power pack aside.

4. Remove the cell(s) and pre-filter(s) from cabinet. Using a solution of warm water and low sudsing detergent, soak cell(s) and pre-filter(s) for 20 to 30 minutes.

**NOTE:** Ionizing wires may become coated causing loss of cleaning ability by the collecting cell. Using a damp cloth, wipe each ionizing wire, exercising care not to damage them.

5. Remove the cell(s) and pre-filter(s) from solution and rinse thoroughly with clean water.
6. Allow cell(s) and pre-filter(s) to drip dry for a **minimum of 2 hours**. Cell(s) and pre-filter(s) may be tipped at a slight angle to expedite the drip-dry process.
7. Reinstall the cell(s) and pre-filter(s) in the cabinet.
8. Replace the power pack. Turn furnace fan on. After 30 minutes push ON-OFF switch on the power pack to the "ON" position.

A moderate amount of arcing or "snapping" may occur at this time, which will indicate that the cell(s) are still damp. If the noise is objectionable, push the ON-OFF switch to the "OFF" position and allow additional time for cell(s) and pre-filter(s) to dry. In some cases the Operating Light will remain OFF during this initial activation of the air cleaner, and this would indicate that the cell(s) are not completely dry. The Operating Light should remain ON while the furnace fan is running once the drying is complete.

## REPLACING AN IONIZING WIRE

If an ionizing wire should break, it can be replaced as follows:

1. Remove all pieces of broken wire. Make sure supports at each end are in good condition and not bent out of shape.
2. Hook the new wire onto the support at one end.
3. Hold your finger against the support at the other end (Figure 21) and hold the ionizing wire between thumb and forefinger as shown or use needle nose pliers. Press inward on spring support. Hook end of wire over small tab at end of support and release. Make sure wire is securely anchored at each end.

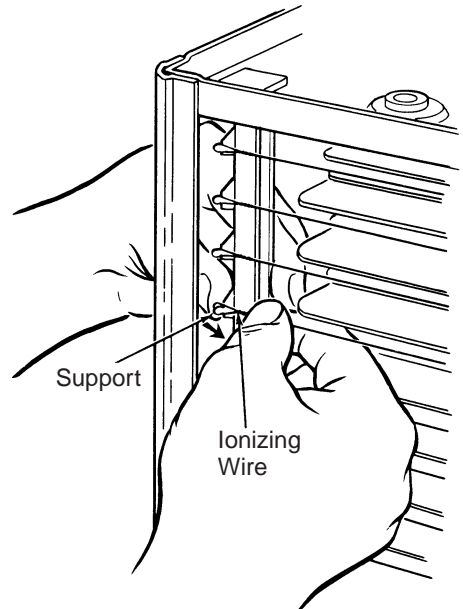

Figure 21

## SPECIFICATIONS

SPECIFICATIONS	SST1000	SST1400	SST1600	SST2000
Rated Capacity	600 - 1200 cfm	1000 - 1600 cfm	1000 - 2000 cfm	1600 - 2200 cfm
Max. Pressure Drop	.08 in. W.G.	.08 in. W.G.	.12 in. W.G.	.09 in. W.G.
Cell Weight	(2) 7 lbs. each	(2) 9 lbs. each	(2) 9 lbs. each	(2) 9 lbs. each
Power Pack Weight	9 lbs.	9 lbs.	10 lbs.	10 lbs.
Unit Weight	35 lbs.	42 lbs.	38 lbs.	45 lbs.
Power Consumption	40 Watts (Max)	40 Watts (Max)	40 Watts (Max)	40 Watts (Max)
Electrical Input	120 VAC 60 hz.	120 VAC 60 hz.	120 VAC 60 hz.	120 VAC 60 hz.
Electrical Output @ 6450 VDC (nom)	1.0 Ma	1.2 Ma	1.5 Ma	1.7 Ma
Max. Ozone Output	.05 ppm	.05 ppm	.05 ppm	.05 ppm
Temperature Rating	40 F to 125 F	40 F to 125 F	40 F to 125 F	40 F to 125 F

# BASIC SST SERVICE GUIDE

This guide will cover most homeowner complaints. If, after checking the items listed, the unit still fails to operate properly, contact the nearest Authorized Service Center.

SERVICE INDICATION	SERVICE CHECKS
ON/OFF switch "ON" Blower ON Operating Light ON	<b>Unit functioning Normally</b>
ON/OFF switch "ON" Blower ON Operating Light OFF	<ol style="list-style-type: none"> <li><b>1. Power is not being supplied to air cleaner.</b> <ol style="list-style-type: none"> <li>A. Check fuse or circuit breaker.</li> <li>B. Ensure power pack is properly installed and latched.</li> </ol> </li> <li><b>2. Collecting cell shorted - Turn power Off - Remove power pack - Remove collecting cells - Replace power pack - Restore power (ensure blower is operating).</b> <ol style="list-style-type: none"> <li>A. If Operating Light comes ON check cells for bent plates, loose ionizing wire(s) or cracked insulator(s).</li> <li>B. If Operating Light remains OFF, malfunction is in the power pack. (See power supply Checkout Procedure).</li> </ol> </li> </ol>
ON/OFF Switch "ON" Blower OFF Operating Light ON	<ol style="list-style-type: none"> <li><b>1. Air flow sensor contaminated/misaligned</b> <ol style="list-style-type: none"> <li>A. Remove power pack and clear contamination inside black bushing around the small sensor element.</li> <li>B. Ensure small sensor element is centered in bushing.</li> </ol> </li> <li><b>2. Air sensor left in bypassed condition after servicing.**</b></li> <li><b>3. Faulty air flow sensor panel.</b></li> </ol>
Excessive arcing during normal operation - Operating Light may blink	<ol style="list-style-type: none"> <li><b>1. Wet collecting cell.</b> <ol style="list-style-type: none"> <li>A. Allow cell(s) to dry after cleaning before applying power.</li> </ol> </li> <li><b>2. Damaged collecting cell(s).</b> <ol style="list-style-type: none"> <li>A. Remove cell(s) and inspect for bent plates, loose ionizing wire(s), cracked insulator(s), etc.</li> </ol> </li> <li><b>3. Collecting cells dirty.</b> <ol style="list-style-type: none"> <li>A. Clean cells as instructed in this manual.</li> </ol> </li> <li><b>4. Faulty power supply (see power supply checkout procedure)</b></li> </ol>
<p><b>**NOTE:</b> Your air cleaner may be equipped with an air flow sensor (switch) which turns the unit ON and OFF in response to the system blower. It may have been "wired out" during a service check and inadvertently left in this condition.</p>	

# TECHNICAL REPAIR GUIDE

## ⚠ WARNING

**Do not attempt repair of this unit unless you are familiar with the necessary tools, equipment, utility connections and potential hazards.**

**Repair should be performed only by a qualified service provider.**

**Failure to do so could result in reduced performance of the unit, serious personal injury or death.**

This guide contains service checks to assist service personnel in locating and correcting any malfunction that might occur to render the air cleaner ineffective or inoperative. The air cleaner has been designed with replaceable components, such as the high-voltage power supply and air flow switch. This allows the serviceman to replace a faulty component rather than attempt repairs of such components in the field.

All voltage measurements indicated can be made with a high voltage D.C. probe and a general purpose volt ohm meter. For example: Simpson 260 or equivalent.

For test purposes, the air flow switch may be "wired out" of the system. This will eliminate the need for air flow across the sensing thermistor to energize the power supply (see Fig 23).

NOTE: All tests to be performed with the Ozone Reduction Jumper intact.

NOTE: When servicing the power pack components, all wiring must be routed to factory specifications.

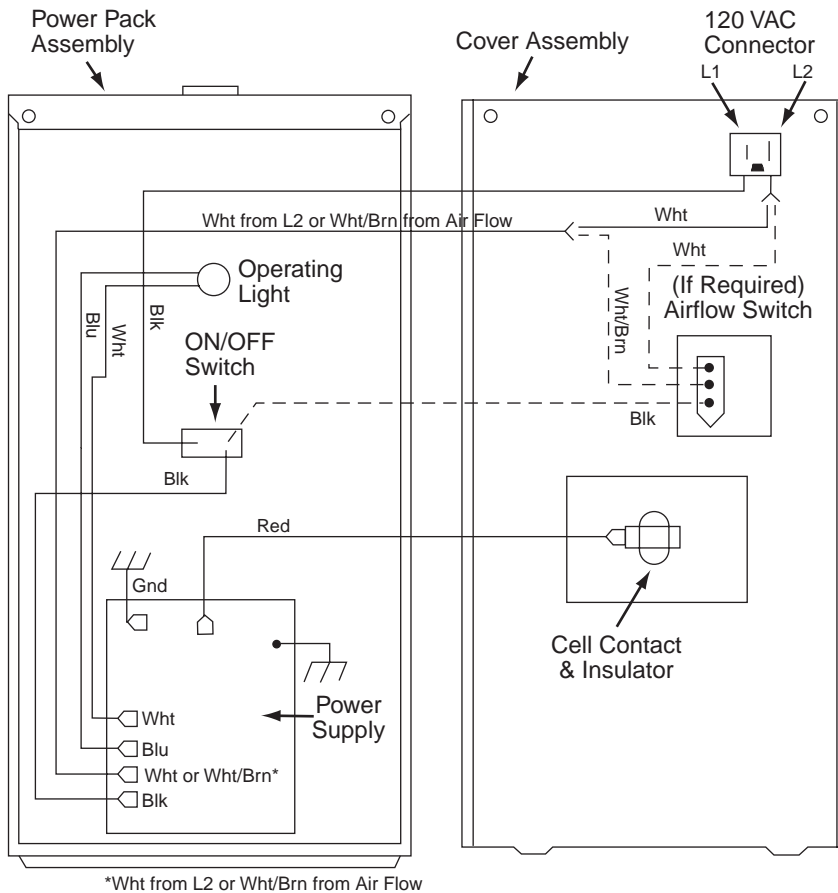

### Power Supply Specifications

The solid-state power supply is not designed for individual component part replacement and must be replaced as a complete "snap-in" unit.

Input voltage: 120 VAC 60 Hz.  
Output to light: 1.5 to 2.5 VDC  
H.V. Output: 6450 VDC (nom)

### Collecting Cell Specifications

1000 cfm - 1.0 Ma @ 6450VDC  
1400 cfm - 1.2 Ma @ 6450 VDC  
1600 cfm - 1.5 Ma @ 6450 VDC  
2000 cfm - 1.7 Ma @ 6450 VDC

Figure 22

## POWER SUPPLY CHECKOUT PROCEDURE

1. Turn power switch to the "OFF" position and remove the power pack from cabinet.
2. If air flow switch is installed, locate air flow switch and remove power pack cover. If air flow switch is not installed, go to step 4.
3. Disconnect the three-pin plastic connector and jumper the two female pins (white wire to white-brown wire) as shown in Fig. 23.

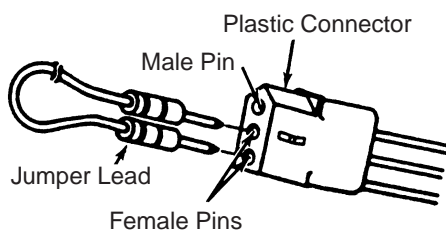

Method of jumping lead wires of connector plug from air flow switch.

Figure 23

4. Place power pack on a well insulated workbench. Connect meter negative (-) lead to the sheet metal chassis and the high voltage probe to high voltage contact on back cover of power pack. Connect AC power to power pack using an extension cord and turn power switch to the "ON" position. **Keep hands and tools away from high voltage contact.**
5. If Operating Light comes ON and output voltage is between 6100 and 6800 VDC, power supply is good.
6. If voltage is good but Operating Light does not come on, replace Operating Light.

## CELL TEST

1. Place collecting cell on a well insulated workbench with the cell contact button pointing upward.
2. Select a power pack (with air flow switch bypassed and ozone reduction jumper intact) that reads between 6100 and 6800 VDC at the cell contact with no cell attached.
3. Place power pack on top of collecting cell ensuring that there is proper contact between the cell contact on the power pack contact.

4. Using a standard extension cord, apply 120 VAC to power pack. Turn power switch to "ON" position.
5. Connect meter negative (-) lead to metal frame of collecting cell. Use high voltage probe to measure voltage at collecting cell ionizer or cell plates. Voltage should be 6100 to 6800 VDC.  
**NOTE:** A new "out-of-box" cell may cause the voltage to be lower than normal for a short period of time. To obtain a more accurate measurement, "age" the cell by applying high voltage to the cell for 15 to 30 minutes.
6. If voltage is below 6100 VDC, check cell for foreign objects, bowed/bent/loose plates, broken ionizing wires or cracked insulators. Wash cells if required. If Operating Light remains OFF, replace collecting cell.

## AIR FLOW MONITOR TEST

1. Connect a multimeter set to read 120 VAC to power supply terminals marked "LINE."
2. Connect 120 VAC to power pack plug, turn power switch "ON."
3. Blow on thermistor at air flow monitor. 120 VAC should appear at multimeter. Stop blowing and voltage should disappear in 10 - 15 seconds.
4. If voltage did not appear (Step 3), disconnect power to power pack. Locate air flow switch and remove power pack cover. Disconnect the three-pin plastic connector. Jumper the two female pins (white wire to white-brown wire) as shown in Fig. 23. Reconnect power to power pack. Turn power switch "ON."
  - A. If 120 VAC appears at multimeter, replace air flow monitor.
  - B. If 120 VAC does not appear on multimeter, problem is other than air flow monitor. Recheck all primary wiring.

**NOTE:** The air flow monitor is designed to operate in the temperature range of 65° to 120° F. Operation outside this range is not recommended.

## OZONE REDUCTION

All electronic air cleaners typically produce a small amount of ozone that is within established limits. Some customers may notice an odor especially at high altitudes or low air flow rates.

This power supply has a “hairpin” shaped jumper wire labeled W1 (see Fig 24) that can be cut and separated in case of such complaints. This will cause the power supply to limit the maximum operating power to a lower level.

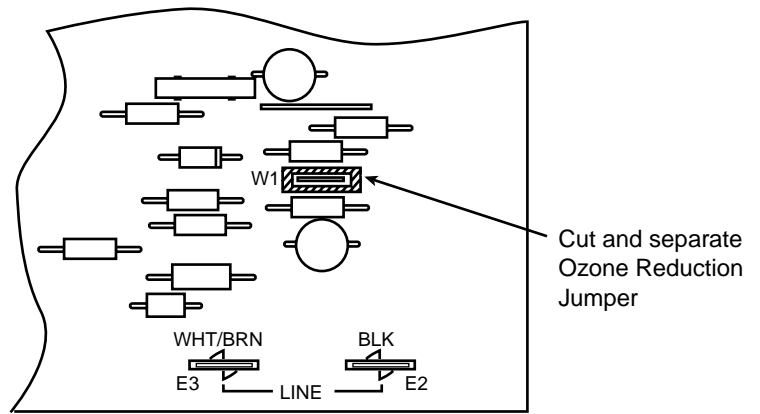

Ozone Reduction Jumper

Figure 24

---

## ELECTRONIC AIR CLEANER RETROFIT (ACR) KITS

### INSTALLATION

1. Remove the two pre-filters from the package and insert into cabinet tracks opposite the furnace. These will be used to catch the larger particles that are in the air stream before entering the collecting cell.
2. Insert the two collecting cells into the cabinet behind the pre-filters. Be sure ionizing wires are directly behind the pre-filters so the particles can be charged as soon as the air leaves the pre-filters.
3. Remove cover plate on the power supply junction box and remove the knockout needed to bring the wire to the female receptacle.
4. Position receptacle with ground in the down position as shown in Fig 17 (page 7) and pull wires through the receptacle locator on the junction box. Snap the receptacle into the hole until secure.
5. Connect ground wire from receptacle and ground wire in kit to cabinet with rivet and washer as follows:
  - a) Place washer on rivet
  - b) Place terminal from ground wire on rivet
  - c) Place terminal from receptacle ground wire on rivet
  - d) Insert rivet in hole in junction box and secure.

### WIRING

5. For wiring installation (see page 7) and follow all wiring instructions 7, 8 and 9.
6. Install the power pack (see page 7) instruction 11.
7. For operation (see page 8 – Operation).

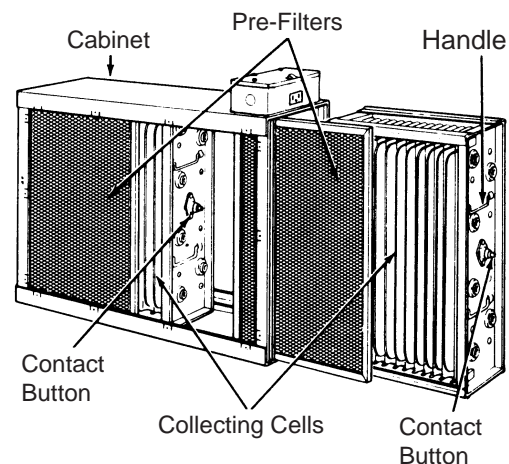

# REPAIR PARTS

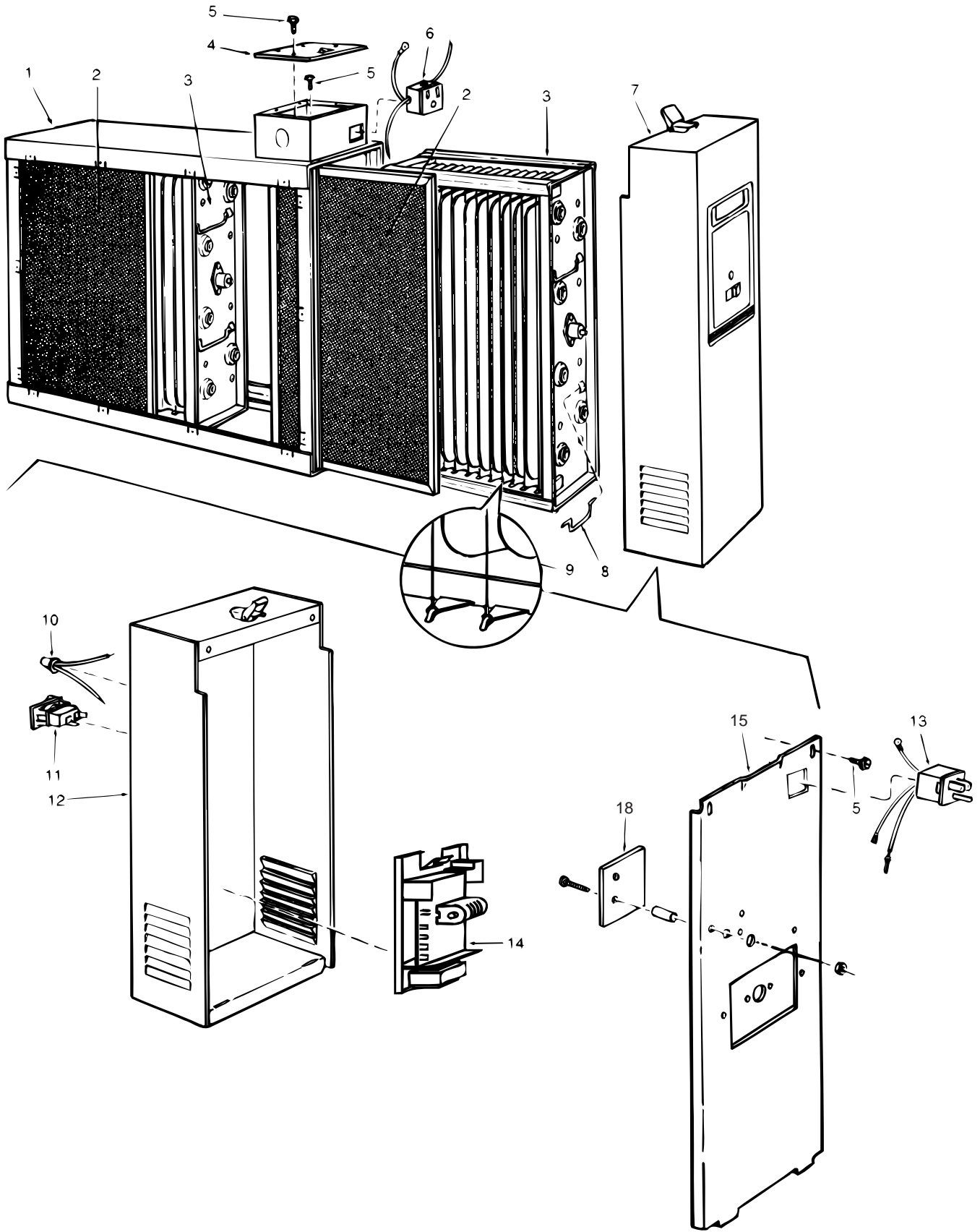

# REPAIR PARTS

## PARTS LIST FOR ELECTRONIC AIR CLEANERS

When ordering repair parts, always give the following information as shown in this list.

1. The PART NUMBER
2. The PART DESCRIPTION
3. The MODEL NUMBER
4. The NAME OF ITEM - Electronic Air Cleaner.

**Always order by "PART NUMBER" . . . Not by "ITEM NUMBER"**

ITEM NO.	DESCRIPTION	PART NUMBER			
		SST1000	SST1400	SST1600	SST2000
1	Cabinet	N/A	N/A	N/A	N/A
2	Pre-Filter	•F825-0431	• F825-0432	• F825-0337	•F825-0338
3	Collecting Cell	•F811-0398	• F811-0397	• F811-0321	•F811-0319
4	Junction Box Cover	F838-0072	F838-0072	F838-0072	F838-0072
5	* Screw #6 x 3/8	-----	-----	-----	-----
6	Connector, Female	F818-0053	F818-0053	F818-0053	F818-0053
7	Power Pack Assembly without Air Flow	F858-1021	F858-1022	F858-1023	F858-1024
	Power Pack Assembly with Air Flow	F858-1031	F858-1032	F858-1033	F858-1034
8	Cell Handle	F832-0039	F832-0039	F832-0039	F832-0039
9	Ionizing Wire	F843-0484	F843-0484	F843-0500	F843-0500
10	Light	F844-0130	F844-0130	F844-0130	F844-0130
11	Switch	F876-0202	F876-0202	F876-0202	F876-0202
12	Power Pack, Cabinet Only	N/A	N/A	N/A	N/A
13	Connector, Male	F827-0026	F827-0026	F827-0026	F827-0026
14	Power Supply	F858-1002	F858-1002	F858-1002	F858-1002
15	Cover, Power Pack	F16-8520	F16-8520	F16-8521	F16-8521
16	† Manual	37-6373	37-6373	37-6373	37-6373
17	† Charcoal Filter (with mounting clips)	F825-0466	• F825-0467	• F825-0468	•F825-0469
18	Air Flow Switch (monitor kit)	F859-0381	F859-0381	F859-0381	F859-0381

\* Standard Hardware Item

• Two (2) Required

† Not Shown

