

This Owner's Manual is provided and hosted by [Appliance Factory Parts](#).



CARRIER HUMCCSBP2212 Owner's Manual

[Shop genuine replacement parts for CARRIER
HUMCCSBP2212](#)



[Find Your CARRIER Humidifier Parts - Select From 171 Models](#)

----- Manual continues below -----



HUM Humidifiers

HOMEOWNER'S MANUAL

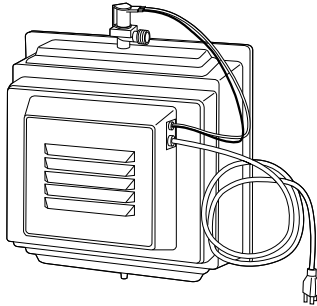

**Model HUMCCLFP1025-A--
Fan-Powered Humidifier**

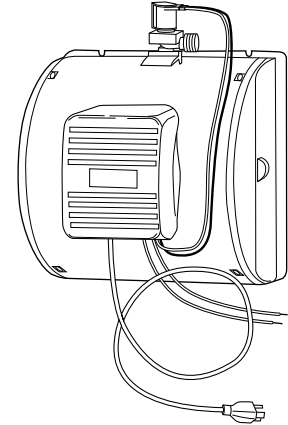

**Model HUMCCSFP1016-A--
Fan-Powered Humidifier**

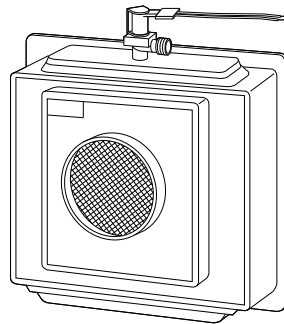

**Model HUMCCLBP2018-A--
Bypass Humidifier**

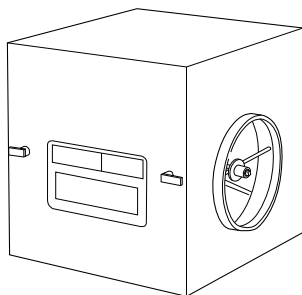

**Model HUMCCWTR2019-A--
Water-Saver Bypass Humidifier**

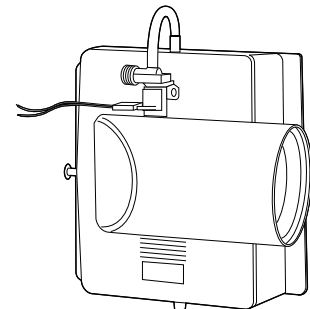

**Model HUMCCSBP2017-A--
Bypass Humidifier**

NOTE TO INSTALLER: *This manual should be left with the equipment user.*

REFRESHING MOISTURE . . . AS NATURE INTENDED

Congratulations on your excellent choice and sound investment in this addition to your home comfort system.

Your humidifier represents both the latest in engineering development and the culmination of many years of experience from one of the most reputable manufacturers of comfort systems.

Your new unit is among the most energy-efficient and reliable home humidifiers available today. To assure its dependability, spend a few minutes now with this booklet. Learn about the operation of your humidifier and the small amount of maintenance it takes to keep it operating at peak efficiency.

With minimal care, your humidifier will provide you and your family with moist, spring-fresh air — from season to season and year to year.

YOUR HOME HUMIDIFIER

YOUR HOME CAN BE DRIER THAN DEATH VALLEY

During the heating season, your home can become uncomfortably dry. This is because cold winter air holds very little moisture. When outdoor air is warmed to average room temperature, its relative humidity falls to even lower levels. Refer to Table 1 for a comparison of the levels of relative humidity for a few sample environments.

Table 1 — Relative Humidity Comparison

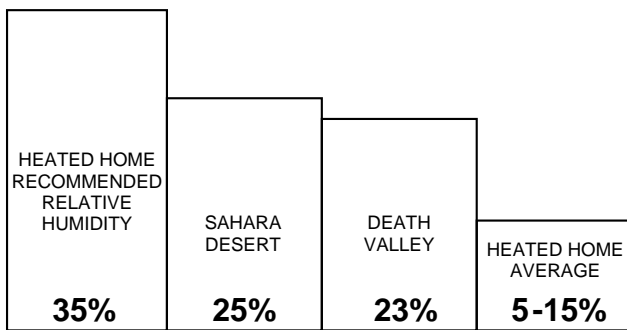

Parched air can cause the wood used in the construction of your house and furnishings to dry, crack, and split. Draperies and upholstery may age prematurely. Annoying static electric shock and cling are more prevalent. Your throat, nasal passages, sinuses, and skin are more susceptible to irritating dryness. You may even have to set the thermostat higher than otherwise necessary — just to feel warm.

MOISTURE MAKES A REFRESHING DIFFERENCE

Proper humidity control can alleviate problems caused by excessive dryness. Furnishings and fabrics take on a more lustrous appearance. Houseplants thrive. Static electricity is significantly reduced in a properly humidified home. Your family will breathe more easily and find relief from the cool, drafty feeling commonly experienced in overly dry homes. The additional moisture supplied by your humidifier may enable you to reduce the temperature setting on your thermostat — without any loss of indoor comfort.

HOW YOUR HUMIDIFIER WORKS

Your humidifier adds water molecules to the air inside your home. Although the rate of humidification is variable, it may exceed one-half gallon of water per hour. That's a healthy drink for a dry household. The typical process of humidification begins when water flows through the humidifier valve and soaks

the large evaporator pad. Hot, dry air from the furnace passes through the pad and absorbs the water. Then, this moisture-laden air is distributed throughout the house via the ductwork. See Fig. 1, 2, and 3.

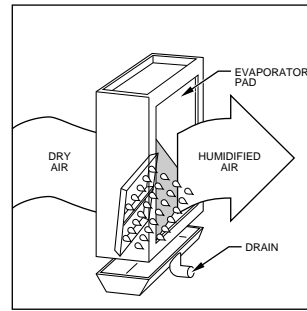

Fig. 1

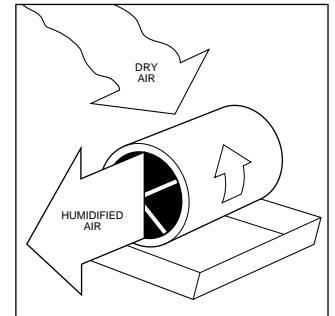

Fig. 2

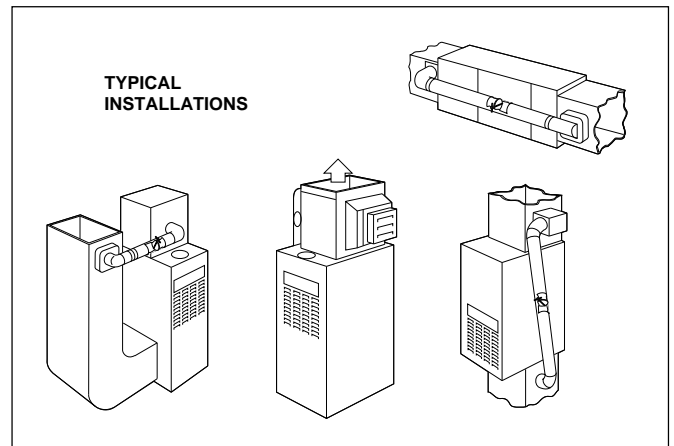

Fig. 3

OPERATING YOUR HUMIDIFIER

Your new humidifier is designed to operate as part of your home heating system. It will perform at maximum efficiency if these recommendations are followed:

- The humidifier is controlled by a humidistat. Adjust the humidistat setting according to the outside temperature. Refer to Table 2 as a general guide. If after several days, the air in your home seems too moist, lower the humidistat setting. Condensation on single-pane windows indicates excessive moisture. If the air is too dry, increase the setting. Dry throat and nasal passages indicate dry air.
- All models come with a humidistat. Continuous blower operation provides for constant humidification. It may also contribute to greater personal comfort because continuous blower operation minimizes temperature differences throughout the home. Furthermore, a system equipped with an electronic air cleaner offers the added benefit of full-time air filtration.

Table 2 — Humidistat Settings

OUTSIDE TEMPERATURE (°F)	RECOMMENDED HUMIDISTAT SETTING (% RELATIVE HUMIDITY)
-20	15
-10	20 (LOW)
-0	25
10	30
20	35
30	40 (MED)

- Supply- and return-air grilles should not be blocked by items such as drapes, furniture, and toys. Restricted airflow reduces the efficiency of the humidifier, as well as that of the whole comfort system.
- The humidifier unit must be properly maintained on a regular basis.

STARTUP PROCEDURES

1. Open the saddle valve on the water supply line. (See Fig. 4.) Set humidistat to the desired relative humidity. (See Fig. 5 and Table 2.)
2. Turn the furnace on and adjust the thermostat to a high temperature setting. Be sure that the furnace blower is operating.
3. Check to see if water is flowing into the humidifier.

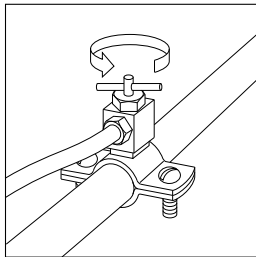

Fig. 4 — Saddle Valve

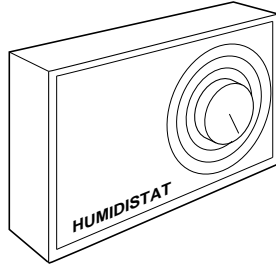

Fig. 5

- On a Model HUMCCLBP or Model HUMCCLFP humidifier, loosen the thumbscrew that holds the distributor cover to the top of the cabinet. Lift up the distributor cover slightly to make certain that water is flowing from the solenoid valve into the distributor pan. Do not lift the cover off the cabinet more than 1 in. when water is flowing. (See Fig. 6 or 7 according to the model you own.)

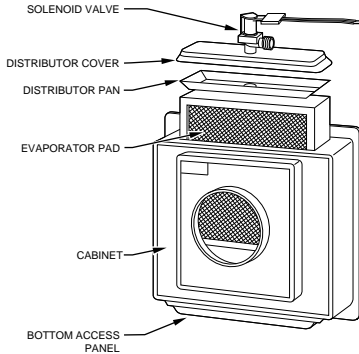

Fig. 6 — Model HUMCCLBP2018-A--

- On a Model HUMCCSBP humidifier, gently pull the latch that secures the access door. Remove the door. Check to see if water is flowing from the solenoid valve into the evaporator pad. (See Fig. 8.)
- On a Model HUMCCSFP humidifier, open the side door or the front cover. If the front cover is opened, hold the pad assembly in place. Check to see if water is flowing from the solenoid valve into the distributor pan. (See Fig. 9.)
- On a Model HUMCCWTR unit, look through the window on front of the unit to see that the evaporator pad is rotating and water is flowing. (See Fig. 10.)

The Model HUMCCWTR is controlled by a float valve. Turning off the furnace will not affect the water flow until float level is achieved. (See Fig. 11.)

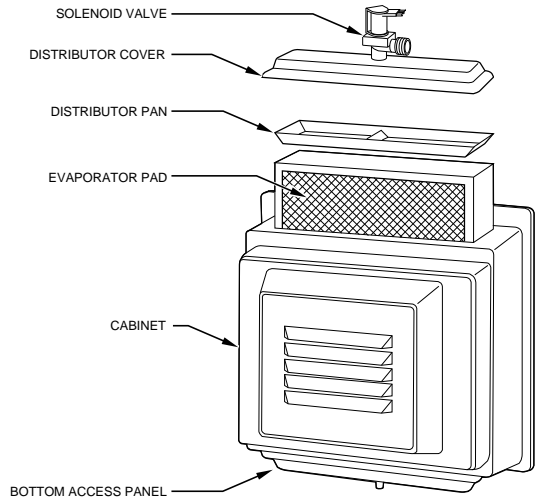

Fig. 7 — Model HUMCCLP1025-A--

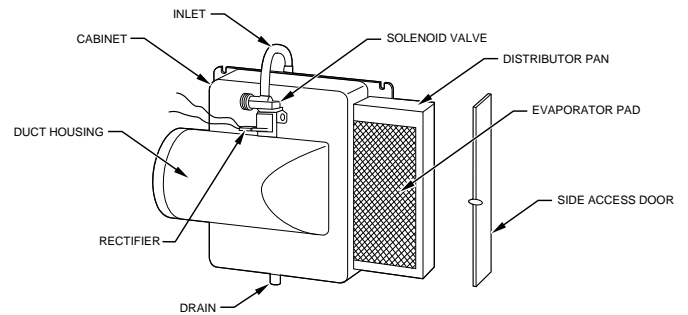

Fig. 8 — Model HUMCCSBP2017-A--

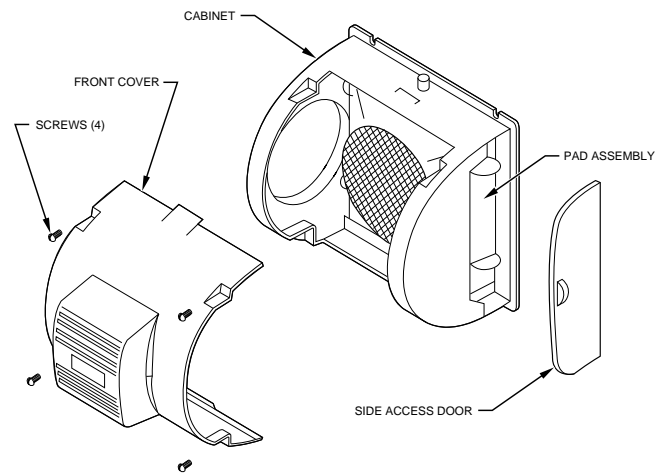

Fig. 9 — Model HUMCCSFP1016-A--

4. Turn off the furnace. When the blower stops, look into the humidifier to make sure the water is not flowing into the unit.
5. Replace the cover assembly and fasten securely.
6. Now, turn the furnace on and set the thermostat for desired room temperature.

SHUTDOWN PROCEDURES

To shut down your humidifier, close the saddle valve on the water line. Then turn off the humidistat. When set to the OFF position, the humidistat shuts off the electrical power to the solenoid valve on the humidifier.

NOTE: If your home comfort system includes cooling, be sure the water supply to your humidifier is **turned off** during the cooling season. Close the damper located in the bypass duct if one is installed. If your humidifier is a Model HUMCCWTR, drain and clean the water pan as described in cleaning procedures.

PERFORMING ROUTINE MAINTENANCE

With the proper maintenance and care, your humidifier will operate economically and dependably. Maintenance can be accomplished easily by referring to the following directions. However, before performing any maintenance, consider these important safety precautions:

- **DISCONNECT ALL ELECTRICAL POWER TO THE HUMIDIFIER AND FURNACE BEFORE PERFORMING ANY SERVICE OR MAINTENANCE TO AVOID PERSONAL INJURY.**

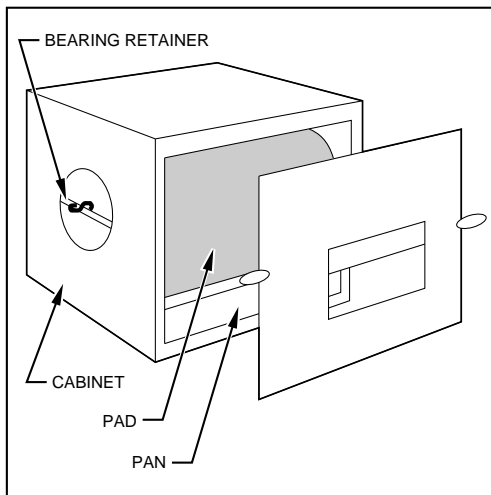

Fig. 10 — Model HUMCCWTR2019-A--

NOTE: THERE MAY BE MORE THAN 1 ELECTRICAL DISCONNECT SWITCH.

- ALTHOUGH SPECIAL CARE HAS BEEN TAKEN TO MINIMIZE SHARP EDGES IN THE CONSTRUCTION OF YOUR HUMIDIFIER, BE EXTREMELY CAREFUL WHEN HANDLING PARTS OR REACHING INTO THE UNIT TO AVOID PERSONAL INJURY.

Your humidifier has been designed for easy disassembly to simplify cleaning and servicing. Your unit must be kept clean to maintain its efficiency.

Regular inspection allows you to determine the cleaning schedule best suited to your humidifier's operating conditions. The frequency for required maintenance will depend most upon the available water supply. In areas where hard water and high mineral content are prevalent, more frequent cleaning and servicing may be required.

At minimum, the humidifier will need to be cleaned at the beginning of every heating season.

CLEANING PROCEDURES

Models HUMCCLBP, HUMCCSBP, HUMCCLFP, and HUMCCSFP

1. Turn off all electrical power to the humidifier and furnace or fan coil.
2. Turn off the humidifier's water supply. (See Fig. 4.)
3. Disassemble the humidifier.
 - To disassemble a Model HUMCCSBP humidifier, gently pull the latch that secures the access panel. Remove the door and slide the evaporator pad assembly out of the unit. (See Fig. 8.)
 - To disassemble either a Model HUMCCLBP or Model HUMCCLFP humidifier, first remove the water supply connection to the solenoid valve. Next, remove the screw that holds the distributor cover to the cabinet, and lift off the cover. Disconnect the drain line from the sump and loosen the thumbscrew(s) holding the sump to the cabinet. Remove the sump. Remove evaporator pad assembly. (See Fig. 6 or 7, according to the model you own.)
 - To disassemble a Model HUMCCSFP, the pad assembly can be removed from the side access door or the front cover. When removing the side door, lift the pad assembly up by holding the tabs and slide the assembly out. When removing the front cover on Model HUMCCSFP, disconnect the quick connects to the solenoid valve, unscrew the 4 screws to the front cover, snap loose the top and bottom catches, and lay the front cover aside. Once the front cover is off, lift the pad assembly up and twist it out. The pad assembly consists of 4 parts; the distributor pan, frame, sump, and the evaporator pad. Pull the distributor pan apart from the frame and the evaporator pad can be removed. Do not force the evaporator pad in or out without removing the distributor pan as this will distort the pad.
4. Clean the humidifier's external components.
 - If your humidifier is a Model HUMCCSBP humidifier, wash the access door and outlet drain portion of the cabinet. Make sure the drain is open.
 - If your humidifier is a Model HUMCCLBP or HUMCCLFP, wash the distributor cover, sump cover, and cabinet. Be sure the inlet ports are open and clean. Then, clean the sump with a solution of detergent and water.
5. Clean the internal components of your humidifier. Wash the distributor pan with a mild detergent and warm water. Be sure holes and slots in the pan are clean and unobstructed. Wash the evaporator pad assembly in a detergent solution. If there are scale deposits on the pad, soak it in ordinary household vinegar. If the pad is covered by a heavy deposit of scale, or if the local water supply has high sulfate or calcium content, replace the pad with a new one. Contact your dealer for replacement part.
6. Reassemble your humidifier.
7. Turn on the electrical power and water supplies. Refer to the startup procedures.

Model HUMCCWTR

1. Turn off all electrical power to the humidifier and furnace or fan coil.
2. Turn off the humidifier's water supply. (See Fig. 4.)
3. Drain water from the unit. Place a pail underneath the drain plug located on the bottom of the humidifier cabinet. Lift the tab on the drain plug and remove the plug. Allow all water to drain from the unit. (See Fig. 12.)

4. Remove the front door from the humidifier. Rotate the latches one-half turn, then pull the door forward.
5. Remove and inspect the evaporator pad assembly. Lift the bearing from its retainer. (See Fig. 10.) Pull the assembly away from the motor to disengage the assembly shaft from the motor coupling. Remove assembly through the access opening.

Inspect the evaporator pad. If the pad is heavily loaded with scale, or if the local water has a high sulfate content, replace the pad. Contact your dealer for replacement part.

NOTE: For best performance, the evaporator pad should be replaced before each heating season.

6. Inspect the float assembly. Remove the float arm from the valve body by sliding out the pin and lifting off the float arm. (See Fig. 11.) Inspect the rubber valve seat located inside the float arm. If the seat appears to be nicked or worn, invert the seat or replace it with the spare valve seat located on the float arm. Inspect the water opening in the valve body. If the opening is clogged, use a pin to remove the obstruction. Remove any accumulated deposits from the valve body and float arm.
7. Clean the water pan and unit cabinet. Tilt the water pan and lift it from the unit. Wash the pan with warm, soapy water. Flex the pan to loosen accumulated scale. Wash the unit interior, removing any accumulated deposits. Inspect the drain line to insure that no blockage has occurred. Clean as required. (See Fig. 12.)
8. Reassemble your Model HUMCCWTR humidifier. Reinsert the water pan and drain plug. Ensure that the overflow tube is inserted into the hole at the bottom of the cabinet. Attach the float arm to the valve body by aligning the holes on both parts and reinserting the pin. *Do not force or bend the pin.* The float arm should have free up-and-down movement. Install the evaporator pad assembly. Ensure that the square shaft engages the motor coupling and that the bearing washer is located inside the bearing retainer. Turn the water on. Adjust float by rotating until water covers inside of foam drum. Attach the access door and turn the latches.

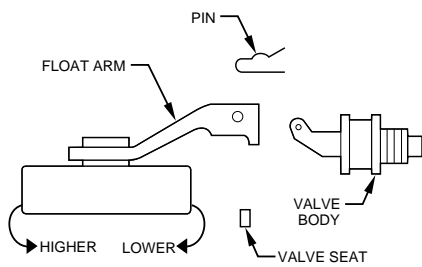

Fig. 11 — Float Arm Removal

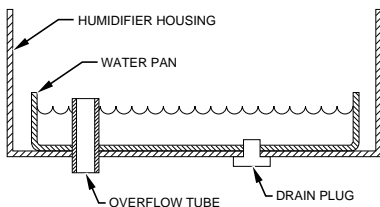

Fig. 12 — Cleaning Water Pan and Unit Cabinet

9. Turn on electrical power supplies. Refer to startup procedures listed on page 3.

BEFORE YOU REQUEST A “SERVICE CALL”

BEFORE YOU CALL FOR SERVICE, CHECK FOR THESE EASILY SOLVED PROBLEMS:

- Check the main power disconnect switch. Verify that the circuit breakers are on and that fuses have not blown. If you must reset breakers or replace fuses, do so only once. Contact your servicing dealer for assistance if the breakers trip or the fuses blow a second time.

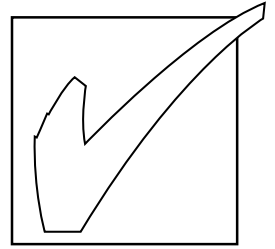

- If the humidity level is too low, check the humidistat setting. Confirm that the saddle valve is turned on. Check the evaporator pad, and clean or replace the pad as necessary. Check water level in Model HUMCCWTR.
- Check for sufficient airflow. Check the furnace filter or electronic air cleaner for excessive accumulations of dirt. Check for blocked return- or supply-air grilles. Be sure grilles are open and unobstructed.
- If water drips from the humidifier, check the drain hose for kinks or obstructions. If your unit is a Model HUMCCWTR, dripping may indicate that the float valve requires adjustment.

If your comfort system still fails to operate properly, contact your servicing dealer for troubleshooting and repairs. Specify your apparent problem, and state the model and serial numbers of your equipment. (You should have them recorded where noted in this booklet.) With this information, your dealer may be able to offer helpful suggestions over the phone, or save valuable time through knowledgeable preparation for the service call.

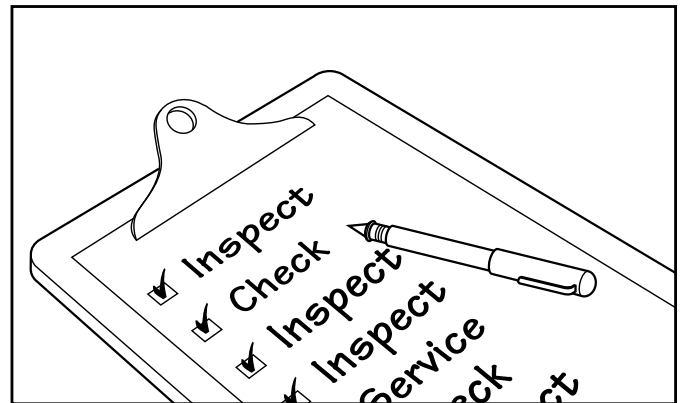

REGULAR DEALER MAINTENANCE

In addition to the routine maintenance that you perform, your humidifier should be inspected regularly by a properly trained service technician. The inspection (preferably each year, but at least every other year) should include the following:

- Routine inspection of the humidifier. Cleaning, if necessary. Cleaning or replacement of the evaporator pad as required.
- A check of all electrical wiring and connections.
- A check of water connections to the unit.
- Operational check of the complete comfort system to determine actual working condition. Necessary repair and/or adjustment should be performed at this time.

Your servicing dealer may offer an economical service contract that covers seasonal inspections. Ask for further details.

Record the model and serial numbers of your new humidifier in the following spaces. This information, along with the other ready-reference facts requested below, may be required if you should ever need information or service.

Model No. _____

Serial No. _____

Date Installed _____

Dealer Name _____

Address _____

City _____

State _____ Zip _____

Telephone _____



Carrier

A United Technologies Company

TO OBTAIN INFORMATION ON PARTS: Consult your installing dealer or the classified section of your local telephone directory under the "Heating Equipment" or "Air Conditioning Contractors & Systems" heading for dealer listing by brand name. Have available the Model No., Series Letter, & Serial No. of your equipment to ensure correct replacement part

Carrier Corporation • Indianapolis, IN 46231

Manufacturer reserves the right to discontinue, or change at any time, specifications or designs without notice and without incurring obligations.