



ROOM AIR CONDITIONER **OWNER'S MANUAL**

Please read the operating instructions and safety precautions carefully and thoroughly before installing and operating your room air conditioner.

MANUEL D'UTILISATION **CLIMATISEUR DE FENÊTRE**

Veuillez lire attentivement et en entier ce guide d'utilisation et les mesures de sécurité ci-incluses avant de procéder à l'installation et au fonctionnement de votre climatiseur.

AIRE ACONDICIONADOR **MANUAL DEL PROPIETARIO**

Por favor lea las instrucciones de operación y las precauciones de seguridad cuidadosa y totalmente antes de instalar y operar su acondicionador de aire de ventana.

MODELS, MODÉLES, MODELOS: HBLG5000

Manufactured by LG Electronics

Safety Precautions

Safety Precautions3

About the Controls on the Air Conditioner

Controls5
 Air Direction6
 Care and Maintenance6

Features and Installation

Features7
 Window Requirements8
 Electrical Data10

Before You Call For Service...

Normal Operating11
 Abnormal Operation11



FOR YOUR RECORDS

Write down the model and serial numbers here:

Model # _____

Serial # _____

You can find them on a label on the side of each unit.

Dealer's Name _____

Date Purchased _____

Staple your receipt here for proof of purchase.

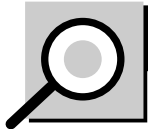

READ THIS MANUAL

Inside you will find many helpful hints on how to use and maintain your air conditioner properly. Just a little preventive care on your part can save you a great deal of time and money over the life of your air conditioner.

You'll find many answers to common problems in the chart of troubleshooting tips. If you review our chart of **Troubleshooting Tips** first, you may not need to call for service at all.



CAUTION

- Contact an Authorized Service Center for repair or maintenance of this unit. Call 1-800-243-0000 to locate the nearest ASC.
- The air conditioner is not intended for use by young children or invalids without supervision.
- Young children should be supervised to ensure that they do not play with the air conditioner.



Safety Precautions

To prevent injury to the user or other people and property damage, the following these instructions.

- Incorrect operation due to ignoring instructions will cause harm or damage. The seriousness is classified by the following indications.
- Because of the weight of the product, it is recommended that you have a helper to assist in the installation.
- **Use Caution! Sharp Edges! See Warning, page 4.**



WARNING

This symbol indicates the possibility of death or serious injury.



CAUTION

This symbol indicates the possibility of injury or damage to properties only.

- Meanings of symbols used in this manual are as shown below.



Be sure not to do this.



Be sure to follow the instructions.



WARNING

Plug in the power plug properly.

- Otherwise, it will cause electric shock or fire due to heat generation.

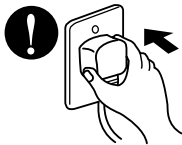

Do not operate or stop the unit by inserting or pulling out the power plug.

- It will cause electric shock or fire due to heat generation.

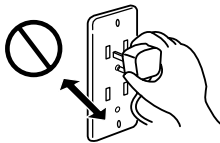

Do not damage or use an unspecified power cord.

- It will cause electric shock or fire.
- If the power cord is damaged, it must be replaced by the manufacturer or its service agent or a similarly qualified person in order to avoid a hazard.



Do not modify power cord length or share the outlet with other appliances.

- It will cause electric shock or fire due to heat generation.

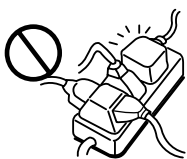

Do not operate with wet hands or in damp environment.

- It will cause electric shock.



Do not direct air flow at room occupants only.

- This could lead to health problems.

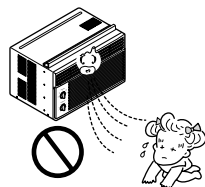



CAUTION

When the air filter is to be removed, do not touch the metal parts of the unit.

- They are sharp and may cause an injury.

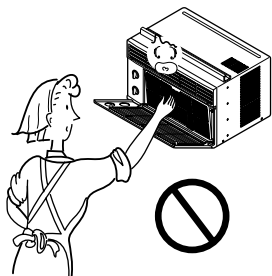

Do not clean the air conditioner with water.

- Water may enter the unit and degrade the insulation. It may cause an electric shock.

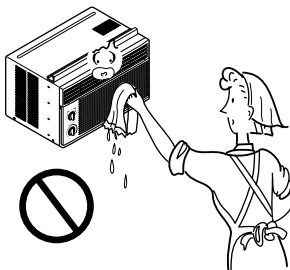

When the unit is to be cleaned, switch the unit off, and unplug it.

- Since the fan rotates at high speed during operation, it may cause an injury.

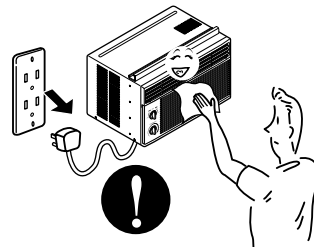

Do not operate the unit without the air filter or when the front intake grille has been removed.

- It could cause dust to accumulate on the heat exchanger.

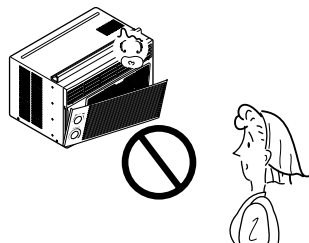

Do not put a pet or house plant where it will be exposed to direct air flow.

- This could injure the pets or plants.

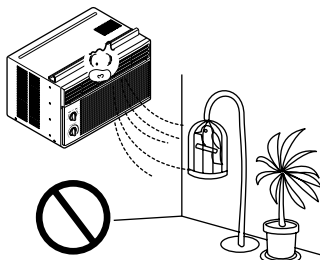

Do not use for special purposes.

- Do not use this air conditioner to preserve precision devices, food, pets, plants, and art objects. It may cause deterioration of quality, etc.

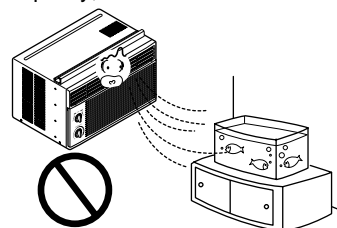

Do not operate switches with wet hands.

- It may cause an electric shock.

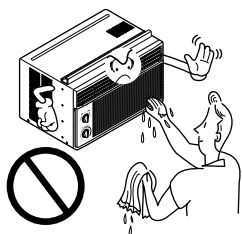

Do not apply an insecticide or flammable spray.

- It may cause a fire or deformation of the cabinet.

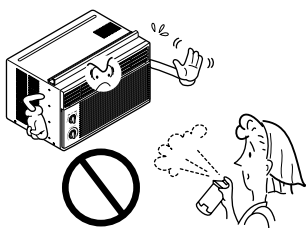

SHARP EDGES!
The edges of the case can be SHARP!

- Use caution when handling the case. Grip it firmly and do not allow it to slip while holding it.
- Use heavy gloves to handle the case if necessary.
- DO NOT allow the case to slide against your skin!

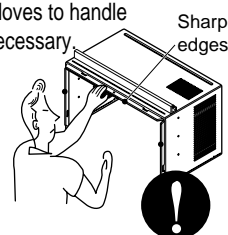

About the Controls on the air conditioner

The controls will look like one of the following.

Controls

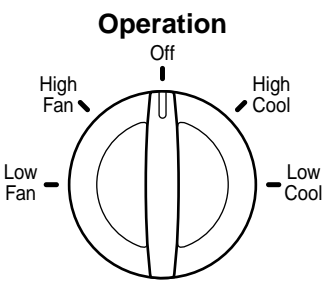
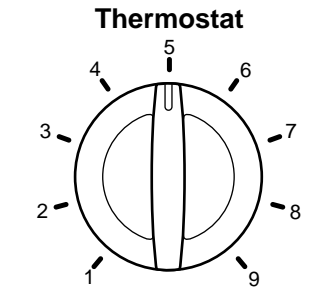
<p>Operation</p> 	<p>Off - Turns air conditioner off.</p> <p>High Fan - High speed fan operation without cooling.</p> <p>Low Fan - Low speed fan operation without cooling.</p> <p>High Cool - Cooling with high speed fan operation.</p> <p>Low Cool - Cooling with low speed fan operation.</p>
<p>Thermostat</p> 	<p>This automatically controls the temperature of the indoor air.</p> <p>Turn the knob so that arrow points to the larger marks for greater cooling.</p> <p>Point the arrow to the smaller marks for more moderate cooling.</p> <p>(i.e. the higher number, the greater cooling)</p>

• FOR NORMAL COOLING

1. Turn the operation switch to the **High Cool** or the **Low Cool** setting.
2. Set the thermostat control to the desired temperature mark 5 (the mid-point is a good starting position). If the room temperature is not satisfactory after a reasonable time, adjust the control to a cooler or warmer setting, as appropriate.

• FOR MAXIMUM COOLING

1. Turn the operation switch to the **High Cool** setting.
2. Set the thermostat control to the largest 9 temperature mark.

• FOR QUIETER OPERATION

1. Turn the operation switch to the **Low Cool** setting.
2. Set the thermostat control as needed.

• CAUTION

When the air conditioner has been performed its cooling operation and is turned off or set to the fan position, wait at least 3 minutes before resetting to the cooling operation again.

Additional controls and important information.

Air Direction

• **ADJUSTING THE AIR DIRECTION USING THE HORIZONTAL AIR-DEFLECTOR CONTROL**

Using the control tabs, the air flow can be directed to the left, right, straight ahead, or any combination of these directions.

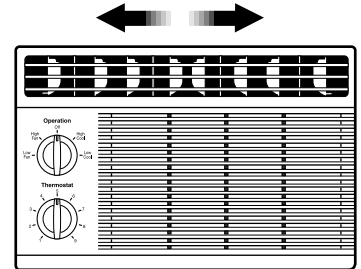

Care and Maintenance

TURN THE AIR CONDITIONER OFF AND REMOVE THE PLUG FROM THE POWER OUTLET.

• **TO CLEAN FILTER**

The air filter will become dirty as it removes dust from the inside air. It should be washed at least every 2 weeks. If the air filter remains full of dust, the air flow will decrease and the cooling capacity will be reduced, possibly damaging the unit.

1. Pull the inlet grille forward and pull out the air filter. (Fig. 1)
2. Wash the air filter in warm 104°F (40°C) water. Be sure to shake off all the water before replacing the filter.

Do not force open or open to far.

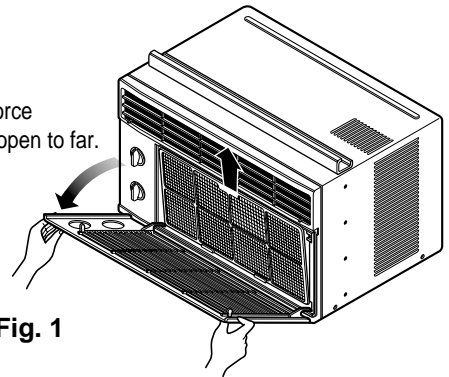
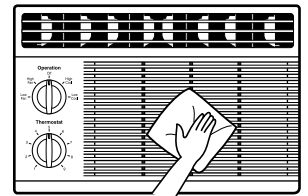

Fig. 1

• **CLEANING THE AIR CONDITIONER**

The front grille and Inlet grille may be wiped with a cloth dampened in a mild detergent solution. (Fig. 2) The cabinet may be washed with mild soap or detergent and lukewarm water, then polished with Liquid Wax for Appliances.

Fig. 2



To ensure continued peak efficiency, the condenser coils (outside of unit) should be checked periodically and cleaned if clogged with soot or dirt from the atmosphere.

• **HOW TO REMOVE THE FRONT GRILLE**

1. Remove the thermostat knob and the operation knob by pulling.
2. Remove the screw securing the Front Grille. (Fig. 3)
3. Push the grille up from the bottom and pull the top of the grille away from the case as the top tabs lift out of their slots. (Fig. 4)

Fig. 3

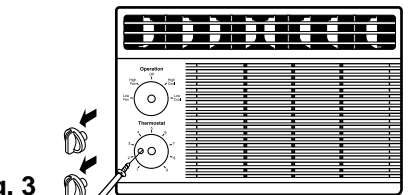
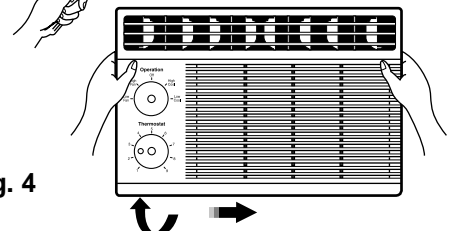

Fig. 4



Features and Installation

Learning parts name prior to installation will help you understand the installation procedure.

Features

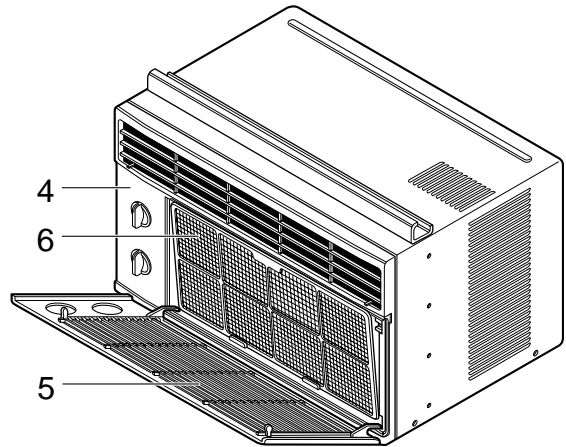
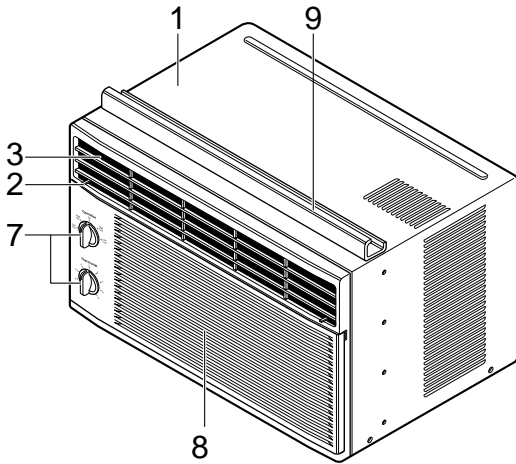

- 1. CABINET
- 2. HORIZONTAL AIR DEFLECTOR
- 3. COOL AIR DISCHARGE
- 4. FRONT GRILLE
- 5. INLET GRILLE

- 6. AIR FILTER
- 7. KNOBS
- 8. AIR INTAKE
- 9. UPPER GUIDE

Window Requirements

NOTE: All supporting parts should be secured to firm wood, masonry, or metal.

1. This unit is designed for installation in standard double hung windows with actual opening widths of 22" to 36". The upper and lower sash must open sufficiently to allow a clear vertical opening of 13" from the bottom of the sash to the window stool.
2. If storm window presents interference, fasten a 2" wide wood strip to the inner window sill across the full width of the sill. The wood strip should be thick enough to raise the height of the window sill so that the unit can be installed without interference by the storm window frame. See Fig. 5-2. The top of the wood strip should be approximately $\frac{3}{4}$ " higher than the storm window frame (STORM WINDOW FRAME) or wood strip (OUTDOORS) to help condensation to drain properly to the outside.
3. Install a second wood strip (approximately 6" long by $1\frac{1}{2}$ " wide and same thickness as first strip) in the center of the outer sill flush against the back off the inner sill. This will raise the L bracket as shown Fig. 5-2.
4. If the distance between STORM WINDOW FRAME and WOOD STRIP MOUNTED ON TOP OF INNER SILL is more than 1", two of wood strips are not necessary.

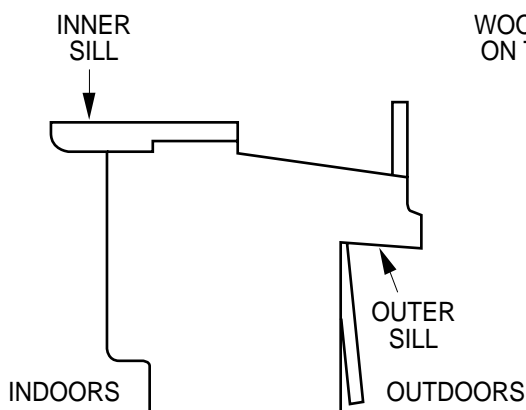

Fig. 5-1

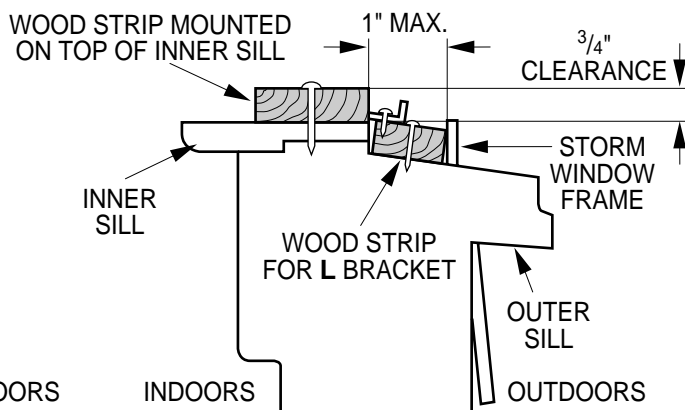
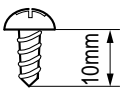
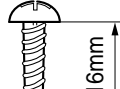
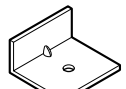
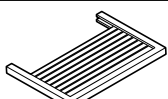



Fig. 5-2

Installation

HARDWARE			
TYPE A: 11EA (SHORT SCREW)	TYPE B: 5EA (WOOD SCREW)	TYPE C: 3EA (L BRACKET)	
			
TYPE D: 1EA (SEAL STRIP)	TYPE E: 1EA (SASH SEAL)	TYPE F: 2EA (GUIDE PANEL)	TYPE G: 1EA (SUPPORT BRACKET)
(Adhesive backed)	(Not adhesive backed)		

A. BEFORE INSTALLATION

1. Insert the guide panels into the guides of the air conditioner. Fasten the curtains to the unit with screws (TYPE A), as shown Fig. 6.
2. Cut the adhesive-backed seal strip (TYPE D) to the window width.
Remove the backing from the seal strip and attach the seal strip to the underside of the bottom window. (Fig. 7)

B. NOW START INSTALLATION

1. LOCATING UNIT IN WINDOW

Open the window and mark center line on the center of the inner sill, as shown in Fig. 8.

2. ATTACH L BRACKET

- a. Install the L brackets behind the inner window sill, with short side of bracket as shown. Use the 2 screws (TYPE A) provided.
- b. The bracket helps to hold unit securely in place.
Be sure to place bracket edge flush against back of inner sill. See Fig. 9.

CAUTION

During the following step, hold unit firmly until window sash is lowered to top channel behind side panel frames. Personal injury or property damage may result if unit falls from window.

3. INSTALL THE AIR CONDITIONER IN THE WINDOW

- a. Carefully lift the air conditioner and slide it into the open window. Make sure the bottom guide of the air conditioner drops into the notches of the L bracket. See Fig. 9.

IMPORTANT :

When the air conditioner drops into the L bracket, the air conditioner will be centered in window opening as shown in Fig. 10.

- b. While steadying the air conditioner, carefully bring the window sash down behind the upper guide of the air conditioner, as shown in Fig. 11.

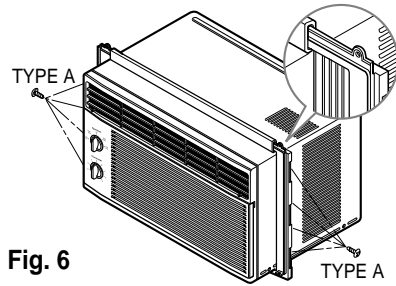

Fig. 6

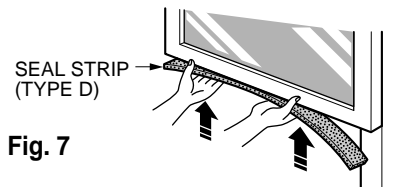

Fig. 7

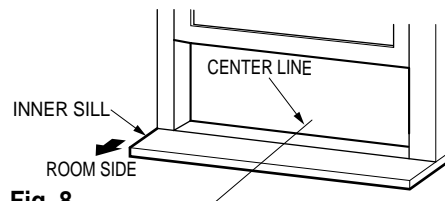

Fig. 8

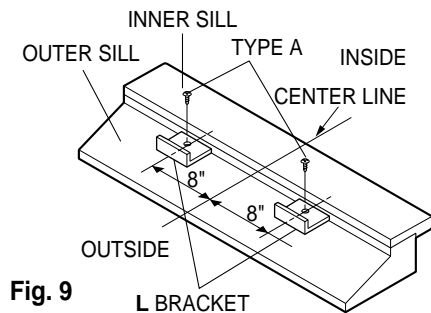

Fig. 9

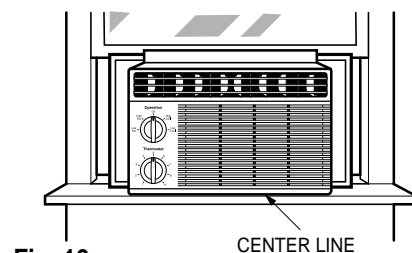

Fig. 10

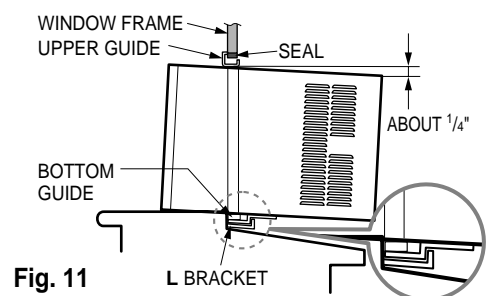

Fig. 11

4. SECURE THE GUIDE PANELS

Extend the guide panels (TYPE F) to fill the window opening using 4 screws (TYPE B) to secure them, as shown in Fig. 12.

5. INSTALL THE SASH SEAL AND SASH LOCK

- a. Cut the sash seal (TYPE E) to the window width. Stuff the sash seal between the glass and the window to prevent air and insects from getting into the room, as shown in Fig. 12.
- b. Fasten the L bracket using a screw (TYPE A), as shown in Fig. 12.

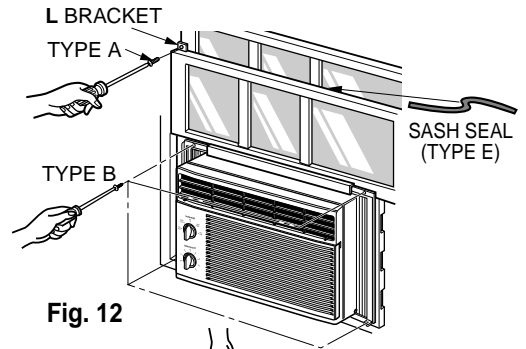

Fig. 12

6. a. Remove the screws that secure the cabinet and base pan in the right side.
- b. Fasten the support bracket (TYPE G) using a removed screw. Attach the support bracket (TYPE G) in the inner window sill with a screw (TYPE B), as shown in Fig. 13.

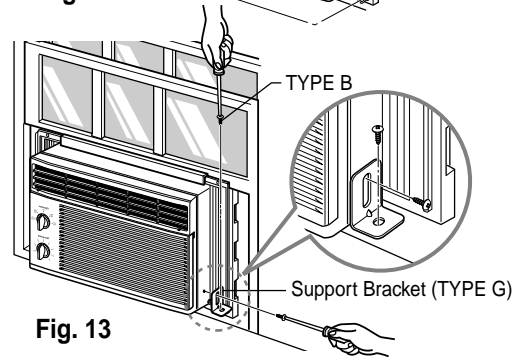

Fig. 13

7. Window installation of room air conditioner is now completed. See ELECTRICAL DATA for attaching power cord to electrical outlet.

C. HOW TO SECURE THE DRAIN PIPE

In humid weather, excess water may cause the BASE PAN to overflow. To drain the water, remove the DRAIN CAP and secure the DRAIN PIPE to the rear hole of the BASE PAN. (Fig. 14) Press the drain pipe into the hole by pushing down and away from the fins to avoid injury.

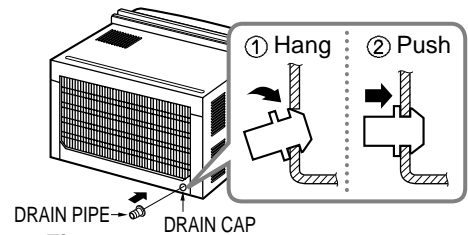
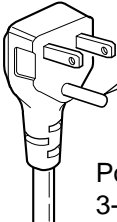
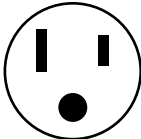

Fig. 14

REMOVAL FROM WINDOW

Turn the air conditioner off, disconnect the power cord, remove the L bracket, the screws and Support Bracket installed through the top and bottom of the guide panels, and save for reinstallation later. Close the guide panels. Keeping a firm grip on the air conditioner, raise the sash, and carefully tilt the air conditioner backward, draining any condensate. Lift the air conditioner from the window and remove the sash seal from between the windows.

Electrical Data

Line Cord Plug	Use Wall Receptacle	Power Supply
 <p>Do not under any circumstances cut or remove the grounding prong from the plug.</p> <p>Power supply cord with 3-prong grounding plug</p>	 <p>Standard 125V, 3-wire grounding receptacle rated 15A, 125V AC</p>	<p>Use 15 AMP, time delay fuse or circuit breaker.</p>

USE OF EXTENSION CORDS

Because of potential safety hazards, we strongly discourage the use of an extension cord. However, if you wish to use an extension cord, use a CSA certified/UL-listed 3-wire (grounding) extension cord, rated 15A, 125V.

Before you call for service...

Troubleshooting Tips save time and money!
Review the chart below first and you may not need to call for service.

Normal Operating

- You may hear a pinging noise caused by water being picked up and thrown against the condenser on rainy days or when the humidity is high. This design feature helps remove moisture and improve efficiency.
- You may hear the thermostat click when the compressor cycles on and off.
- Water will collect in the base pan during high humidity or on rainy days. The water may overflow and drip from the outdoor side of the unit.
- The fan may run even when the compressor does not.

Abnormal Operation

Problem	Possible Causes	What To Do
Air conditioner does not start	■ <i>The air conditioner is unplugged.</i>	• Make sure the air conditioner plug is pushed completely into the outlet.
	■ <i>The fuse is blown/circuit breaker is tripped.</i>	• Check the house fuse/circuit breaker box and replace the fuse or reset the breaker.
	■ <i>Power failure.</i>	• If power failure occurs, turn the mode control to Off . When power is restored, wait 3 minutes to restart the air conditioner to prevent tripping of the compressor overload.
Air conditioner does not cool as it should	■ <i>Airflow is restricted.</i>	• Make sure there are no curtains, blinds, or furniture blocking the front of the air conditioner.
	■ <i>The THERMOSTAT may not be set high enough.</i>	• Turn the knob to a higher number. The highest setting provides maximum cooling.
	■ <i>The air filter is dirty.</i>	• Clean the filter at least every 2 weeks. See the care and Maintenance section.
	■ <i>The room may have been hot.</i>	• When the air conditioner is first turned on, you need to allow time for the room to cool down.
	■ <i>Cold air is escaping.</i>	• Check for open furnace floor registers and cold air returns.
Air conditioner freezing up	■ <i>Cooling coils have iced up.</i>	• See Air Conditioner Freezing Up below.
	■ <i>Ice blocks the air flow and stops the air conditioner from cooling the room.</i>	• Set the mode control at High Fan or High Cool with thermostat at 1 or 2.