

Operation Details

The function of main control

1. Time delay Safety Control

- 3min... The compressor is ceased for 3minutes to balance the pressure in the refrigeration cycle. (Protection of compressor)
- 5sec... Vertical air flow direction control louvers open in 5 seconds to prevent noise between louvers and wind.
- 30sec... The 4-way valve is ceased for 30sec. to prevent the refrigerant-gas abnormal noise when the Heating operation is OFF or switched to the other operation mode while compress is off. While compressor is running, it takes 3~5 seconds to switch.

2. Airflow Direction Control

- This function is to swing the louver up and down automatically and to set it at the desired position.
- The procedure is as the following.
 - 1st ; Press the ON/OFF Button to operate the product.
 - 2nd ; Press the Airflow Direction Control Button to swing the louver up and down automatically.
 - 3rd ; Reprress the Airflow Direction Control Button to set the louver as the desired position.

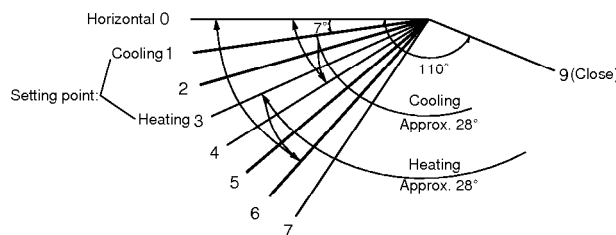

3. Cooling Mode Operation

- When selecting the Cooling(*) Mode Operation, the unit will operate according to the setting by the remote controller and the operation diagram is as following.

INTAKE AIR TEMP.					
SETTING TEMP. +0.5°C (COMPRESSOR ON)					
SETTING TEMP. -0.5°C (COMPRESSOR OFF)					
INDOOR FAN SPEED	Selecting fan speed	Low	Selecting fan speed	Low	Selecting fan speed
COMPRESSOR	ON	OFF	ON	OFF	ON

4. Cooling or Heating Mode with Sleep Mode Auto Operation

- When selecting the Cooling(*) or the Heating(✱) combined with the Sleep Mode Auto Operation(☆), the operation diagram is as following.

■ **Cooling Mode with the Sleep Mode**

- The setting temperature will be raised by 1°C 30minutes later and by 2°C 1 hour later.
- The operation will be stopped after 1, 2, 3, 4, 5, 6, 7 hours.

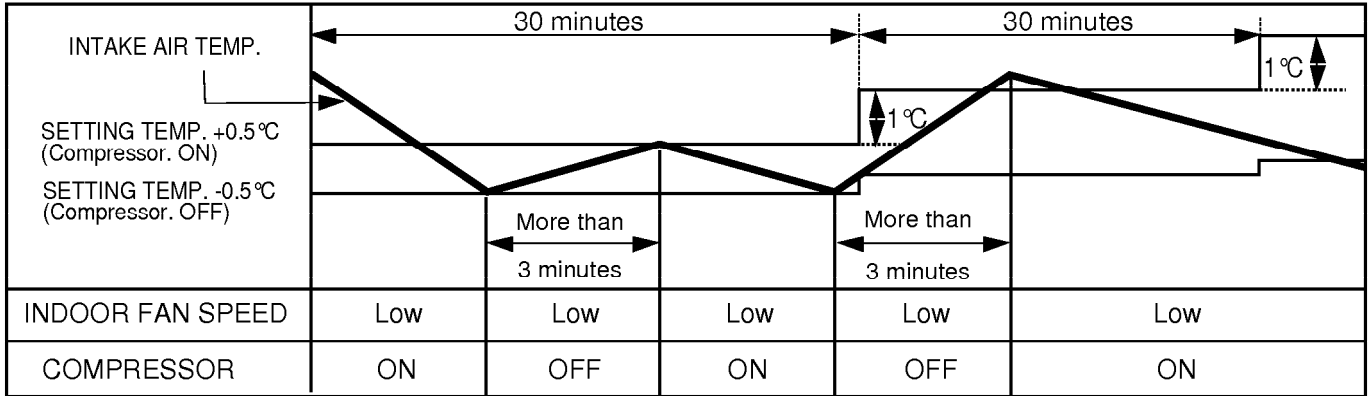

■ **Heating Mode with the Sleep Mode**

- The operation will be stopped after 1, 2, 3, 4, 5, 6, 7 hours.

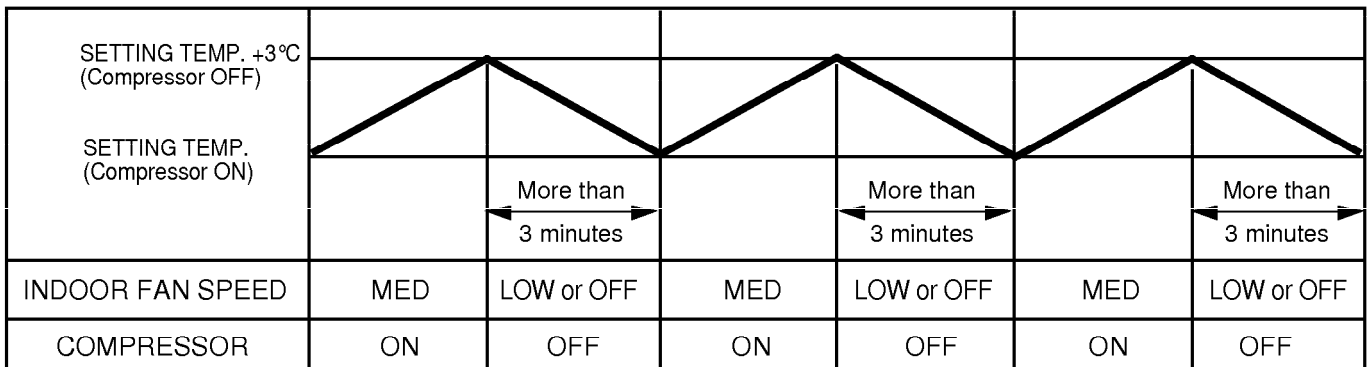

5. Auto Operation (Fuzzy Operation)

- The operation procedure is as following. (Cooling & Heating Model)

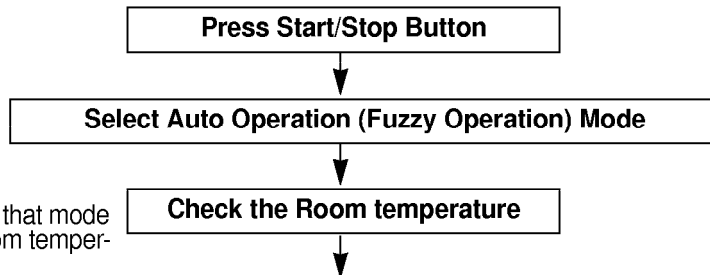

* If initial mode is decided, that mode is continued without the room temperature changing.

Operation mode Indoor fan speed Setting temperature	are automatically decided by Fuzzy rule.		
Intake-air temperature	below 21 °C	Over 21 °C ~ below 24 °C	Over 24 °C
Operation Mode	Heating	Soft Dry	Cooling

* For cooling operation mode over 24 °C setting temperature and fan speed are same as cooling only model.

■ Auto Operation(Fuzzy Operation) for Cooling (Cooling only Model)

Operation Condition	Intake-air Temperature	Setting Temperature	Fan Speed	Air DirectionControl
When Auto Operation initial start	Over 26 °C	25 °C	Controlled by Fuzzy logic	In this mode, when pressing the vertical air direction control button, louvers moves to 1/f rhythm (refer to page 17)
	Over 24 °C~below 26 °C	Intake air -1 °C		
	Over 22 °C~below 24 °C	Intake air -0.5 °C		
	Over 20 °C~below 22 °C	Intake air temperature		
	below 20 °C	20 °C		
When pressing room temperature setting button during Auto Operation	Over 20 °C~below 30 °C	Fuzzy control		
	below 20 °C	20 °C		
	over 30 °C	30 °C		

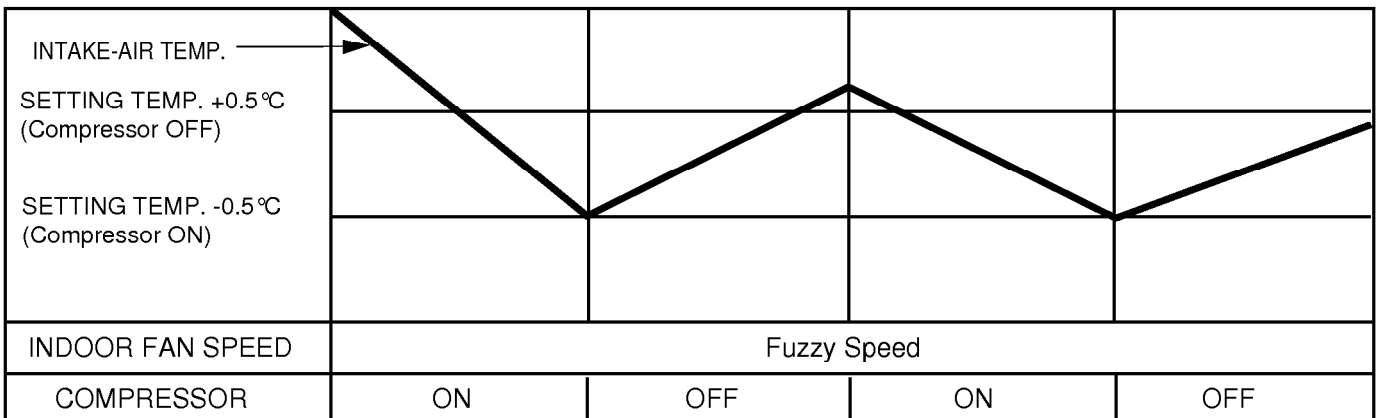

■ Auto Operation (Fuzzy Operation) for Soft Dry

- The Setting temperature will be same that of the auto operation for cooling.
 - Compressor ON temperature; Setting temperature +1 °C
 - Compressor OFF temperature; Setting temperature -0.5 °C

■ Auto Operation (Fuzzy Operation) for Heating

Intake Air temp.	Below 20°C	Over 20°C~below 21°C	Over 30°C
Setting temp.	20°C	Intake air temperature +0.5°C	30°C

- Compressor ON temperature; Setting temperature
- Compressor OFF temperature; Setting temperature +3°C

- 1/f rhythm louver operation : In Auto operation mode, when pressing the vertical air direction control button, louver moves as following cycle.

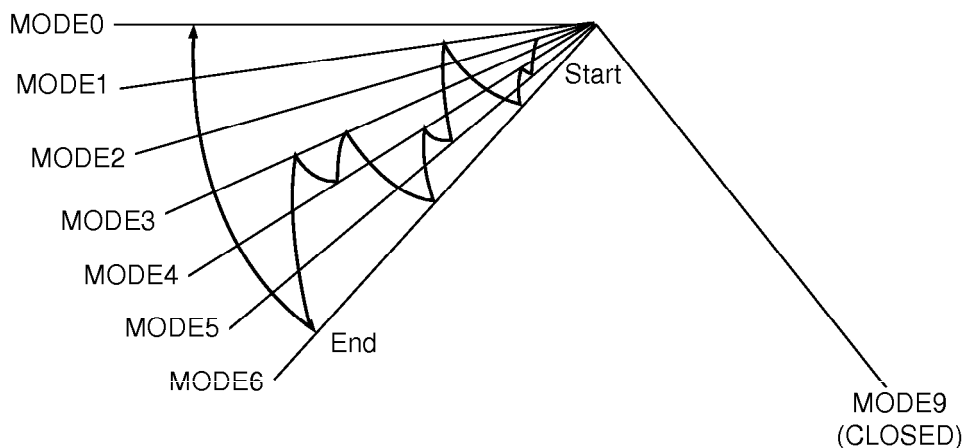

6.Natural Wind by CHAOS logic

There are common rules in the irregular changes amid the breeze of highlands and valleys, the sound of streams, the songs of birds in the forest and brain waves of relaxation.

Mmm.... the breath-taking and touchy feeling of wind from the deep mountains and dark valleys.

Through analysis in its chaos simulator, Goldstar had successfully created such a feeling of freshness and serenity by analyzing the frequency of natural wind.

Generally natural wind has the following character (frequency-Magnitude), for example dark valley, sea, mountain wind.

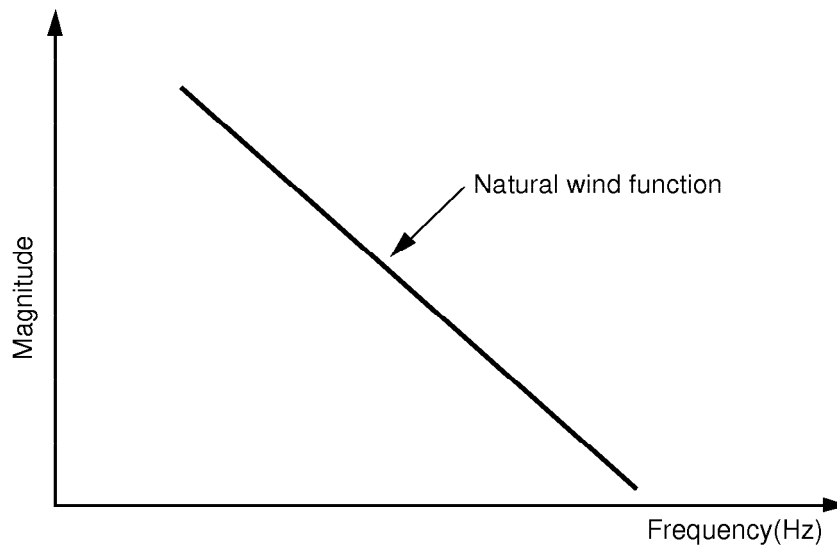

So as to make a similar Natural wind function, Indoor fan speed is shifted to high from low or reversely according to the CHAOS logic.

7. Heating Mode Operation

The unit will operate according to the setting by the remote controller and the operation diagram is shown as following.

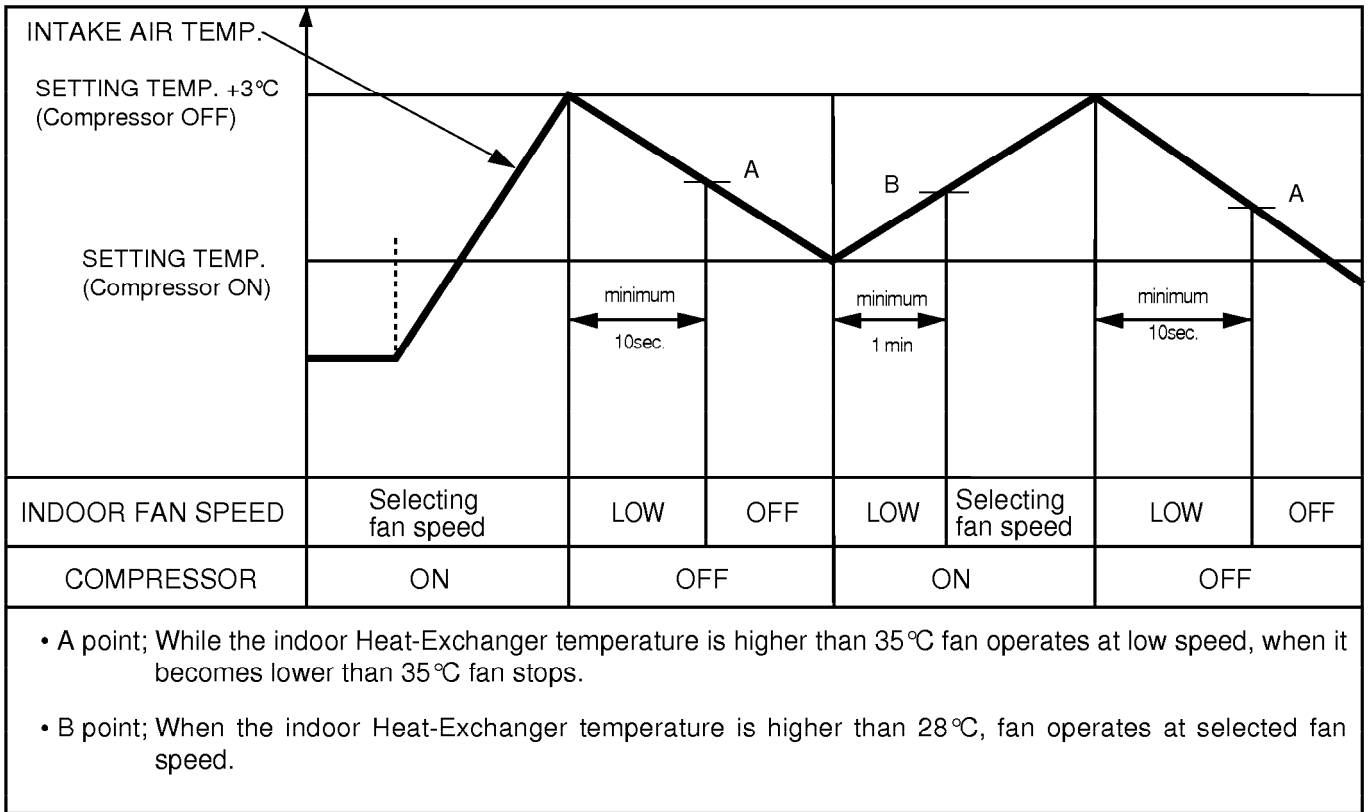

8.Hot-Start Control

- The indoor fan stops until the evaporator piping temperature will be reached to 28°C.
- During heating operation, if piping temperatures falls below 26°C fan stops.
- The operation diagram is as following.

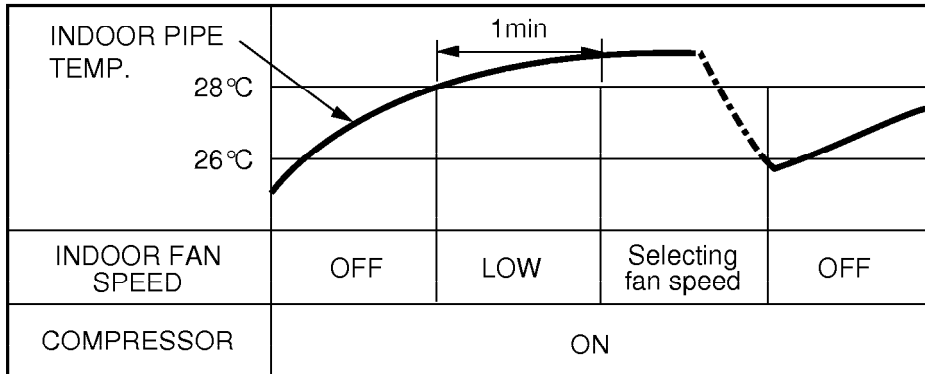

9.Defrost Control

- Defrost operation is controlled by timer and sensing temperature of outdoor pipe.
- The first defrost starts only when the outdoor pipe temperature falls below -6°C after 60 minutes passed from starting of heating operation and more than 10 minutes operation of compressor.
- Defrost ends after 12 minutes passed from starting of defrost operation or when the outdoor pipe temperature rises over 12°C even if before 12 minutes.
- The second defrost starts only when the outdoor pipe temperature falls below -6°C after 60 minutes passed from ending of the first defrost and more than 10 minutes operation of compressor.

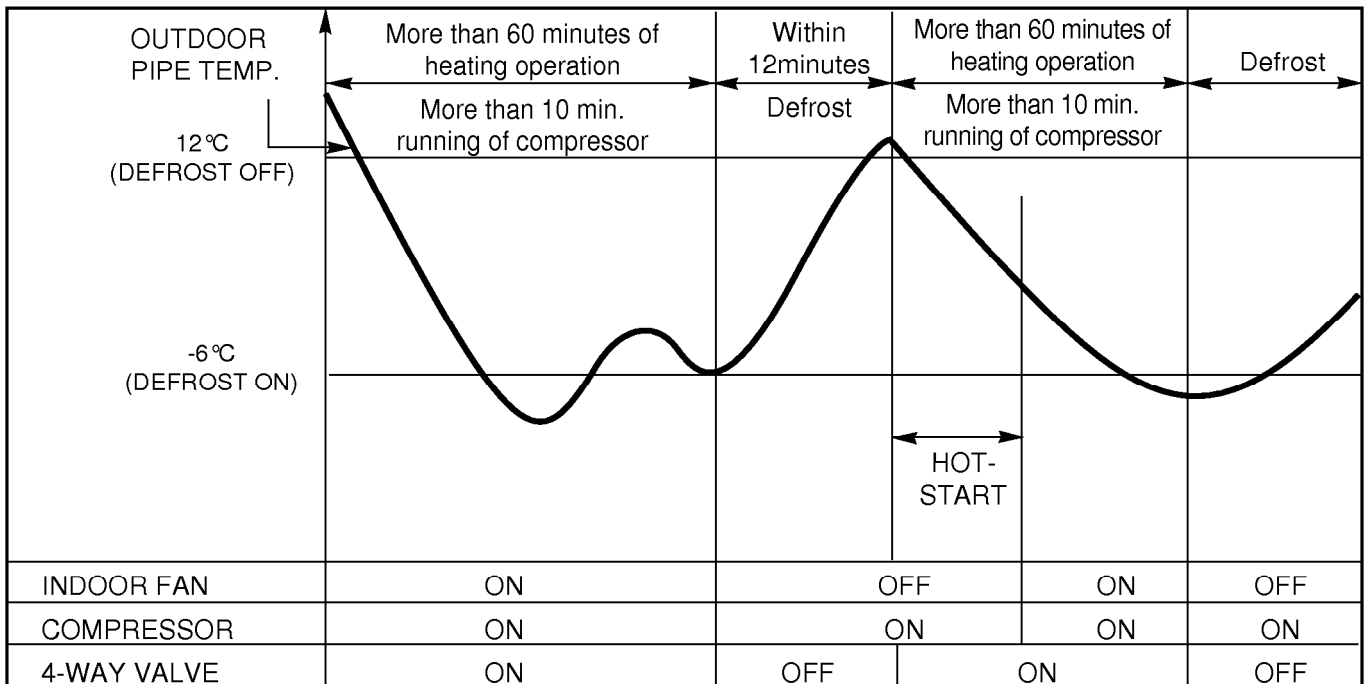

10. Soft Dry Operation Mode

- During Soft Dry Operation, the compressor ON temperature is the setting temperature plus 1 °C, the compressor OFF temperature is the setting temperature minus 0.5 °C.
- When the room temperature rises over the compressor ON temperature, the operation mode is switched to the Cooling mode.
- When the room temperature falls between the compressor ON temperature and OFF temperature, the operation mode is switched to the Soft Dry Operation.
- The operation diagram is shown below.

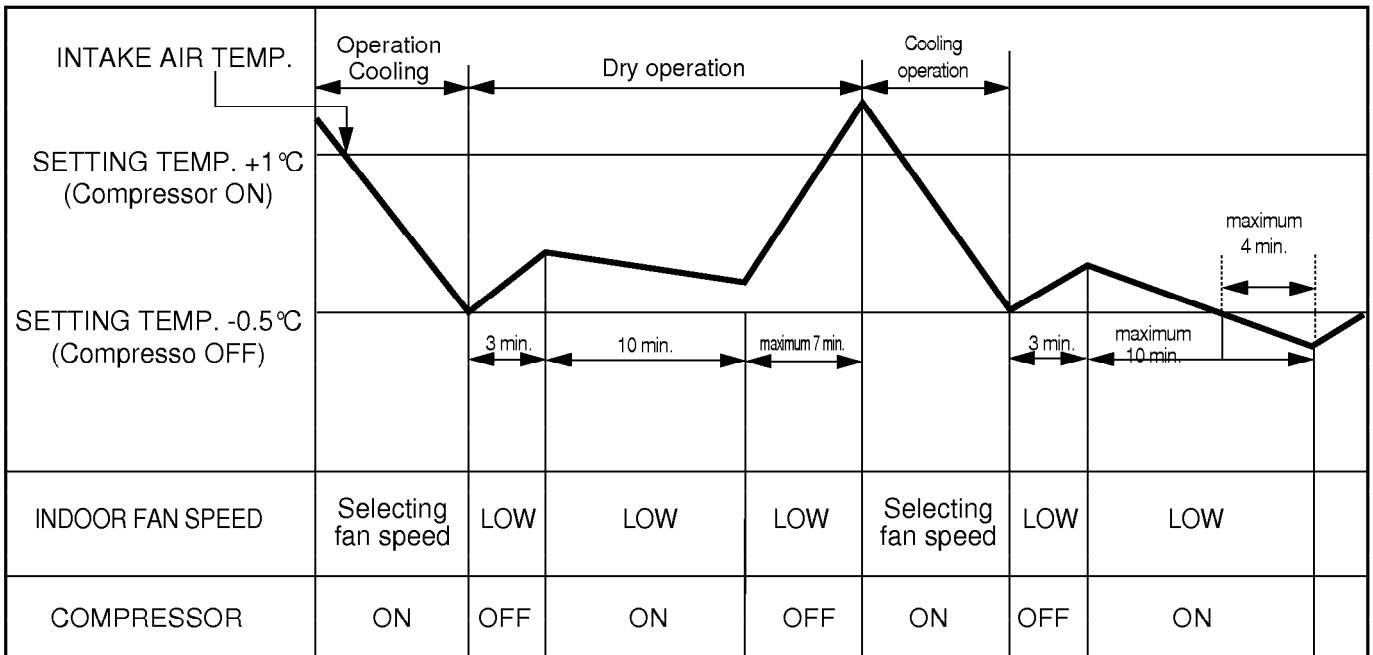

11. Protection of the evaporator pipe from frosting

§ 24K, 26K, 28K MODELS

- Outdoor fan motor stops when indoor pipe temperature is below 3 °C and restarts at the pipe temperature above 6 °C or after 90 seconds, if the pipe temperature does not rise to 6 °C, outdoor fan motor runs continuously at even below 3 °C.

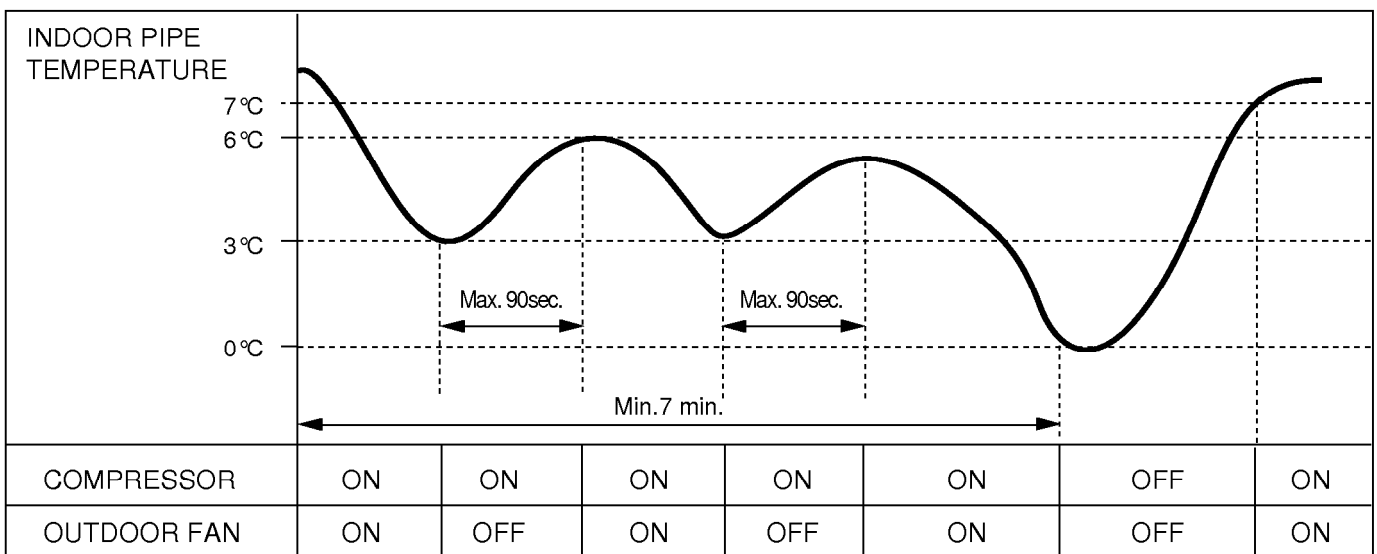

§ 18K MODELS

- Compressor and outdoor fan stop when indoor pipe temperature is below 0 °C and restart at the pipe temperature is above 7 °C.

12. Forced Operation

- If you lose wireless remote controller, you can operate the unit with forced operation switch.
- The standard conditions are as following.

	Cooling Model	Heat pump Model		
		Room Temp. $\geq 24^{\circ}\text{C}$	$21^{\circ}\text{C} \leq \text{Room Temp.} < 24^{\circ}\text{C}$	Room Temp. $< 21^{\circ}\text{C}$
Operation Mode	Cooling	Cooling	Soft Dry	Heating
FAN Speed	High	High	Soft Dry Rule	High
Setting Temp.	22°C	22°C	23°C	24°C

- Unit operation in low fan mode for first 15 seconds, then switched to proper operation mode according to intake Air temperature.

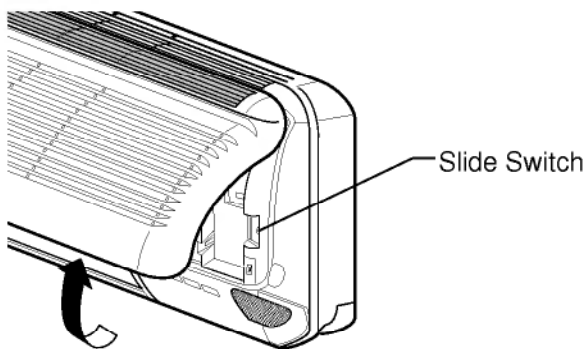

Open the front panel upward

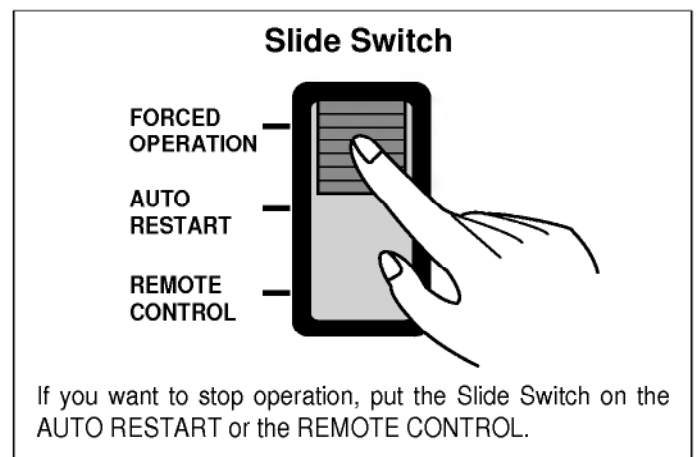

13. Auto Restarting Operation

- In case the power comes again after the power failure, Auto Restarting Operations the function to operate procedures automatically to the previous operating conditions.
- If you want to use this operation, open the front panel upward and put the Slide Switch on the AUTO RESTART.
- If you do not want to use this operation, put the Slide Switch on the REMOTE CONTROL.

