

This Owner's Manual is provided and hosted by [Appliance Factory Parts](#).

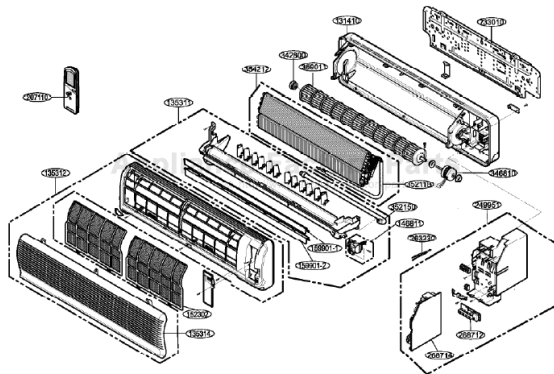

LG HMC021M2E9 Owner's Manual

[Shop genuine replacement parts for LG HMC021M2E9](#)



[Find Your LG Air Conditioner Parts - Select From 2328 Models](#)

----- Manual continues below -----

Operation Details

1. Time Delay Safety Control

- 3min... The compressor is ceased for 3 minutes to balance the pressure in the refrigeration cycle. (Protection of compressor)
- 5sec... The indoor fan is delayed for 5 seconds, when operating initially, to prevent noises occurred by the vertical louver and wind.
- 30sec... The 4-way valve is ceased for 30 sec. to prevent the refrigerant-gas abnormal noise when the Heating operation is OFF or switched to the other operation mode.

2. Airflow Direction Control

- This function is to swing the louver up and down automatically and to set it at the desired position.
- The procedure is as the following.
 - 1st ; Press the ON/OFF Button to operate the product.
 - 2nd ; Press the Airflow Direction Control Button to swing the louver up and down automatically.
 - 3rd ; Re-press the Airflow Direction Control Button to set the louver as the desired position.

Operating Mode		Louver Position
Cooling	Start	2
	Auto. Swing	1~4
Heating	Start	5
	Auto. Swing	3~6

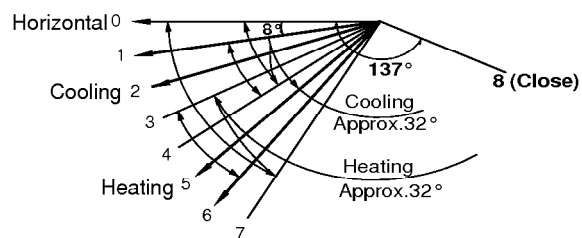

3. Cooling Mode Operation

- When selecting the Cooling(✳) Mode Operation, the unit will operate according to the setting by the remote controller and the operation diagram is as following.

Intake Air temp.					
COMP. ON (SET TEMP. +0.5°C)					
COMP. OFF (SET TEMP. -0.5°C)	More than 3 minutes		More than 3 minutes		
INDOOR FAN	Selecting fan speed	Low	Selecting fan speed	Low	Selecting fan speed
COMPRESSOR	ON	OFF	ON	OFF	ON

4. Cooling or Heating Mode with Sleep Mode Auto Operation

- When selecting the Cooling(✳) or the Heating(☼) combined with the Sleep Mode Auto Operation(☆), the operation diagram is as following.

■ **Cooling Mode with the Sleep Mode.**

- The setting temperature will be raised by 1°C 30 minutes later and by 2°C 1 hour later.
- The operation will be stopped after 1, 2, 3, 4, 5, 6, 7 hours.

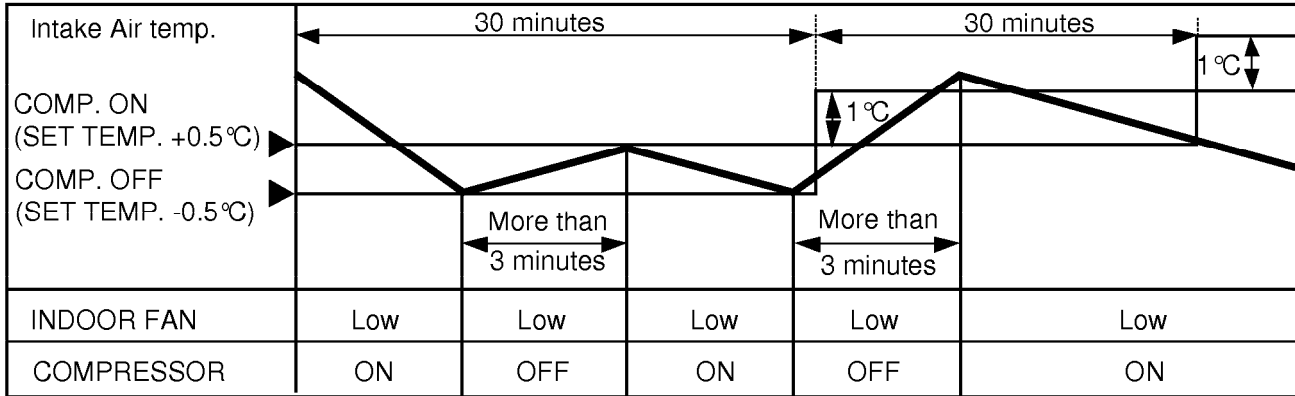

■ **Heating Mode with the Sleep Mode.**

- The operation will be stopped after 1, 2, 3, 4, 5, 6, 7 hours.

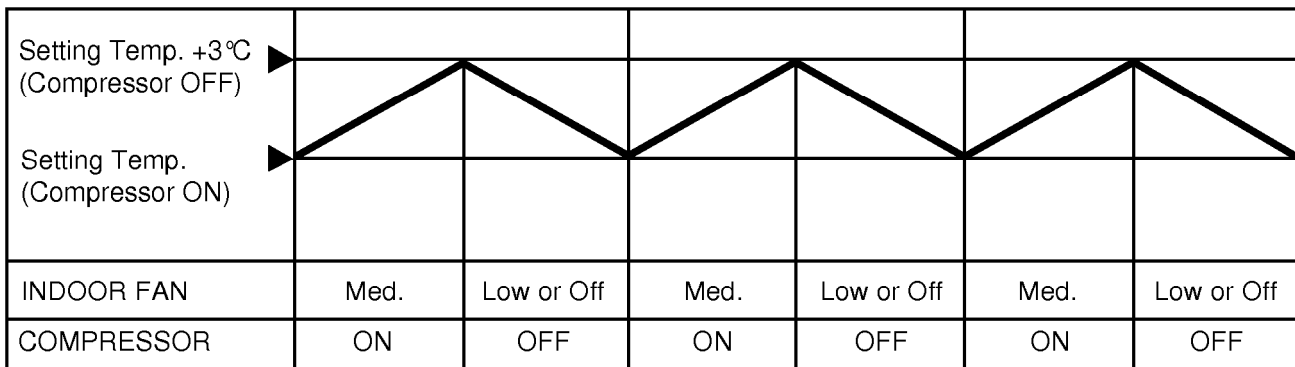

5. Auto Operation

•The operation procedure is as following.

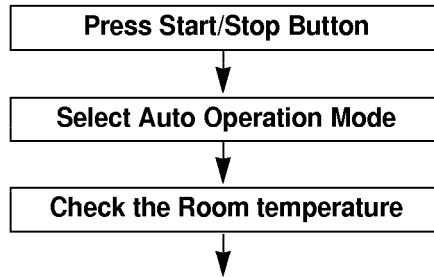

Operation mode Indoor fan speed Setting temperature				are automatically decided by Fuzzy rule.
Intake-air temperature	below 21 °C	Over 21 °C ~ below 24 °C	Over 24 °C	
Operation Mode	Heating	Soft Dry	Cooling	

* If initial mode is decided, that mode is continued despite of the room temperature changing.

■ Auto Operation for Cooling

Operation condition	Intake-air Temperature	Setting Temperature	Fan speed	Air DirectionControl
When Auto Operation initial start	Over 26 °C	25 °C	Controlled by Fuzzy logic	1/f rhythm
	Over 24 °C~below 26 °C	Intake air -1 °C		
	Over 22 °C~below 24 °C	Intake air -0.5°C		
	Over 20 °C~below 22 °C	Intake air temperature		
	below 20 °C	20 °C		
When Switch to Auto Operation	Over 20 °C~below 30 °C	Fuzzy control		
	below 20 °C	20 °C		-
	over 30 °C	30 °C		-

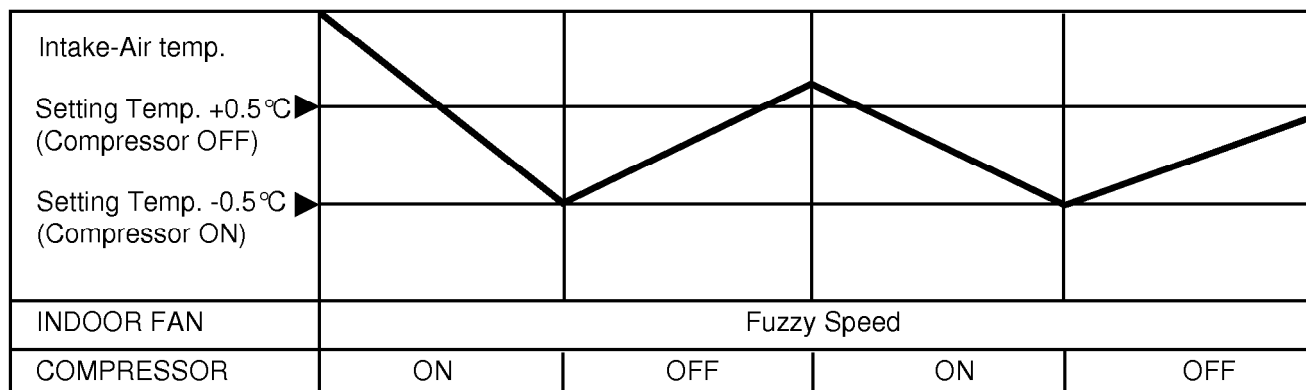

■ **Auto Operation for Soft Dry**

- The Setting temperature will be set to the same that of the current intake-air temperature.
 - Compressor ON temperature; Setting temperature +1 °C
 - Compressor OFF temperature; Setting temperature -0.5 °C

■ **Auto Operation for Heating**

Intake Air temp.	Below 20 °C	Over 20 °C~below 21 °C
Setting temp.	20 °C	Intake air temperature +0.5 °C

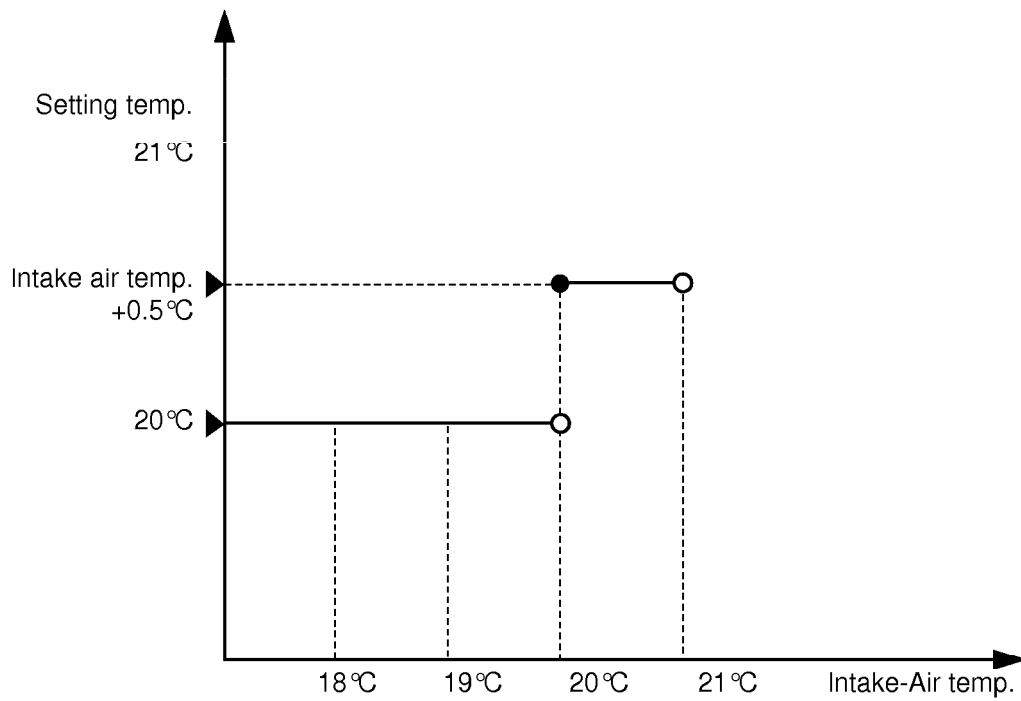

6. Natural Wind by CHAOS logic

There are common rules in the irregular changes amid the breeze of highlands and valleys, the sound of streams, the songs of birds in the forest and brain waves of relaxation.

Mmm... the breath-taking and touchy feeling of wind from the deep mountains and dark valleys.

Through analysis in its chaos simulator, LG has successfully created such a feeling of freshness and serenity by analyzing the frequency of natural wind.

Generally natural wind has the following character (Frequency-Magnitude), for example dark valley, sea, mountain wind.

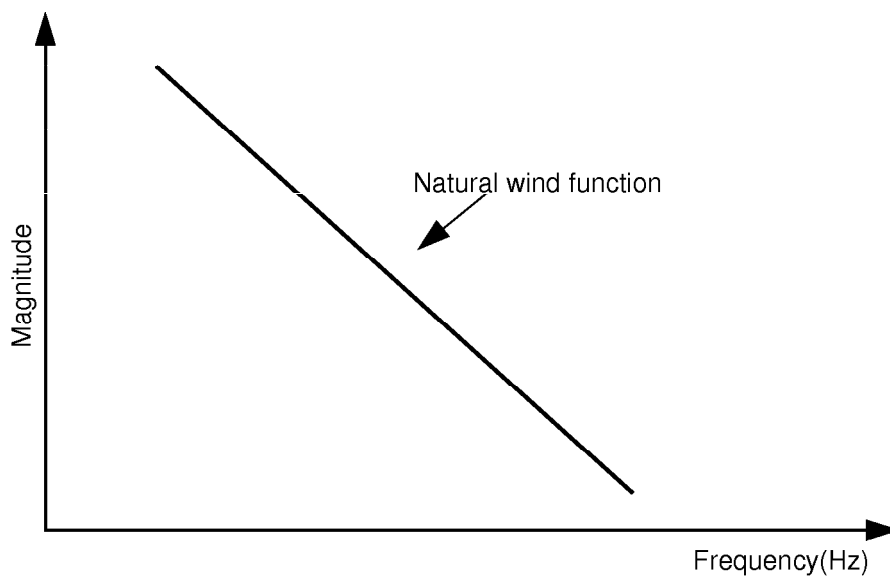

So as to make a similar Natural wind function, Indoor fan speed is shifted to high from low or reversely in according to the CHAOS logic.

7. Heating Mode Operation(Heating Model)

The unit will operate according to the setting by the remote controller and the operation diagram is shown as following.

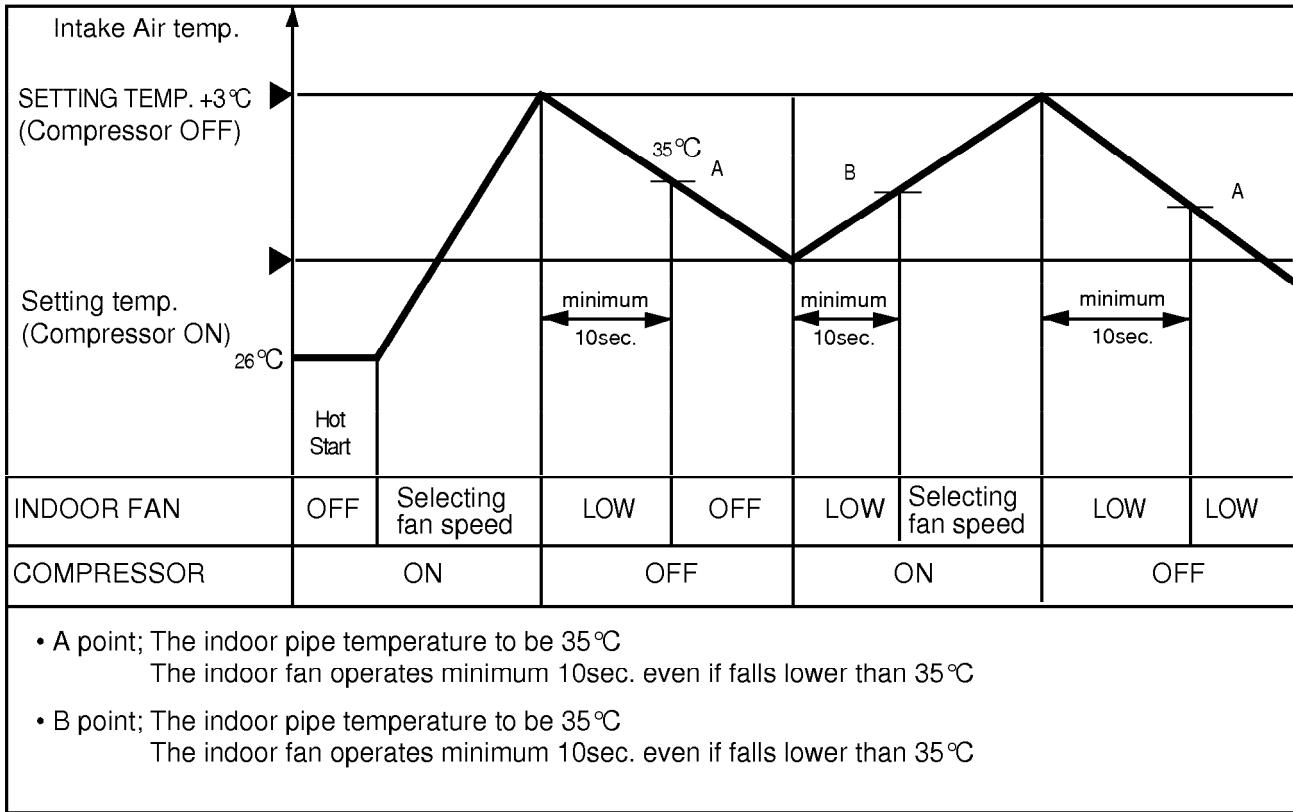

8. Hot- Start Control(Heating Model)

- The indoor fan stops until the evaporator piping temperature will be reached at 28°C.(BY TEMPERATURE)
- The operation diagram is as following.

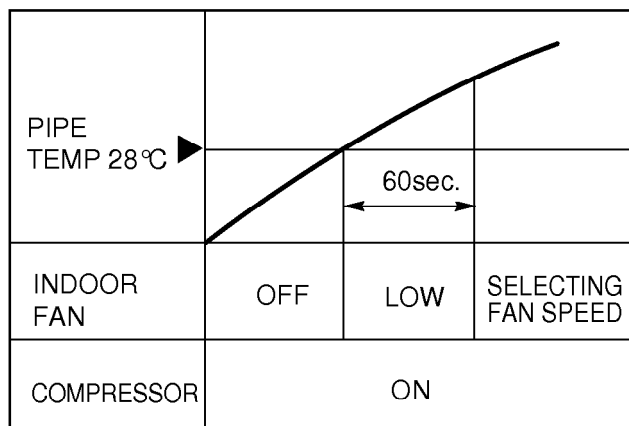

(HOT-START BY TEMPERATURE)

9. Defrost Control(Heating Model)

- Defrost operation is controlled by timer and sensing temperature of outdoor pipe.
- The first defrost starts only when the outdoor pipe temperature falls below -6°C after 60 minutes passed from starting of heating operation and more than 10 minutes operation of compressor.
- Defrost ends after 12 minutes passed from starting of defrost operation or after the outdoor fan operates within max. 2 minutes 30 seconds when the outdoor pipe temperature rises over 12°C even if before 12 minutes.
- The second defrost starts only when the outdoor pipe temperature falls below -6°C after 60 minutes passed from ending of the first defrost and more than 10 minutes operation of compressor.

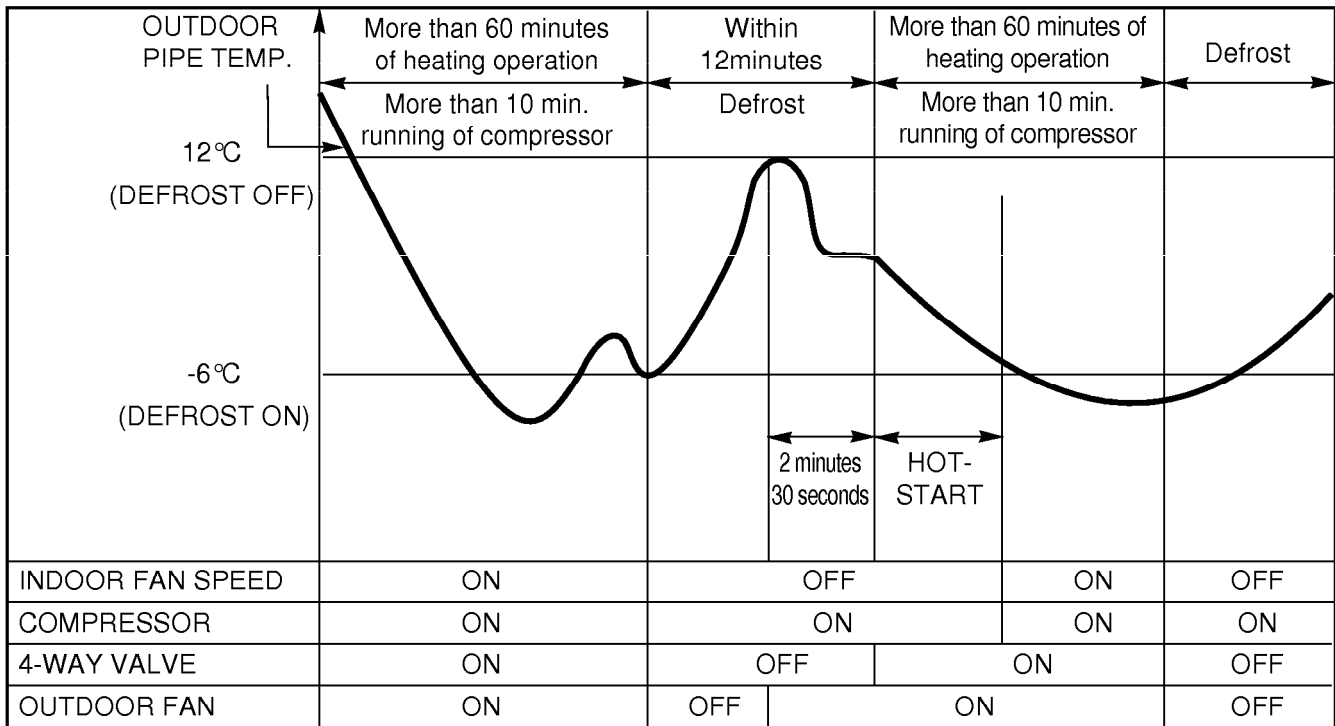

10. Soft Dry Operation Mode

- During Soft Dry Operation, the compressor ON temperature is the setting temperature plus 1 °C, the compressor OFF temperature is the setting temperature minus 0.5 °C.
- When the room temperature rises over the compressor ON temperature, the operation mode is switched to the Cooling operation.
- When the room temperature falls between the compressor ON temperature and OFF temperature, the operation mode is switched to the Soft Dry operation.
- The operation diagram is shown below.

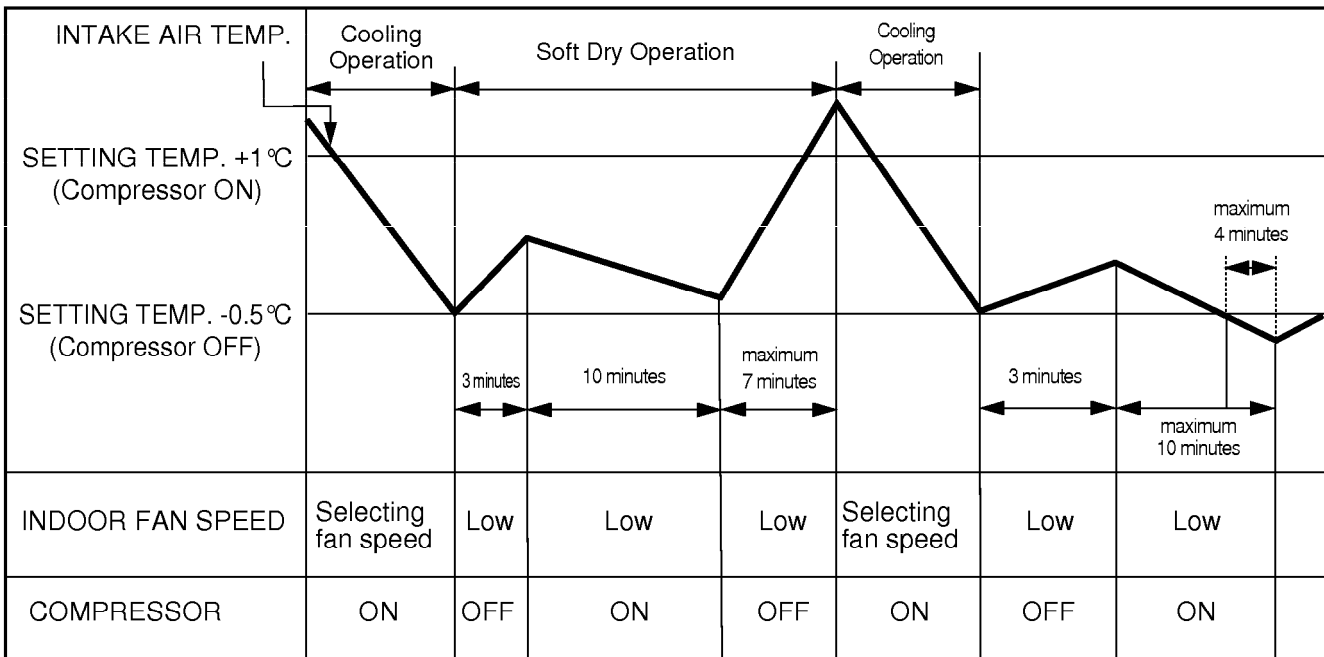

11. Cooling overload(Heating Model)

- Control indoor fan by sensing outdoor pipe temperature.
- One step down from setting fan speed if pipe temperature is over 50 °C and if below 45 °C, operate on setting temperature.

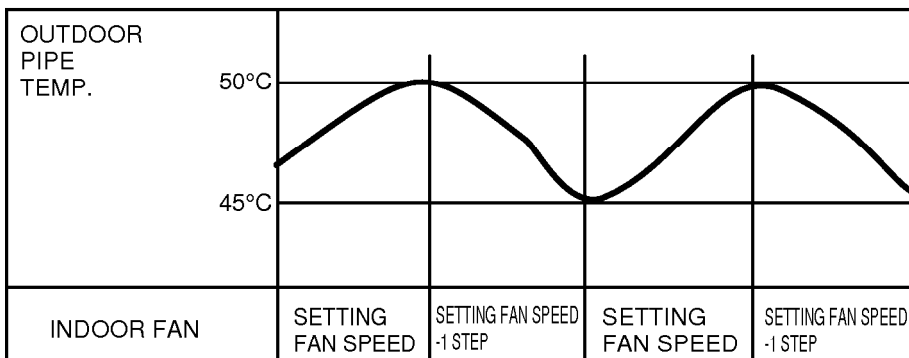

12. Heating overload(Heating Model)

- Outdoor fan ON/OFF by sensing outdoor pipe temperature.
- Outdoor fan is OFF if pipe temperature is over 6.5°C and outdoor fan is ON if pipe temperature is below 0°C.
- Outdoor fan is off if any one part is heating overload condition.

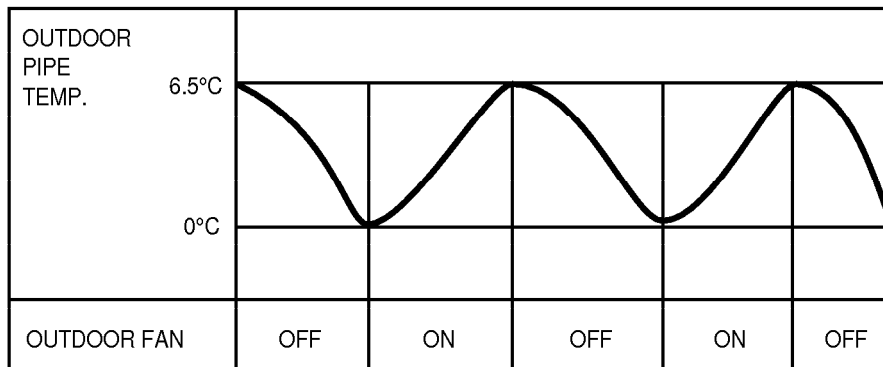

13. Heating low temperature compensation function(Heating Model)

- In heating mode, indoor fan speed is one step lower if outdoor pipe temperature is below 34°C, operate as setting temperature if above 38°C.

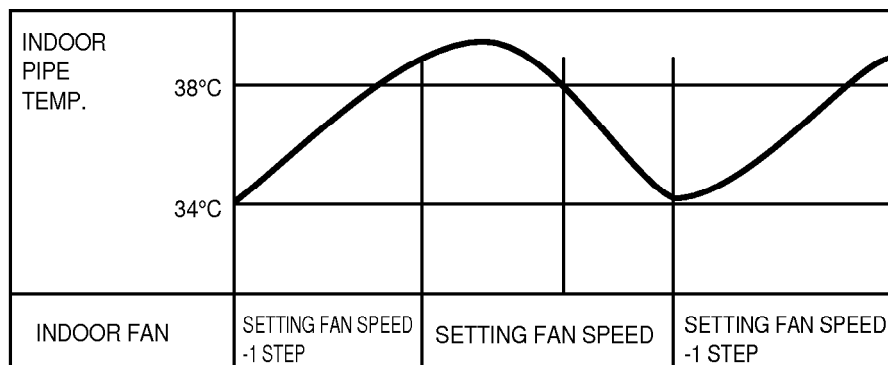

14. Buzzer ring function(Heating Model)

- Buzzer frequency ring changeable according to operation condition.
 - When initial power supply is reset, buzzer frequency is increasing with sound "di, ri, ri, ring" and then buzzer rings.
 - When operation is on, buzzer frequency is increasing with sound of "di, ri, ring" and then buzzer rings.
 - When operation is off, buzzer frequency is decreasing with sound of "di, ri, ring" and then buzzer rings.
 - When input remote key except operation/stop key, "ding" is ringing.
- At the time of performance/stop reservation, there is no buzzer.

15. Forced Operation

- If you lose wireless remote controller, you can operate the unit with forced operation switch.
- The standard conditions are as following.

	Cooling Model	Heat pump Model		
		Room Temp $\geq 24^{\circ}\text{C}$	$21^{\circ}\text{C} \leq \text{Room Temp} < 24^{\circ}\text{C}$	Room Temp $< 21^{\circ}\text{C}$
Operation Mode	Cooling	Cooling	Soft Dry	Heating
FAN Speed	High	High	Soft Dry Rule	High
Setting Temp.	22 $^{\circ}\text{C}$	22 $^{\circ}\text{C}$	Air Intake Temperature	24 $^{\circ}\text{C}$