

This Owner's Manual is provided and hosted by [Appliance Factory Parts](#).

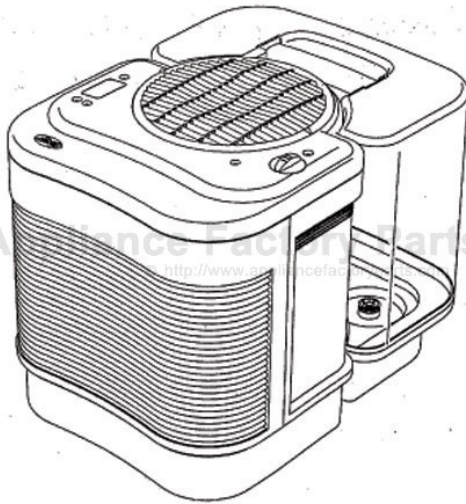

HUNTER 32305 Owner's Manual

[Shop genuine replacement parts for HUNTER 32305](#)



[Find Your HUNTER Humidifier Parts - Select From 99 Models](#)

----- Manual continues below -----



The Care Free[®] Humidifier Evaporative Humidifier

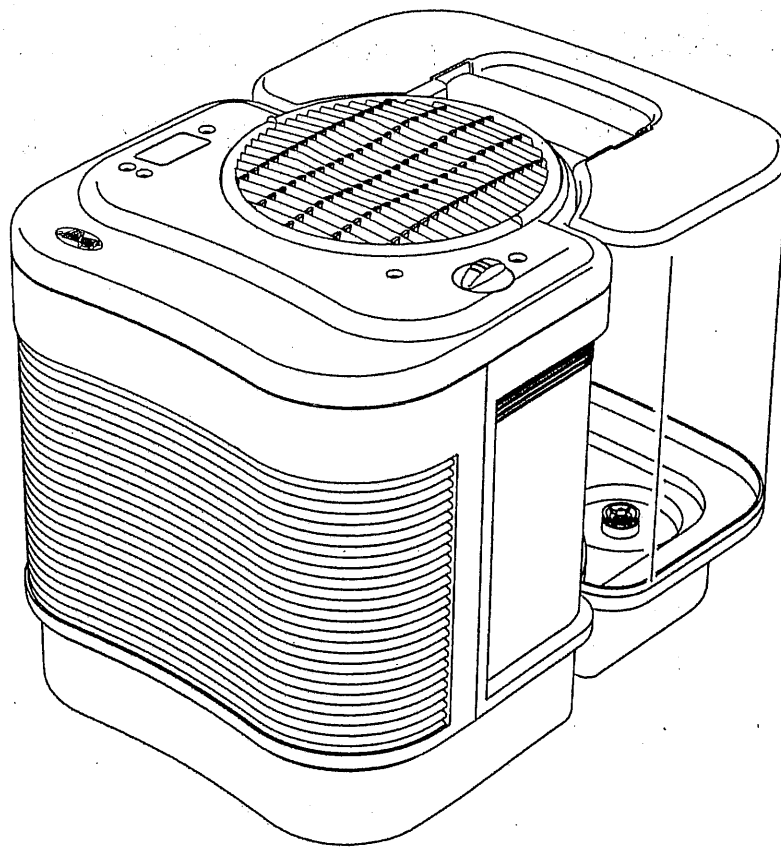

Features (Vary By Model):
NiteGlo™ Night Light
Digital Humidistat
Automatic Shut-Off

www.hunterfan.com

READ AND SAVE THESE INSTRUCTIONS

Important Safety Instructions:
Read all instructions before using this humidifier.

1. This humidifier may not work properly on an uneven surface. **ALWAYS** place this humidifier on a firm, level, and water resistant surface. **ALWAYS** place the humidifier at least six (6) inches away from walls and heat sources such as stoves, radiators, or heaters.
2. **ALWAYS** place the humidifier in an area that is out of the reach of children.
3. Before using the humidifier, extend the cord and inspect for any signs of damage. **DO NOT** use the product if the cord has been damaged.
4. This product has a polarized plug (one blade is wider than the other) as a safety feature. This plug will fit into a polarized outlet only one way. If the plug does not fit fully into the outlet, reverse the plug.

If it still does not fit, contact a qualified electrician. **DO NOT** attempt to defeat or override this safety feature.

5. **ALWAYS UNPLUG AND EMPTY** the humidifier when it is not in operation or while it is being cleaned.
6. **DO NOT** tilt or move the humidifier while it is in operation. Never move the humidifier while there is water in the tank. Empty the water tank, turn off, and unplug the unit before moving.
7. In addition to routine maintenance which may be required, this humidifier requires seasonal cleaning. Refer to and follow **CLEANING THE HUMIDIFIER AND THE WATER TANK** instructions.

Thank you for purchasing The Care Free® Humidifier Evaporative Humidifier by Hunter Fan Company. Please read and save these instructions to receive the maximum benefit and performance from your humidifier.

How The Care Free® Humidifier Evaporative Humidifier Works

The Care Free® Humidifier Evaporative Humidifier has a unique patented design with several innovative features:

- **Regulated Release™ System** – By dispersing water from the top of the filter, stagnant water around the filter is eliminated, and the buildup of mineral residue that can clog the filter and impede performance is eliminated.
- **Built-in Antimicrobial Properties** – The plastic parts and the filter have built-in antimicrobial properties to inhibit the growth of bacteria, mold and fungi that may affect these parts.

NOTE: This product contains antimicrobial properties which are built-in to inhibit the growth of bacteria which may affect the plastic and filter in the humidifier. These properties do not extend to the water, humidified air or users. Conduct routine cleaning and maintenance based upon use and individual conditions.

- **No White Dust** – The Care Free® Humidifier Evaporative Humidifier produces no white dust that can settle on furniture or be inhaled.

NOTE: You may notice mineral deposits accumulating in the tank base or on the filter. This is normal and does not affect

performance. If you would like to clean these deposits away, please see **CLEANING THE HUMIDIFIER AND WATER TANK.**

Humidifier Parts

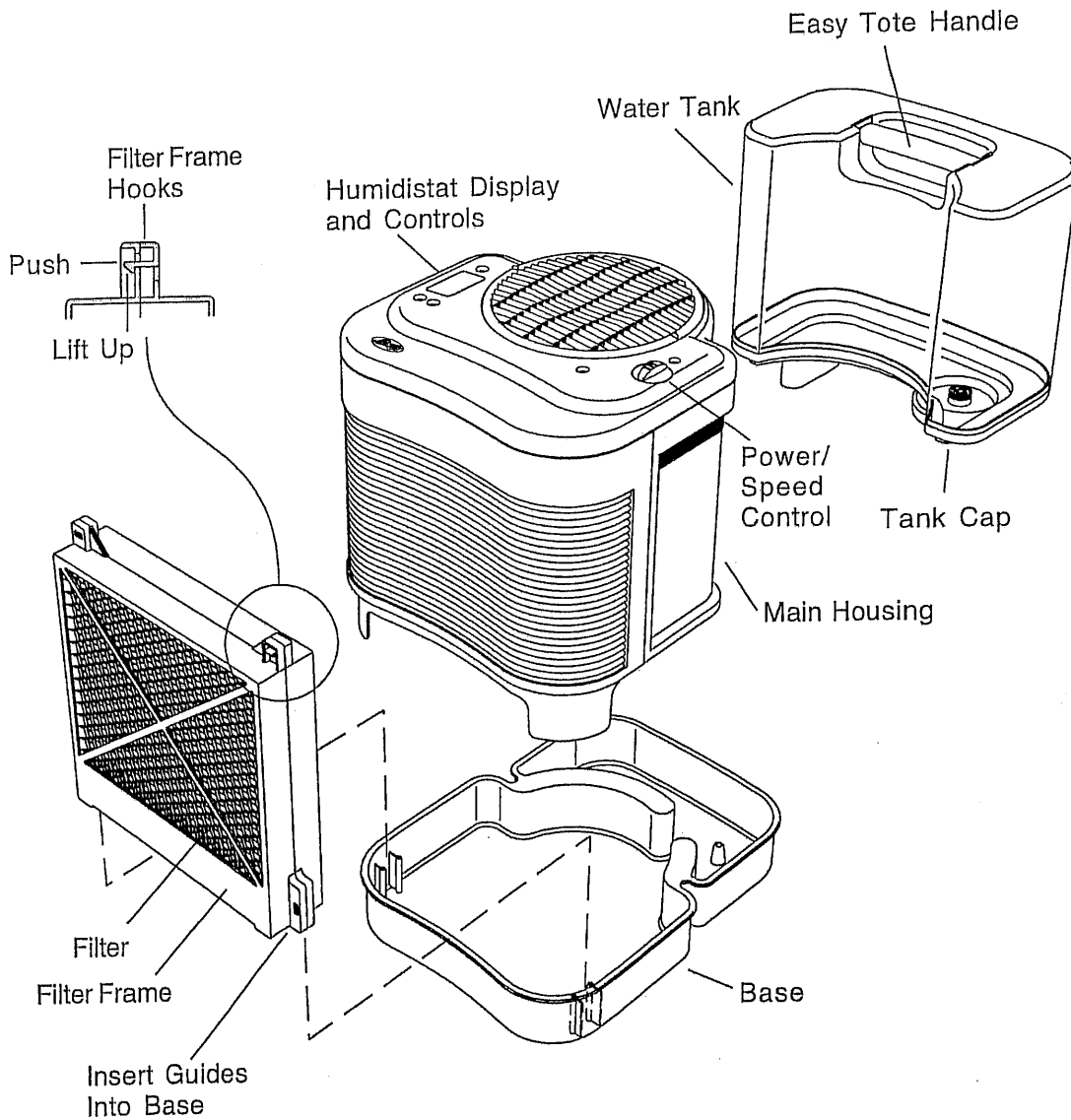

Figure 1

Humidifier Features

For Models 32305 & 32405

Power/Speed Control: Turns the humidifier 'ON' and 'OFF'. The power should always be off before unplugging the humidifier, moving the humidifier, or refilling the water tank.

Power Light: The red light will be illuminated when the power is on and the humidistat light is on.

Humidistat Display and Controls: Enables you to set desired maximum humidity level. Once this level is exceeded, the unit will shut off until the humidity level drops.

Note: The humidifier may not be running because the humidistat setting may need to be adjusted.

Humidistat Light: The green light will go off when the humidity in the room exceeds the level that you selected with the digital humidistat.

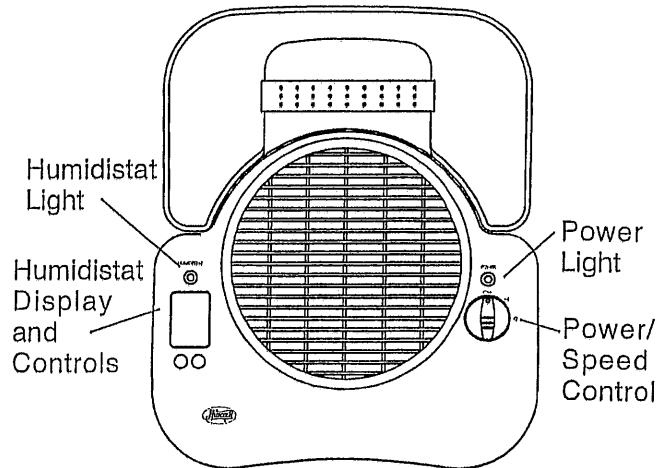

Figure 2

For Models 32307 & 32407

Power/Speed Control: Turns the humidifier 'ON' and 'OFF'. The power should always be off before unplugging the humidifier, moving the humidifier, or refilling the water tank.

Power Light: The red light will be illuminated when the power is on and the humidistat light is on.

Humidistat Display and Controls: Enables you to set desired maximum humidity level. Once this level is exceeded, the unit will shut off until the humidity level drops.

Note: The humidifier may not be running because the humidistat setting may need to be adjusted.

Humidistat Light: The green light will go off when the humidity in the room exceeds the level that you selected with the digital humidistat.

NiteGlo™ Night Light Control: Turns the night light 'ON' and 'OFF'. The night light can be turned on even if the humidifier fan is turned off.

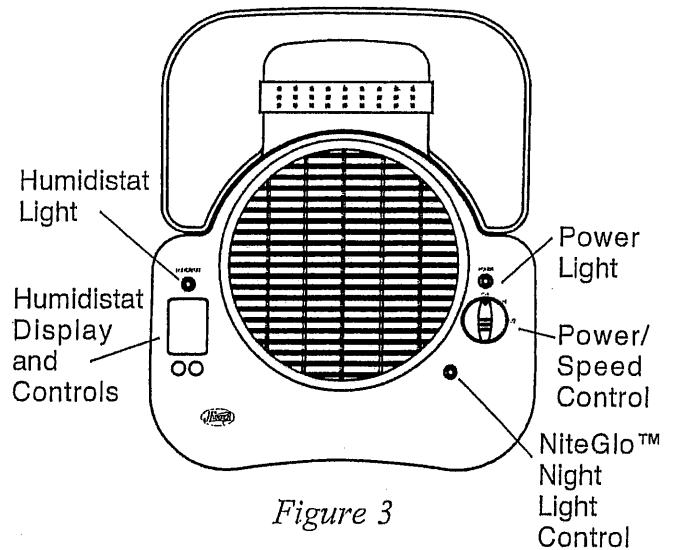

Figure 3

For Model 32505

Power/Speed Control: Turns the humidifier 'ON' and 'OFF'. The power should always be off before unplugging the humidifier, moving the humidifier, or refilling the water tank.

Refill Light: The red light will be illuminated to signal you that the humidifier has automatically turned off and the water tank needs to be refilled.

Humidistat Display and Controls: Enables you to set desired maximum humidity level. Once this level is exceeded, the unit will shut off until the humidity level drops.

Note: The humidifier may not be running because the humidistat setting may need to be adjusted.

Humidistat Light: The green light will go off when the humidity in the room exceeds the level that you selected with the digital humidistat.

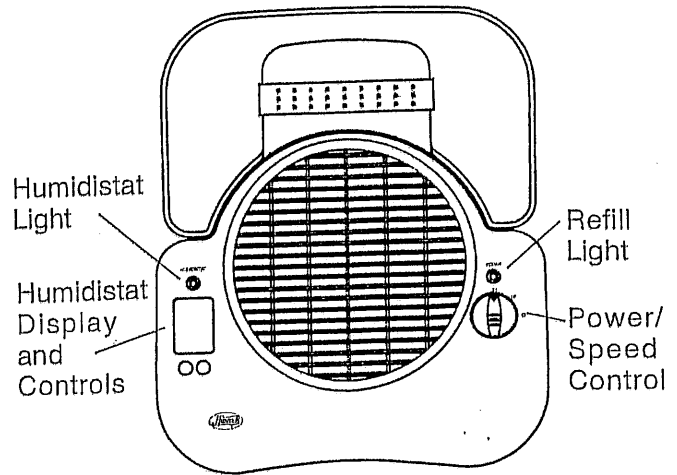

Figure 4

For Model 32507

Power/Speed Control: Turns the humidifier 'ON' and 'OFF'. The power should always be off before unplugging the humidifier, moving the humidifier, or refilling the water tank.

Refill Light: The red light will be illuminated to signal you that the humidifier has automatically turned off and the water tank needs to be refilled.

Humidistat Display and Controls: Enables you to set desired maximum humidity level. Once this level is exceeded, the unit will shut off until the humidity level drops.

Note: The humidifier may not be running because the humidistat setting may need to be adjusted.

Humidistat Light: The green light will go off when the humidity in the room exceeds the level that you selected with the digital humidistat.

NiteGlo™ Night Light Control: Turns the night light 'ON' and 'OFF'. The night light can be turned on even if the humidifier fan is turned off.

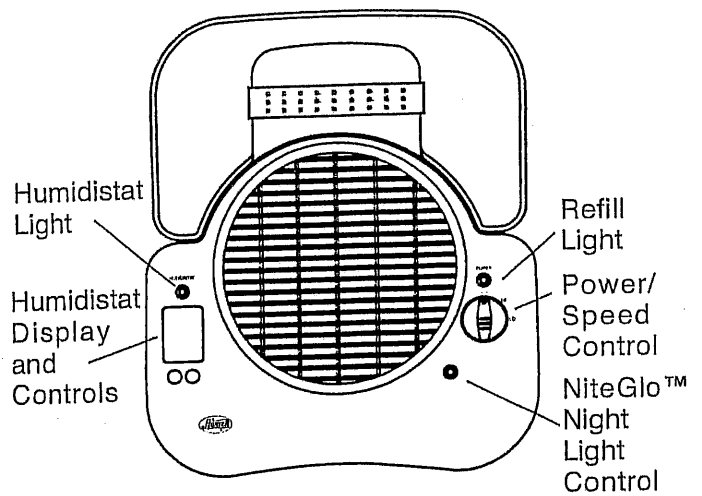

Figure 5

Using Your Humidifier

1. Remove The Care Free® Humidifier Evaporative Humidifier from its packaging. Read and Save the Instructions.
2. Place the humidifier on a hard, flat, water resistant surface. Always place the humidifier at least six (6) inches away from walls and sources of heat.
3. Lift the main housing to confirm that the filters are placed upright in the slots. Replace the main housing. (See Figure 1.)
4. Remove the water tank and take it to the sink or tub to fill.
5. Turn the tank upside down and unscrew the tank cap by turning it counterclockwise. Fill the water tank with cool water and replace the tank cap (Never use hot water). Be sure not to overfill the tank as water damage may occur to furniture or flooring due to spillage.

HUNTER WILL NOT ACCEPT RESPONSIBILITY FOR DAMAGE TO PROPERTY CAUSED BY WATER SPILLAGE.

6. Carry the tank back to the humidifier. Turn the tank upright and place it on the humidifier. Be sure that the tank is seated properly in the base. If the tank is properly located on the base, you will see air bubbles flowing up into the tank.
7. With the power control knob in the 'OFF' position, plug the humidifier into the wall.

CAUTION: Never plug in the Humidifier while your hands are wet as Electric Shock could occur.

8. Use the power/speed control knob to turn the humidifier 'ON' by selecting a speed setting.

Only for models with Automatic Shut-off

9. When the water tank is empty, the humidifier will automatically shut itself off. The red light will be illuminated, indicating that the water tank needs to be refilled.
10. Follow **REFILLING THE WATER TANK** directions. Once the water tank is refilled, the Refill Light will not be illuminated.

Only for models with a NiteGlo™ Night Light

11. Use the control to turn the night light off and on. The night light can be operated even if the humidifier fan is turned 'OFF'.

Using Your Digital Humidistat

Setting the Desired Humidity

Note: After unplugging the humidifier to move the humidifier, to refill the water tank or to clean the humidifier, you must reset the digital humidistat.

Refer to Figure 6.

1. Use the power/speed control knob to turn the humidifier 'ON' by selecting a speed setting.

Note: A speed setting must be chosen before the humidistat will operate the humidifier.

2. In normal mode use the humidistat control buttons to set the desired humidity level. The settings range from 30% to 80% in 5% increments.
3. When the humidity exceeds the level you have set, the humidistat light will go off. The humidifier will not output humidity while the humidity in the room is at the selected humidity level. The humidistat light will stay off until the humidity changes. When the humidity in the room drops below the selected level, the humidifier will cycle on again and the humidistat light will come on.

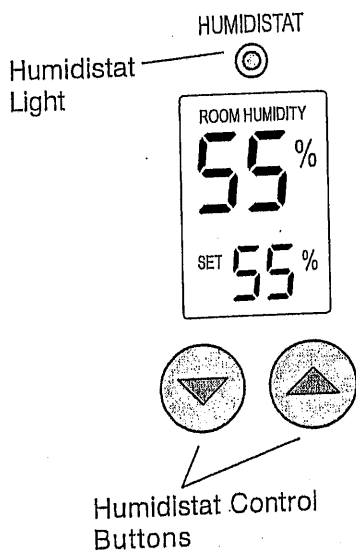

Figure 6

Setting the Span

Refer to Figure 7.

Your humidistat is set at the factory to cycle at setting 2. If you find your system cycling too fast or too slow, then the Span can be adjusted to modify the cycle time.

4. Press and hold both humidistat control buttons for two seconds to enter span setting mode.
5. In span mode, use the humidistat control buttons to adjust the span. Raise the span to 3 to increase the cycle time and allow your system to run longer. Lower the span to 1 to decrease the cycle time and allow your system to run shorter.
6. The humidistat display will return to normal mode after keys are idle for 5 seconds.

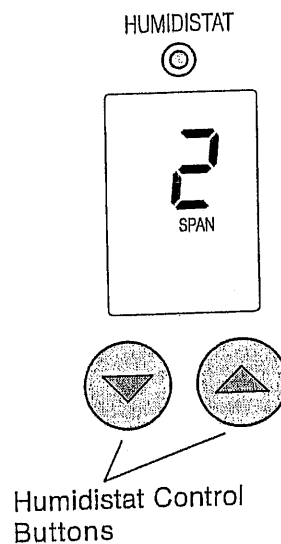

Figure 7

Refilling The Water Tank

1. When the water tank level is low, turn the humidifier 'OFF', and unplug.
2. Remove the tank and take it to the sink or tub to refill.
3. Turn the tank upside down and unscrew the tank cap by turning it counterclockwise. Empty the tank, refill with fresh cool water (never use hot water), and replace the tank cap. Be sure not to overfill the tank as water damage may occur to furniture or flooring due to spillage.

HUNTER WILL NOT ACCEPT RESPONSIBILITY FOR DAMAGE TO PROPERTY CAUSED BY WATER SPILLAGE.

4. Carry the tank back to the humidifier. Turn the tank upright and place it on the humidifier. Be sure that the tank is seated properly in the base. If the tank is properly located on the base, you will see air bubbles flowing up into the tank.

Cleaning The Humidifier And The Water Tank

Many regions have hard water with high concentrations of minerals. When water evaporates from The Care Free® Humidifier Evaporative Humidifier, minerals may be left behind. These minerals can form a hard white scale which can be removed by following the cleaning instructions. The frequency of cleaning due to mineral build up can vary depending upon the quality of water you may have.

Refer to **Figure 1** for part names.

1. Turn the humidifier 'OFF' and unplug the unit.
2. Lift the main housing and remove the water dispersion tray and the filters. **The motor is attached to the main housing. Do not place the motor near water. Do not use a wet towel on the motor or motor housing as electrical shock may occur.**
3. The filter should be cleaned in a vinegar and water solution to remove any mineral buildup. Place in a solution of one (1) gallon of water and eight (8) ounces of undiluted white vinegar. Allow the filter to soak for 20 minutes.
4. After soaking, rinse it several times with clean water. Place the filter in a location where it can drip dry while you clean the

other parts of your humidifier.

5. Remove the water tank from the base and empty any water that is left in the tank. Soak the base in a mixture of one (1) gallon of water and eight (8) ounces of vinegar for 20 minutes.
6. After soaking, wipe the base with a soft cloth or sponge to remove any mineral build up. Rinse with clean water several times. If you are planning on storing the humidifier, be sure the base is completely dry.
7. Fill the water tank with one (1) gallon of water and eight ounces of undiluted white vinegar. Replace the tank cap and shake the tank vigorously until all interior surfaces of the tank have been exposed to the water/vinegar mixture.
8. Empty the tank of the water/vinegar mixture. Rinse it several times with clean water and then replace the tank cap. If you are planning on storing the humidifier, dry it inside and out, leaving the cap off to allow the tank to completely dry. Continue to clean the other parts of your humidifier.
9. Remove the water diffuser cap and sponge. Rinse the sponge in clean water to remove any debris. If the sponge contains hard water residue, soak it in a mixture of

one (1) gallon of water and eight (8) ounces of vinegar for 20 minutes. Rinse well and reinstall sponge and diffuser cap in unit. **Do not expose motor or other electrical components to water.**

10. Wipe the surfaces of the main housing with a soft cloth.

11. Once all the parts are clean, reassemble the humidifier, and follow the **USING YOUR HUMIDIFIER** to continue use. **If you are storing the humidifier, make sure the parts are completely dry, reassemble, and store in a dry location.**

Service Parts

To obtain a service part for your humidifier, call customer service at 1-888-830-1326 or e-mail us at Techsupport@hunterfanhq.com. Please be prepared to tell the operator the model number of your humidifier and the name of the part you need to replace and the part number. Refer to Figure 1 for part names.

Model No.	Filter Frame	Base	Water Tank	Power/Speed Control	Tank Cap	Filter
32305	64171-04-000	92849-01-325	92851-01-326	64101-01-325	74079-01-325	31913
32307						31914
32405	64171-02-000	92850-01-325	92852-01-326	64101-01-325	74079-01-325	31915
32407						31915
32505	64171-03-000	92850-01-325	92852-01-326	64101-01-325	74079-01-325	31915
32507						31915

Hunter Fan Company

The Care Free® Humidifier Evaporative Humidifier

5 YEAR LIMITED WARRANTY

The Hunter Fan Company, Inc. makes the following warranty to the original residential user or consumer purchaser of The Care Free® Humidifier Evaporative Humidifier:

If any part of The Care Free® Humidifier Evaporative Humidifier ("Humidifier") motor fails during the first 5 (five) years from the date of installation due to a defect in material or workmanship, we will provide a replacement part free of charge. If no replacement part can be provided for such motor, we will replace your humidifier.

If your Humidifier motor fails any time within 1 (one) year after the date of installation due to a defect in material or workmanship, labor to repair the defect will be provided free of charge at our nearest service centre or at our Service Department in Memphis, Tennessee. You will be responsible for all parts and labor costs after this one-year period.

If your Humidifier water tank, filter frame, base, knobs, or tank cap fail any time within 1 (one) year after the date of sale to you due to a defect in material or workmanship, we will repair or, at our option, replace the water tank, filter frame, base, knobs, or tank cap free of charge for parts or labor performed at our nearest service centre or our Service Department in Memphis, Tennessee.

IF THE ORIGINAL RESIDENTIAL USER OR CONSUMER PURCHASER CEASES TO OWN THE HUMIDIFIER, THIS WARRANTY AND ANY IMPLIED WARRANTY WHICH THEN REMAINS IN EFFECT, INCLUDING BUT NOT LIMITED TO ANY IMPLIED WARRANTY OF MERCHANTABILITY OR FITNESS FOR A PARTICULAR PURPOSE, ARE VOIDED.

NO WARRANTY, EXPRESSED OR IMPLIED, INCLUDING ANY WARRANTY OF MERCHANTABILITY OR FITNESS FOR A PARTICULAR PURPOSE, IS MADE IN RESPECT TO THE FILTER.

THIS WARRANTY IS IN LIEU OF ALL OTHER EXPRESS WARRANTIES. THE DURATION OF ANY IMPLIED WARRANTY, INCLUDING BUT NOT LIMITED TO ANY IMPLIED WARRANTY OF MERCHANTABILITY OR FITNESS FOR A PARTICULAR PURPOSE, IN RESPECT TO THE MOTOR IS EXPRESSLY LIMITED TO THE PERIOD OF THE EXPRESS WARRANTY SET FORTH ABOVE.

This warranty is voided if your Humidifier is not purchased and used in the USA or Canada.

This warranty excludes and does not cover defects, malfunctions, or failures of the Humidifier which were caused by repairs by persons not authorized by us, use of parts, or accessories not authorized by us, mishandling, modifications, or damage to the Humidifier while in your possession, or unreasonable use, including failure to provide reasonable and necessary maintenance. This warranty does not cover humidifiers used in commercial applications. There are no express or implied warranties as to commercial purchasers or users.

To obtain service, contact the nearest Hunter authorized service centre or the Hunter Fan Company Service Department, 2500 Frisco Avenue, Memphis, Tennessee 38114, 901-248-2222. You will be responsible for insurance and freight or other transportation to our factory service center. We will return the Humidifier freight prepaid to you. The Humidifier should be properly packaged to

avoid damage in transit since we will not be responsible for any such damage. Proof of purchase is required when requesting warranty service. The purchaser must present the sales receipt or other document that establishes proof of purchase.

IN NO EVENT SHALL HUNTER FAN COMPANY BE LIABLE FOR DIRECT, INDIRECT, SPECIAL, CONSEQUENTIAL OR INCIDENTAL DAMAGES IN EXCESS OF THE PURCHASE PRICE OF THE HUMIDIFIER. YOUR SOLE REMEDY WILL BE REPAIR OR REPLACEMENT AS PROVIDED ABOVE.

SOME AMERICAN STATES AND CANADIAN PROVINCES DO NOT ALLOW

- LIMITATIONS ON HOW LONG AN IMPLIED WARRANTY LASTS;
- THE EXCLUSION OR LIMITATION OF DIRECT, INDIRECT, SPECIAL, INCIDENTAL OR CONSEQUENTIAL DAMAGES;
- THE EXCLUSION OR INVALIDITY OF EXPRESS OR IMPLIED WARRANTIES IF THE USER CEASES TO OWN THE HUMIDIFIER;

- THE LIMITATION OF THE REMEDIES AND RECOURSES AVAILABLE TO THE PURCHASER; OR
- THE INVALIDITY OF AN EXPRESS WARRANTY WHEN A PRODUCT IDENTIFIED BY BRAND NAME IS NOT USED (UNLESS SPECIFIC CONDITIONS ARE FULFILLED);

SO THE ABOVE LIMITATIONS OR EXCLUSIONS MAY NOT APPLY TO YOU.

THIS WARRANTY GIVES YOU SPECIFIC LEGAL RIGHTS AND YOU MAY ALSO HAVE OTHER RIGHTS WHICH VARY FROM STATE TO STATE OR PROVINCE TO PROVINCE.

HUNTER FAN COMPANY
2500 FRISCO AVENUE
MEMPHIS, TN 38114, USA



Other Home Comfort Products from Hunter

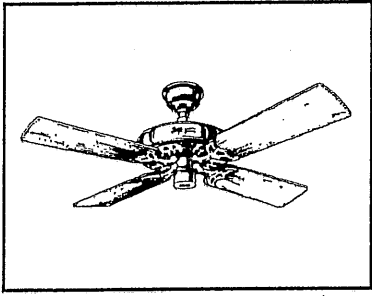

Hunter Original®

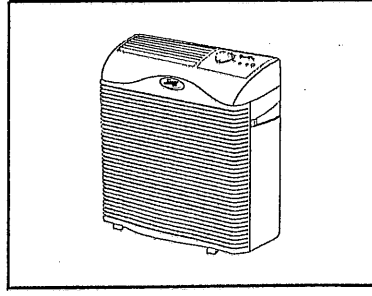

QuietFlo™
True HEPA Air
Purifier

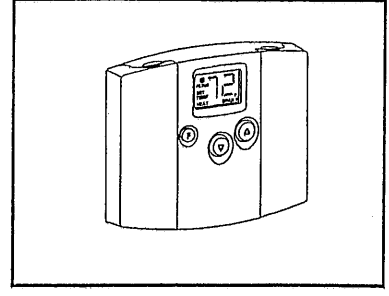

Programmable
Thermostat

To learn more about Hunter Fan Company products, please see our web page at:
www.hunterfan.com