



Dehumidifiers

Safety Instructions 2, 3

Operating Instructions

About the Controls
on the Dehumidifier 4
Automatic Defrost 5
Choosing a Location 5
How the Dehumidifier Operates ... 5
Installing the Water Bucket 6
Removing Collected Water 6
Water Level 6

Care and Cleaning

Air Filter 7
Cleaning the Coil 7
Grille and Case 7
Water Bucket 7

Troubleshooting Tips 8

Consumer Support

Consumer Support 12
Product Registration 9, 10
Warranty 11

*ENERGY STAR® labeled product



As an ENERGY STAR® partner, GE has determined that this product meets the ENERGY STAR® guidelines for energy efficiency.

Write the model and serial numbers here:

Model # _____

Serial # _____

You can find them on a label on the back of the dehumidifier behind the bucket.

Owner's Manual

AHG30LH
AHG40LH*
AHG50LH*



IMPORTANT SAFETY INFORMATION. READ ALL INSTRUCTIONS BEFORE USING.

⚠ WARNING!

For your safety, the information in this manual must be followed to minimize the risk of fire, electric shock or personal injury.



SAFETY PRECAUTIONS

When using this dehumidifier, always follow basic safety precautions, including the following:

- Use this appliance only for its intended purpose as described in this Owner's Manual.
 - **This dehumidifier must be properly installed and grounded as described in this manual before it is used.**
 - **Never operate this dehumidifier in an area that is likely to accumulate standing water.** If this condition develops, for your safety disconnect the power supply before stepping into the water.
 - Never unplug your dehumidifier by pulling on the power cord. Always grip plug firmly and pull straight out from the receptacle.
 - **Repair or replace immediately all electric service cords** that have become frayed or otherwise damaged. Do not use a cord that shows cracks or abrasion damage along its length or at either the plug or connector end.
 - Turn the dehumidifier **OFF** and unplug it before making any repairs or cleaning.
- NOTE:** We strongly recommend that any servicing be performed by a qualified individual.
- For your safety, do not store or use combustible materials, gasoline or other flammable vapors or liquids in the vicinity of this or any other appliance.
 - All dehumidifiers contain refrigerants, which under federal law must be removed prior to product disposal. If you are getting rid of an old product with refrigerants, check with the company handling disposal about what to do.



HOW TO CONNECT ELECTRICITY

Do not, under any circumstances, cut or remove the third (ground) prong from the power cord. For personal safety, this appliance must be properly grounded.

The power cord of this appliance is equipped with a 3-prong (grounding) plug which mates with a standard 3-prong (grounding) wall outlet to minimize the possibility of electric shock hazard from this appliance.

Have the wall outlet and circuit checked by a qualified electrician to make sure the outlet is properly grounded.

Where a 2-prong wall outlet is encountered, it is your personal responsibility and obligation to have it replaced with a properly grounded 3-prong wall outlet.

The dehumidifier should always be plugged into its own individual electrical outlet, which has a voltage rating matching the rating plate.

This provides the best performance and also prevents overloading house wiring circuits, which could cause a fire hazard from overheated wires.



USE OF EXTENSION CORDS

Because of potential safety hazards under certain conditions, we strongly recommend against the use of an extension cord.

However, if you must use an extension cord, it is absolutely necessary that it be a UL-listed, 14 gauge, 3-wire grounding type appliance extension cord having a grounding type plug and outlet and that the electrical rating of the cord be 15 amperes (minimum) and 125 volts.



USE OF ADAPTER PLUGS

Because of potential safety hazards under certain conditions, we strongly recommend against the use of an adapter plug.

However, if you must use an adapter, where local codes permit, a **temporary connection** may be made to a properly grounded 2-prong wall outlet by use of a UL-listed adapter available at most local hardware stores.

The larger slot in the adapter must be aligned with the larger slot in the wall outlet to provide proper polarity in the connection of the power cord.

When disconnecting the power cord from the adapter, always hold the adapter in place with one hand while pulling the power cord plug with the other hand. If this is not done, the adapter ground terminal is very likely to break with repeated use.

If the adapter ground terminal breaks, **DO NOT USE** the dehumidifier until a proper ground has been established.

Attaching the adapter ground terminal to a wall outlet cover screw does not ground the appliance unless the cover screw is metal, not insulated, and the wall outlet is grounded through the house wiring. You should have the circuit checked by a qualified electrician to make sure the outlet is properly grounded.



READ AND FOLLOW THIS SAFETY INFORMATION CAREFULLY.

SAVE THESE INSTRUCTIONS

About the controls on the dehumidifier.

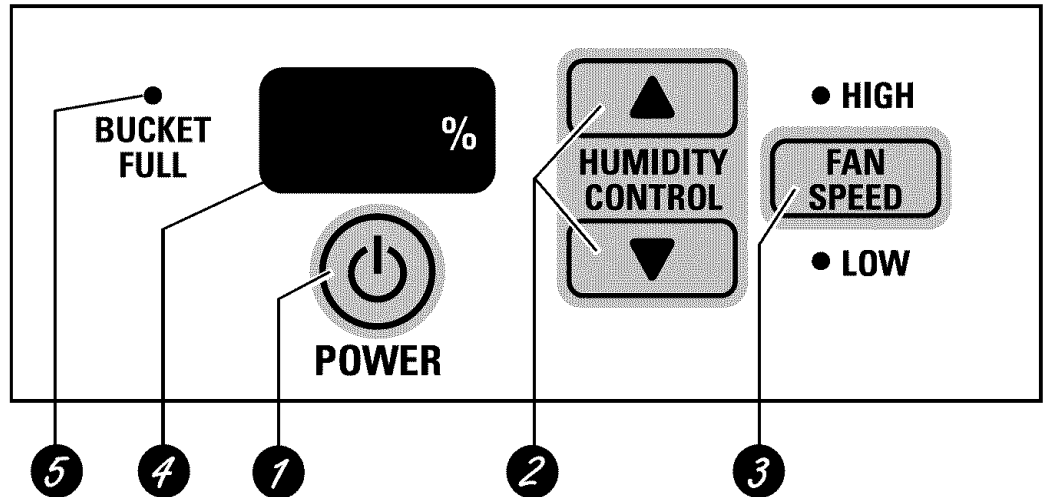

Controls

1 POWER Pad

Press to turn the dehumidifier on and off.

2 HUMIDITY CONTROL Pads

The humidity level can be set within a range of 35% RH (Relative Humidity) to 70% RH (Relative Humidity) in 5% increments.

For drier air, press the ▼ pad and set to a lower percent value (%).

For damper air, press the ▲ pad and set to a higher percent value (%).

When you first use the dehumidifier, set the humidity control to 45% or 50%. Allow at least 24 hours for the dehumidifier to achieve the humidity level. If you still have damper air than desired, set the humidity level to a lower setting.

3 FAN SPEED Pad

Controls the fan speed.

Press to set to **HIGH** or **LOW** fan speed.

Set the fan control to **HIGH** for maximum moisture removal. When the humidity has been reduced and quiet operation is preferred, set the fan control to **LOW**.

4 HUMIDITY LEVEL DISPLAY

Displays percent humidity level. Its accuracy is (+/- 5%).

5 BUCKET FULL LED

Indicates presence of bucket and its fill level.

Other Features

BUCKET FULL Light

Glow when the bucket is ready to be emptied, or when the bucket is removed or not replaced in the proper position.

Auto Shut Off

The Water Level Control Switch shuts off the dehumidifier when the bucket is full, or when the bucket is removed or not replaced in the proper position. Also, when the bucket is out of position, the unit will beep 3 times.

Auto Defrost

When frost builds up on the cooling coils, the compressor will cycle off until the frost disappears. The fan continues to run.

Power Outage

If a power outage occurred or if the unit was unplugged, the unit will display its prior setting. **Note:** If **ON** is in the display, the dehumidifier is operating continuously, but a specific humidity level is not set. You will need to reset the **HUMIDITY CONTROL** to the desired level.

Auto Restart

Once power is restored after a power outage, the unit automatically resumes operation after a 2 minute delay.

When first using the dehumidifier, operate the unit continuously 24 hours.

How the Dehumidifier Operates

Moist, humid air is drawn over a cold refrigerated dehumidifying coil. Moisture in the air condenses on this coil and drains into a bucket (or through the bucket into a hose and drain).

Dry, clean air is drawn through the condenser where it is heated and discharged out the front grille into the room.

It is normal for the surrounding air to become slightly warmer as the dehumidifier operates.

This warming effect further reduces the relative humidity of the surrounding air.

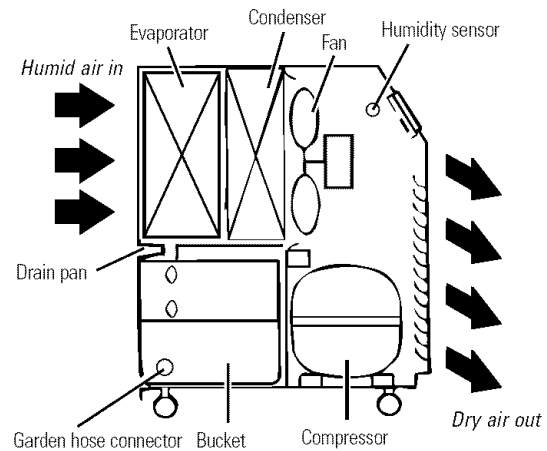

Choosing a Location

A dehumidifier operating in a basement will have little or no effect in drying an adjacent enclosed storage area, such as a closet, unless there is adequate circulation of air in and out of the area.

- Place the dehumidifier on a smooth, level floor strong enough to support the unit with a full bucket of water.
- Allow at least 12–18 inches of air space on all sides of the unit for good air circulation.
- Place the dehumidifier in an area where the temperature will not fall below 65°F (18°C). The coils can become covered with frost at temperatures below 65°F, which may reduce performance.
- Use the dehumidifier in cooking, laundry, bathing and dishwashing areas that have excessive moisture. **NOTE:** Place the dehumidifier away from the clothes dryer.
- Use the dehumidifier to prevent moisture damage anywhere books or valuables are stored.
- Use the dehumidifier in a basement to help prevent moisture damage.
- The dehumidifier must be operated in an enclosed area to be most effective.
- Close all doors, windows and other outside openings to the room.

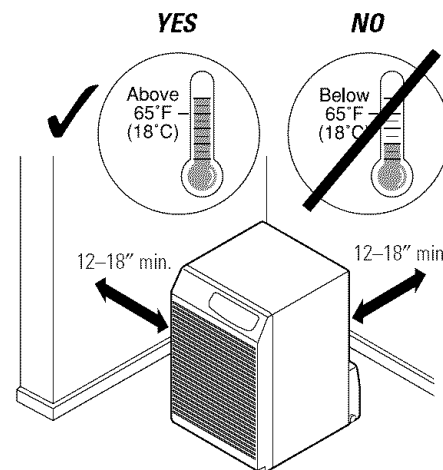

NOTE: The dehumidifier has rollers to aid placement, but it should only be rolled on smooth, flat surfaces. Do not attempt to roll the dehumidifier on carpet or over objects.

Automatic Defrost

When the dehumidifier control senses frost buildup on the evaporator coil, it will automatically shut off the compressor. The fan will continue to run to draw air across the coil and melt the frost.

When the coil is defrosted, the compressor will automatically restart and dehumidifying will resume.

Using the dehumidifier.

Always make sure the water bucket is locked into place on the dehumidifier.

Removing Collected Water

There are 3 ways to remove collected water:

- 1 **Use the bucket.** When the bucket is removed, the unit will shut off. Empty and replace the bucket.

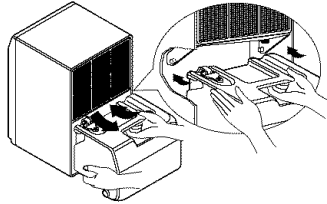

- 2 **Use a hose.** Water can be automatically emptied into a floor drain by attaching a water hose (not included) to the bucket hose nozzle. Using a drill, make a hole at the end of the nozzle located on the lower left side of the bucket. Attach a water hose to the bucket nozzle. Fasten by hand only.

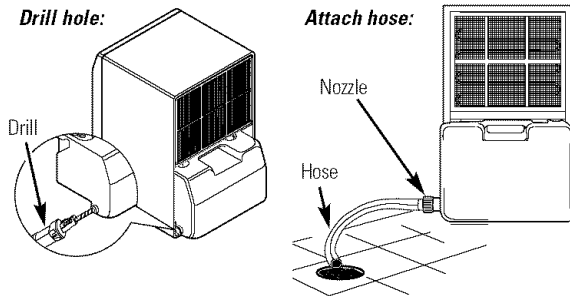

- 3 **Use a floor drain.** The unit can also be placed over a floor drain. Using a drill, make a hole at the end of the nozzle located on the lower left side of the bucket.

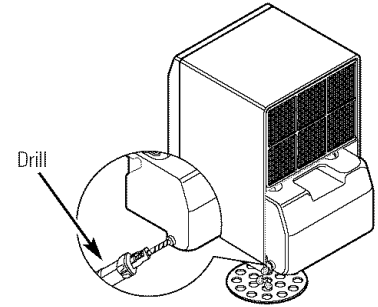

NOTE: The nozzle cannot be fixed after puncture. Use an ordinary garden hose cap (not included) to reclose if necessary.

NOTE: Avoid using mechanical tools to tighten the water hose to the bucket nozzle. This may damage the threads on the nozzle.

Installing the Water Bucket

Lift the bucket and hook the slots on each side onto the posts on the back of the dehumidifier. The bucket should lock securely in place.

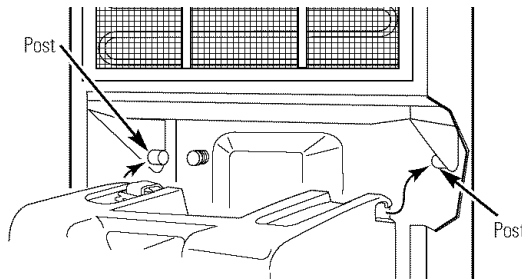

Make sure the bucket is locked securely in place by pressing down on the upper back edge of the bucket. It will be firmly seated when properly installed.

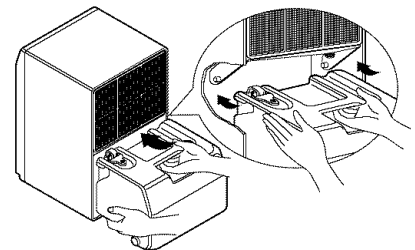

Water Level

The dehumidifier will turn off automatically when the bucket is full, or when the bucket is removed or not replaced in the proper position.

The bucket must be replaced in the proper position for the dehumidifier to work. The light will be on and the dehumidifier will not run if the bucket is not in the proper position.

Turn the dehumidifier off and remove the plug from the wall outlet before cleaning.

Grille and Case

To clean the case:

Use water and a mild detergent. Do not use bleach or abrasives.

If cabinet paint chips, you can touch it up with a good grade enamel paint to prevent rust.

To clean the front grille:

Use a vacuum attachment or brush.

Air Filter

The air filter is on the back of the dehumidifier. **It should be checked and cleaned at least every 30 days or more often if necessary.**

NOTE: DO NOT rinse or put the filter in an automatic dishwasher.

CAUTION: DO NOT operate the dehumidifier without the filter because dirt and lint will clog it and reduce performance.

To remove:

Flex the filter at the lower right corner and slide the upper right side to the left. Release all of the tabs and remove the filter. Wash it in warm soapy water. Rinse and let the filter dry before replacing it.

To replace:

Hold the filter with the middle tab at the top and place the bottom of the filter in the filter hook. Slide the side filter tabs into the side slots and press the other three tabs into their slots.

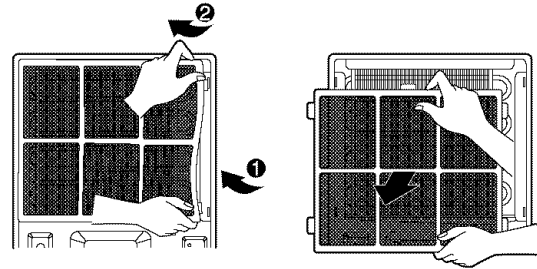

NOTE: Avoid using a dishwasher to clean the filter.

Cleaning the Coil

After removing the air filter, clean the coil with a soft brush when the soil is soft and wet.

NOTE: Do not allow water to enter the electrical/machine compartment through the circular opening behind the coil.

Do not spray the coil with a hose.

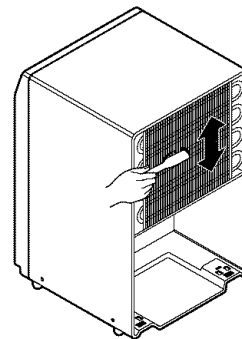

Water Bucket

Every few weeks, rinse the inside of the water bucket with a mild detergent to prevent growth of mold, mildew and bacteria.

NOTE: Avoid using a dishwasher to clean the water bucket.

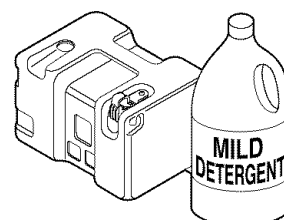

Before you call for service...



Troubleshooting Tips

Save time and money! Review the chart below first and you may not need to call for service.

Problem	Possible Causes	What To Do
Dehumidifier does not start	The dehumidifier is unplugged.	• Make sure the dehumidifier's plug is pushed completely into the outlet.
	The fuse is blown/circuit breaker is tripped.	• Check the house fuse/circuit breaker box and replace the fuse or reset the breaker.
	Dehumidifier has reached its preset level or bucket is full.	• The dehumidifier automatically turns off when this occurs. Empty the bucket and replace properly.
	Bucket is not in the proper position.	• See the <i>Installing the Water Bucket</i> section.
Dehumidifier does not dry the air as it should	Did not allow enough time to remove the moisture.	• When first installed, allow at least 24 hours to maintain the desired dryness.
	Airflow is restricted.	• Make sure there are no curtains, blinds or furniture blocking the front or back of the dehumidifier. See the <i>Choosing a Location</i> section.
	The Humidity Control may not be set low enough.	• Press the Humidity Control ▼ pad to lower the humidity setting.
	Doors and windows may not be closed tightly.	• Check that all doors, windows and other openings are securely closed.
	Clothes dryer may be blowing moisture-laden air into the room.	• Install the dehumidifier away from the dryer. The dryer should be vented to the outside.
	Room temperature is too low.	• Moisture removal is best at higher room temperatures. Lower room temperatures will reduce the moisture removal rate. This unit is designed to be operated at temperatures above 65°F (18°C).
Dehumidifier runs too much	Area to be dehumidified is too large.	• Refer to the chart below to see if the capacity of your dehumidifier is adequate.
	Doors and windows are open.	• Close all doors and windows to the outside.
Frost appears on the coils	Dehumidifier has been recently turned on or room temperature is below 65°F (18°C).	• This is normal. Frost will usually disappear within 60 minutes. See the <i>Automatic Defrost</i> section.
Fan noise	Air is moving through the dehumidifier.	• This is normal.
Water on floor	Bucket drain hose connection may be loose.	• Check the hose if one is attached.
	Water bucket is not all of the way in.	• See the <i>Installing the Water Bucket</i> section.

What dehumidifier do you need?

Condition without dehumidification—

During warm and humid outdoor conditions

Moderately damp—Space feels damp and has musty odor only in humid weather.

Very damp—Space always feels damp and has musty odor. Damp spots show on walls or floor.

Wet—Space feels and smells wet. Walls or floor sweat, or seepage is present.

Extremely wet—Laundry drying, wet floor, high-load conditions

	Area (in square feet)					
	500	1000	1500	2000	2500	3000
Moderately damp —Space feels damp and has musty odor only in humid weather.	AHG30	AHG30	AHG30	AHG30	AHG40	AHG40
Very damp —Space always feels damp and has musty odor. Damp spots show on walls or floor.	AHG30	AHG30	AHG30	AHG40	AHG40	AHG40
Wet —Space feels and smells wet. Walls or floor sweat, or seepage is present.	AHG30	AHG30	AHG40	AHG40	AHG40	AHG50
Extremely wet —Laundry drying, wet floor, high-load conditions	AHG30	AHG30	AHG40	AHG40	AHG50	AHG50

GE Service Protection Plus™

GE, a name recognized worldwide for quality and dependability, offers you Service Protection Plus™—comprehensive protection on all your appliances—**No Matter What Brand!**

Benefits Include:

- Backed by GE
- All brands covered
- Unlimited service calls
- All parts and labor costs included
- No out-of-pocket expenses
- No hidden deductibles
- One 800 number to call

***We'll Cover Any Appliance.
Anywhere. Anytime.****

You will be completely satisfied with our service protection or you may request your money back on the remaining value of your contract. No questions asked. It's that simple.

Protect your refrigerator, dishwasher, washer and dryer, range, TV, VCR and much more—**any brand!** Plus there's no extra charge for emergency service and low monthly financing is available. Even icemaker coverage and food spoilage protection is offered. You can rest easy, knowing that all your valuable household products are protected against expensive repairs.

Place your confidence in GE and call us in the U.S. toll-free at **800.626.2224** for more information.

*All brands covered, up to 20 years old, in the continental U.S.

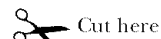

Please place in envelope and mail to:

General Electric Company
Warranty Registration Department
P.O. Box 32150
Louisville, KY 40232-2150

Consumer Product Ownership Registration

Dear Customer:

Thank you for purchasing our product and thank you for placing your confidence in us. We are proud to have you as a customer!

Follow these three steps to protect your new appliance investment:

1 Complete and mail your Consumer Product Ownership Registration today. Have the peace of mind of knowing we can contact you in the unlikely event of a safety modification.

2 After mailing the registration below, store this document in a safe place. It contains information you will need should you require service. Our service number is 800.GE.CARES (800.432.2737).

3 Read your Owner's Manual carefully. It will help you operate your new appliance properly.

Model Number

Serial Number

Important: If you did not get a registration card with your product, detach and return the form below to ensure that your product is registered, or register online at GEAppliances.com.

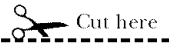

Consumer Product Ownership Registration



Model Number

Serial Number

Mr. Ms. Mrs. Miss

First Name _____

Last Name _____

Street Address _____

Apt. # _____

E-mail Address* _____

City _____

State _____

Zip Code _____

Date Placed In Use
Month _____

Day _____

Year _____

Phone Number _____-_____-_____



GE Appliances

GE Consumer & Industrial
Louisville, Kentucky
www.GEAppliances.com

* Please provide your e-mail address to receive, via e-mail, discounts, special offers and other important communications from GE Appliances (GEA).

Check here if you do not want to receive communications from GEA's carefully selected partners.

FAILURE TO COMPLETE AND RETURN THIS CARD DOES NOT DIMINISH YOUR WARRANTY RIGHTS.

For information about GEA's privacy and data usage policy, go to www.GEAppliances.com and click on "Privacy Policy" or call 800.626.2224.

Dehumidifier Warranty.



All warranty service provided by our Factory Service Centers, or an authorized Customer Care® technician. To schedule service, on-line, 24 hours a day, visit us at GEAppliances.com, or call 800.GE.CARES (800.432.2737).

Staple your receipt here. Proof of the original purchase date is needed to obtain service under the warranty.

For The Period Of:	We Will Replace:
One Year From the date of the original purchase	Any part of the dehumidifier which fails due to a defect in materials or workmanship. During this full one-year warranty , GE will also provide, free of charge , all labor and in-home service to replace the defective part.
Five Years From the date of the original purchase	The compressor if it should fail due to a defect in materials or workmanship. During this five-year warranty , GE will also provide, free of charge , all labor and in-home service to repair or replace the compressor.

What Is Not Covered:

- Service trips to your home to teach you how to use the product.
- Improper installation, delivery or maintenance. If you have an installation problem, or if the dehumidifier is of improper dehumidifying capacity, contact your dealer or installer. You are responsible for providing adequate electrical, plumbing and other connecting facilities.
- Failure of the product resulting from modifications to the product or due to unreasonable use including failure to provide reasonable and necessary maintenance.
- In commercial locations labor necessary to move the unit to a location where it is accessible for service by an individual technician.
- Replacement of house fuses or resetting of circuit breakers.
- Failure due to corrosion on models not corrosion-protected.
- Damage to the product caused by improper power supply voltage, accident, fire, floods or acts of God.
- Incidental or consequential damage caused by possible defects with this dehumidifier.
- Damage caused after delivery.

This warranty is extended to the original purchaser and any succeeding owner for products purchased for home use within the USA. In Alaska, the warranty excludes the cost of shipping or service calls to your home.

Some states do not allow the exclusion or limitation of incidental or consequential damages. This warranty gives you specific legal rights, and you may also have other rights which vary from state to state. To know what your legal rights are, consult your local or state consumer affairs office or your state's Attorney General.

Warrantor: General Electric Company, Louisville, KY 40225

Consumer Support



GE Appliances Website

GEAppliances.com

Have a question or need assistance with your appliance? Try the GE Appliances Website 24 hours a day, any day of the year! For greater convenience and faster service, you can now download Owner's Manuals, order parts, catalogs, or even schedule service on-line. You can also "Ask Our Team of Experts™" your questions, and so much more...

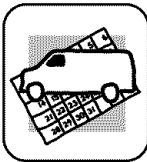

Schedule Service

GEAppliances.com

Expert GE repair service is only one step away from your door. Get on-line and schedule your service at your convenience 24 hours any day of the year! Or call 800.GE.CARES (800.432.2737) during normal business hours.

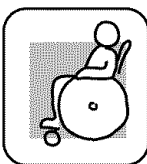

Real Life Design Studio

GEAppliances.com

GE supports the Universal Design concept—products, services and environments that can be used by people of all ages, sizes and capabilities. We recognize the need to design for a wide range of physical and mental abilities and impairments. For details of GE's Universal Design applications, including kitchen design ideas for people with disabilities, check out our Website today. For the hearing impaired, please call 800.TDD.GEAC (800.833.4322).



Extended Warranties

GEAppliances.com

Purchase a GE extended warranty and learn about special discounts that are available while your warranty is still in effect. You can purchase it on-line anytime, or call 800.626.2224 during normal business hours. GE Consumer Home Services will still be there after your warranty expires.

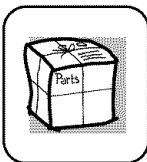

Parts and Accessories

GEAppliances.com

Individuals qualified to service their own appliances can have parts or accessories sent directly to their homes (VISA, MasterCard and Discover cards are accepted). Order on-line today, 24 hours every day or by phone at 800.626.2002 during normal business hours.

Instructions contained in this manual cover procedures to be performed by any user. Other servicing generally should be referred to qualified service personnel. Caution must be exercised, since improper servicing may cause unsafe operation.



Contact Us

GEAppliances.com

If you are not satisfied with the service you receive from GE, contact us on our Website with all the details including your phone number, or write to: General Manager, Customer Relations
GE Appliances, Appliance Park
Louisville, KY 40225



Register Your Appliance

GEAppliances.com

Register your new appliance on-line—at your convenience! Timely product registration will allow for enhanced communication and prompt service under the terms of your warranty, should the need arise. You may also mail in the pre-printed registration card included in the packing material.