

This Owner's Manual is provided and hosted by Appliance Factory Parts.

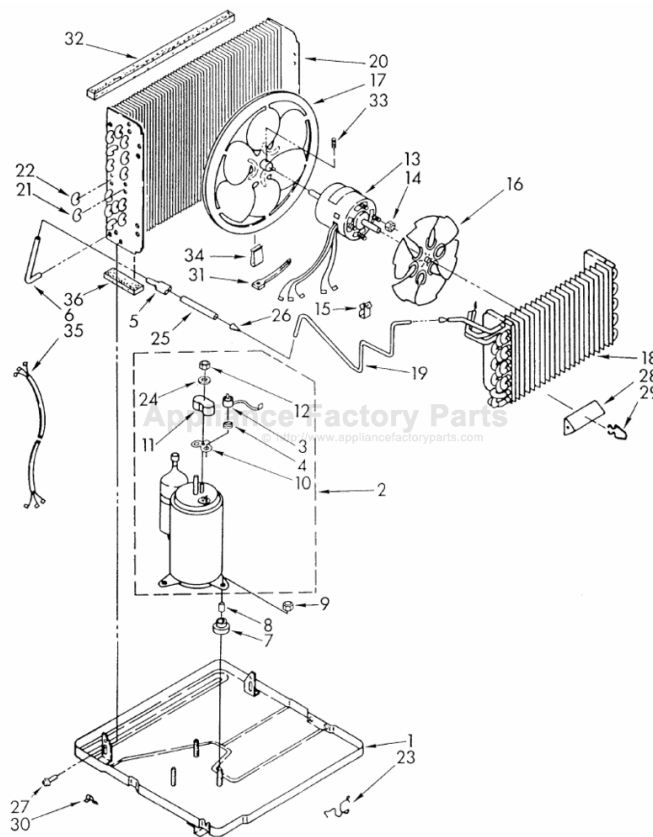

ROPER X12002V0 Owner's Manual

[Shop genuine replacement parts for ROPER X12002V0](#)



[Find Your ROPER Air Conditioner Parts - Select From 49 Models](#)

----- Manual continues below -----

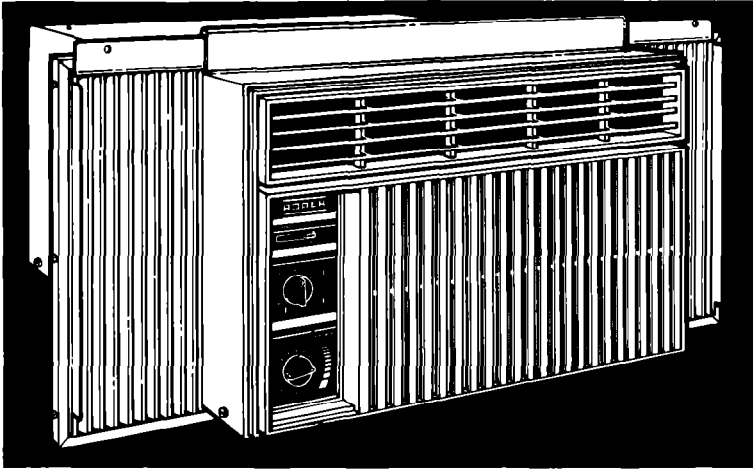

Models
 X05002V0
 X05002W0
 X07502V0
 X07002W0
 X10002V1
 X10002W0
 X12002V0

Air Conditioner Use and Care Guide



Appliances

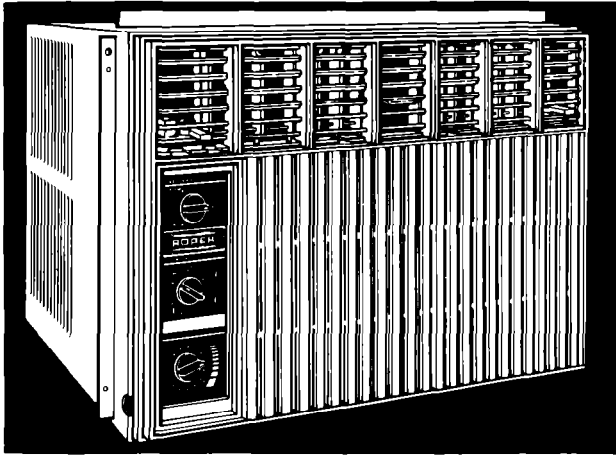

Model
 X18004V0

Thank you for choosing a Roper air conditioner. This Guide will help you operate and maintain your new, quality-built Roper air conditioner. Keep this Guide in a safe place for future reference.

First...complete all of the Installation Instruction

steps before attempting to operate your air conditioner.

Next...complete and mail the Product Registration Card.

This card enters your warranty into our

warranty system insuring efficient claim processing. It can be used as a proof of purchase for insurance claims and helps Roper to contact you immediately in the unlikely event of a product safety recall.

Please remember...

It is your responsibility to be sure that your air conditioner:

- Has been properly installed according to the Installation Instructions provided.
- Is the right size for the area you want to cool.
- Is properly connected to a grounded electrical circuit that meets the electrical requirements as stated in the Installation Instructions.

- Is used only for the job it was intended to do.
- Is not used by children or anyone unable to operate it properly.
- Is properly maintained.

Remove the energy label.

Lift one edge of the energy rating label and pull straight off. Use a damp cloth to take off any glue residue.

Do Not use any sharp instrument or any harsh or abrasive cleaners.

Do Not use rubbing alcohol or flammable toxic solvents; such as acetone, gasoline, carbon tetrachloride, etc.

Energy-saving tips.

- Improve home insulation. Seal doors and windows. Close fireplace flue.
- Close blinds or drapes on sunny side of house. Add window awnings.
- Keep air filter clean.
- Do Not block air flow with drapes or furniture.
- Ventilate attic. High temperatures in the attic add to the cooling load.
- Try not to use heat-producing appliances during the hottest part of the day.
- Turn lights and appliances off when not needed.
- Keep heat registers and cool-air returns closed.
- Use exhaust venting fans while cooking, doing laundry and bathing.

Important Safety Instructions

⚠ WARNING

Reduce risk of fire, electrical shock or personal injury when using air conditioner by following these basic precautions:

- Complete all of the Installation Instructions to prevent product operating problems and possible personal injury.
- Read all operating instructions before using air conditioner.
- Do Not store or use gasoline or other flammable vapors and liquids in the vicinity of this or any other appliance. The fumes can create fire hazard or explosion.
- Use only a properly grounded electrical outlet. Check with a qualified electrician if you are in doubt as to whether the air conditioner is properly grounded. Do Not modify the plug on the power cord. If it will not fit the outlet, have a proper outlet installed by a qualified electrician.
- Do Not use an extension cord.
- Do Not have a fuse in the neutral or grounding circuit.

Save these instructions

Starting your air conditioner.

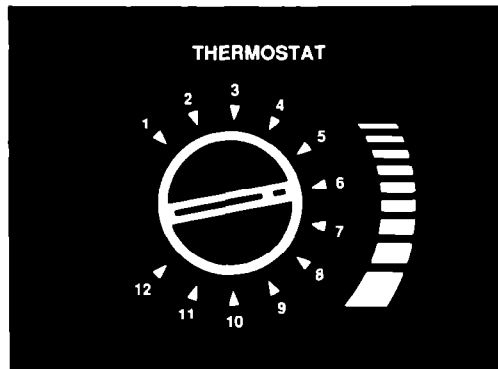
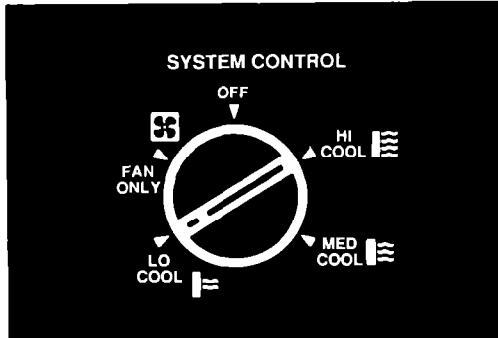
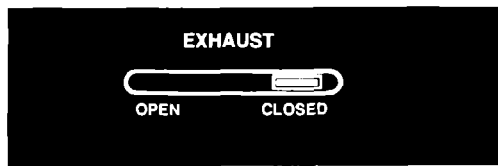

1. Set the Exhaust Control* to the "Closed" position or the Air Control to the "Off" position depending on which feature your air conditioner has. This position will provide for maximum cooling.

*Consoles shown may vary slightly from your air conditioner. The controls on your air conditioner will operate the same as explained in this section.

2. Set the System Control to the desired setting. Suggestions are as follows:

Lo Cool - for sleeping comfort
 Med Cool - for normal cooling
 Hi Cool - for maximum cooling
 Fan Only - for air circulation without cooling.

3. Set the Thermostat Control to number 6. You can adjust the cooling performance by resetting the Thermostat Control to a high number for more cooling or to a lower number for less cooling. You will need to experiment to find the setting which you prefer.

⚠ CAUTION

If you turn your air conditioner off, wait two or three minutes before turning it back on. The amount of time to wait is printed on your console. You may blow the fuse in the fuse box or trip the circuit breaker if you Do Not follow these instructions.

Using special features...

Exhaust Control

Use this feature to draw stale or smoky air from the room or to circulate air in the room.

See the chart to determine what settings to select for the type of air control you desire.

Note: Energy efficiency is decreased when exhausting room air and cooling at the same time.

Air Control

Use this feature to draw stale or smoky air from the room or to circulate fresh air from the outside into the room.

See the chart to determine what settings to select for the type of air control you desire.

Note: Energy efficiency is decreased when exhausting room air or circulating fresh air into the room and cooling at the same time.

Exhaust Control

Room air desired	Exhaust Control setting
Exhaust room air	"Open"
Circulate room air	"Closed"
Cooling only	"Closed"

Air Control

Room air desired	Air Control setting
Exhaust room air	"Exhaust"
Circulate fresh air into the room	"Fresh Air"
Circulate room air	"Off"
Cooling Only	"Off"

Maintaining your air conditioner.

⚠ WARNING

Electrical Shock and Personal Injury Hazard

- Set System Control to the "Unit Off" position. Unplug power supply cord or disconnect power supply at the fuse or circuit breaker box before cleaning and maintaining your air conditioner.
- Carefully handle air conditioner. Metal fins on the front and rear coils have sharp edges.
- Cover motor, electrical control box and compressor electrical terminals to prevent water or other liquids from getting into these areas when cleaning and maintaining air conditioner.
- Do Not drink any water that collects within air conditioner. This water is not sanitary.
- Do Not use cleaning fluids, solvents, abrasive cleaners, or strong detergents. Such use may damage air conditioner parts.
- More than one person is required to lift the air conditioner because of its weight and size.

Failure to follow these instructions may result in personal injury or damage to the air conditioner.

Annual maintenance of your air conditioner is needed to keep your air conditioner operating at top performance.

Your local dealer can recommend a service company to complete the needed checks and maintenance. Or if you are familiar with electrical appliances, you can do the cleaning and maintenance. Maintenance steps are listed below. The expense of an annual maintenance is the customer's responsibility.

The key components to check include:

- Coils and condensate water passages - inspect and clean.
- Fan - inspect.
- Fan motor - inspect and oil.

The compressor is sealed and never needs oiling.

Maintenance Steps for Models

X05002V0	X05002W0
X07502V0	X07002W0
X10002V1	X10002W0:
X12002V0	

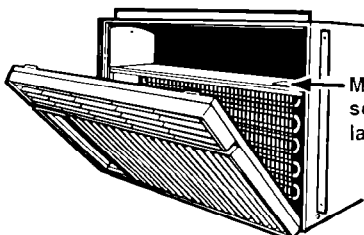

Model and serial number label

1. Set System Control to the "Unit Off" position. Disconnect power supply cord from electrical outlet.
2. Remove air conditioner from window.
3. Press down on the top edge of front panel until it releases from the cabinet. Pull front panel toward you. Lift up and away from bottom spring clips.

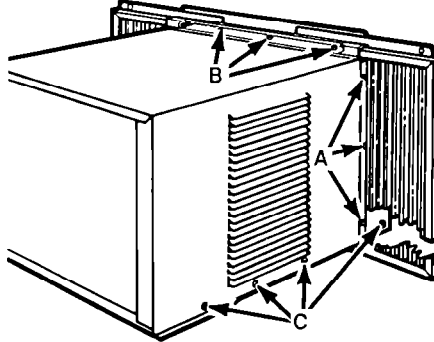

4. Slide curtains out to fullest width. Remove 6 Phillips-head screws that attach curtains to cabinet. (A)
5. Remove slotted-hex head screws from top channel (B) and sides (C) of cabinet.
6. Hold the cabinet on both sides and carefully lift cabinet off of air conditioner.
7. Wrap the motor, electrical control box and compressor terminal box in plastic film to make sure no water or other liquid can get inside. Water or other liquids could damage insulation and cause serious mechanical problems.
8. Carefully clean and hose out the base, coils and condensate pans. The areas listed may need to be cleaned more frequently especially if you notice an odor coming from the air conditioner.
9. Remove plastic film from motor and electrical parts.

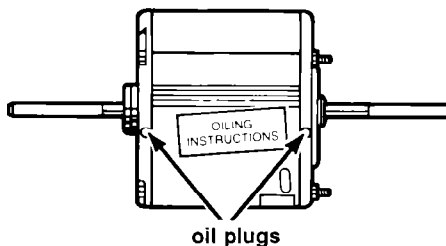

oil plugs

10. Oil the fan motor as instructed on the motor. Remove the oil hole plug at each end of the motor to add oil. An easy-to-use oil capsule is available from local service centers or you can use SAE #20 nondetergent oil. Replace plugs into each end of the motor.

11. Reinstall cabinet over air conditioning unit using all the slotted-hex head screws.
12. Reinstall the slide curtains using the Phillips-head screws.
13. Replace the front panel.

Wait 24 hours before starting the air conditioner again. This will give time for all areas to dry completely.

Maintenance Steps for Model X18004V0:

1. Set System Control to the "Unit Off" position. Disconnect power supply cord from electrical outlet.
2. Press down on the top edge of front panel until it releases from the cabinet. Pull front panel toward you. Lift up and away from bottom spring clips.

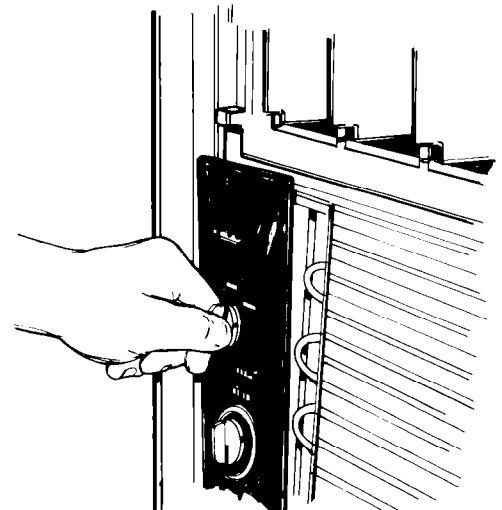

3. Pull control knobs straight off. Remove control panel.
4. Remove the green grounding wire screw located at the bottom left side under the control panel. Save this screw to reattach wire.

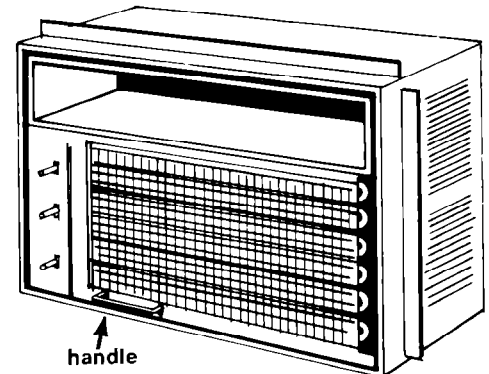

5. Pull out wire handle at bottom and slide air conditioner unit out of cabinet.

Maintaining your air conditioner, continued

6. Wrap the motor, electrical control box and compressor terminal box in plastic film to make sure no water or other liquid can get inside. Water or other liquids could damage insulation and cause serious mechanical problems.
7. Carefully clean and hose out the base, coils and condensate pans. The areas listed may need to be cleaned more frequently especially if you notice an odor coming from the air conditioner.

8. Remove plastic film from motor and electrical parts.

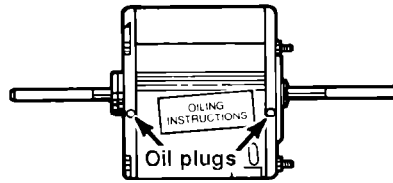

9. Oil the fan motor as instructed on the motor. Remove the oil hole plug at each end of the motor to add oil. An easy-to-use oil capsule is

- available from local service centers or you can use SAE #20 nondetergent oil. Replace plugs into each end of the motor.
10. Reinstall air conditioner unit into cabinet.
 11. Reattach grounding wire. Replace control panel and knobs.
 12. Replace the front panel.

Wait 24 hours before starting the air conditioner again. This will give time for all areas to dry completely.

Before you call for service...

If you are having an operating problem, check the chart to see what the cause might be before you call for assistance.

Operating problem	Check if	What to do
Air conditioner will not run.	▪ Power cord is plugged into a live circuit with proper voltage.	Firmly plug power cord into electrical outlet. Check circuit voltage at fuse/circuit breaker box.
	▪ System control is turned on.	Turn System Control to a "Cool" position.
	▪ Thermostat control is set at a high enough number to cause the air conditioner to run.	Set Thermostat Control to a higher number.
	▪ Fuse has blown or circuit breaker has tripped. Also check to see if a time-delay fuse is being used.	Replace fuse with a time-delay fuse of the correct capacity. Reset circuit breaker.
Air conditioner blows fuses.	▪ Correct type and ampere fuse is used.	Use a time-delay fuse with the correct ampere capacity.
	▪ An extension cord is being used.	Do Not use an extension cord.
	▪ You waited 2 minutes after turning air conditioner off before attempting to restart.	Wait at least 2 minutes before restarting air conditioner.
Air conditioner turns on and off or does not cool room.	▪ Filter is clean.	Follow the filter cleaning instructions in this Guide.
	▪ Evaporator (inside) and condenser coils are clean.	Follow the annual maintenance instructions in this Guide.
	▪ Excessive moisture or heat from cooking or showers is in cooling area.	Use exhaust venting fans to remove moisture or heat from cooling area.
	▪ Fan setting is too low.	Set fan setting to a higher speed.
	▪ Thermostat setting is at high enough number to cause the air conditioner to cool room.	Set Thermostat Control to a higher number.

Normal operating sounds.

You can expect to hear the following sounds when your air conditioner is operating:

- Droplets of water hitting the condenser causing a "pinging" or "clicking" sound. Water from normal operation or rainfall does not harm components, so you should not be concerned.
- Air movement from the fan occurs especially at high fan-speed settings.
- Vibration sounds can be caused by wall construction or mounting for the air conditioner.

Changing air direction.

Locate tabs at the bottom or the top of the grille and move the tab in the direction in which you want the air to

flow (right, left or straight). A tab in the center of the grille area on some models will adjust air flow up or down.

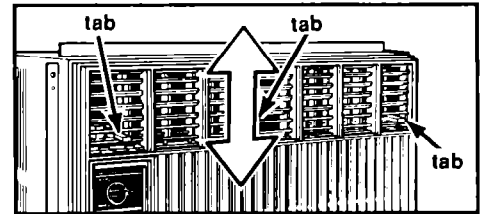
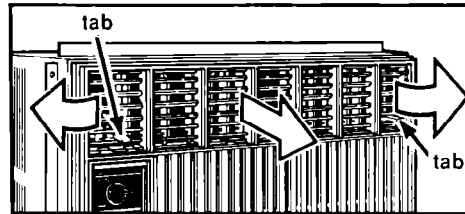
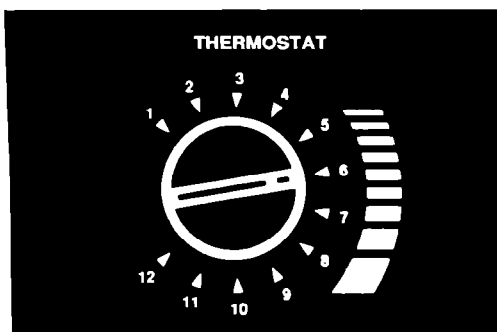
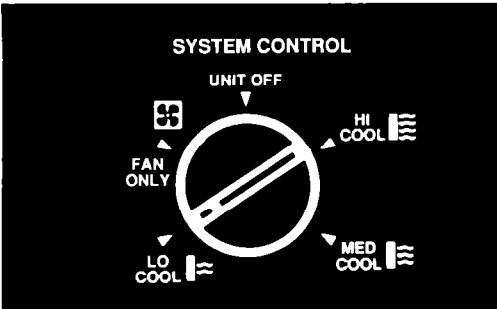
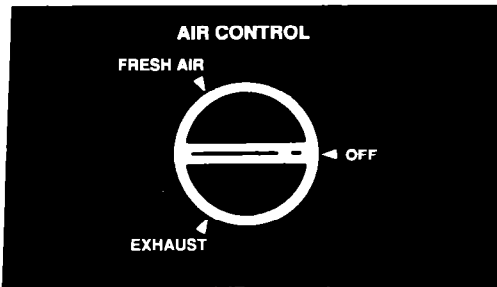

Cleaning your air conditioner.

⚠ WARNING

Electrical Shock and Personal Injury Hazard

- Set System Control to the "Unit Off" position. Unplug power supply cord or disconnect power supply at the fuse or circuit breaker box before cleaning and maintaining your air conditioner.
 - Do Not drink any water that collects within air conditioner. This water is not sanitary.
 - Do Not use cleaning fluids, solvents, abrasive cleaners, or strong detergents. These may damage air conditioner parts.
- Failure to follow these instructions may result in personal injury or damage to the air conditioner.

Cleaning the air conditioner front panel and filter regularly, every two weeks, will help to ensure longer life and lower operating costs. The filter helps to remove dust, lint and other particles from the air.

Disconnect power supply cord before starting cleaning process.

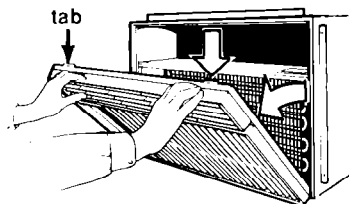

1. Press down on the top edge of front panel until it releases from the cabinet.

2. Pull front panel toward you. Lift up and away from bottom spring clips.

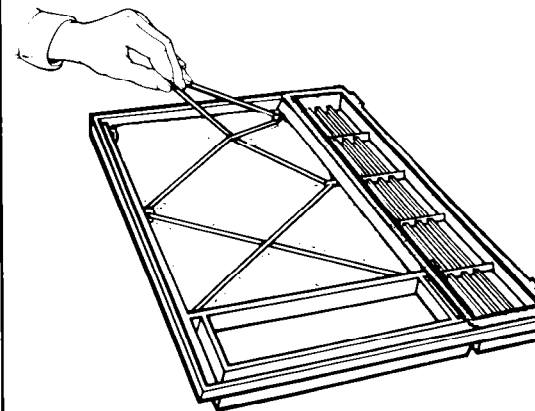

3. Remove elastic band from the back side of the front panel. Remove filter.
4. Use vacuum cleaner to remove dust. If the filter is very dirty, wash filter in warm water using a mild detergent. The filter should air dry before you replace it. Do not use a hair dryer to dry the filter.
5. Use a soft cloth soaked in warm water with mild detergent to clean the front panel. Rinse the front panel and dry. Clean the control area with a soft dry cloth.
6. Place filter in back of front panel. Replace elastic band.
7. Put bottom of front panel into spring clips. Press down on top edge of front panel and push panel toward unit. Snap front panel tabs into place in cabinet.

System Control Setting	
Cooling is wanted	Cooling is Not wanted
Select a "Cool" setting	Select "Fan Only"
Select a "Cool" setting	Select "Fan Only"
Select a "Cool" setting	-----

System Control Setting	
Cooling is wanted	Cooling is Not wanted
Select a "Cool" setting	Select "Fan Only"
Select a "Cool" setting	Select "Fan Only"
Select a "Cool" setting	Select "Fan Only"
Select a "Cool" setting	-----

If you need assistance, service or replacement parts...

Read the warranty. Contact your local dealer for the recommendation of a local service company or to obtain replacement parts.

You will need the model number and serial number when you call for assistance or service. Both numbers are located behind the front panel on a label attached to the evaporator coil cover near the top of the unit.

LIMITED WARRANTY

The logo for Roper Appliances, featuring the word "ROPER" in a bold, sans-serif font, with a thick horizontal bar above and below the letters.

Appliances

This Roper appliance is warranted by Whirlpool Corporation to be free from defect in material and workmanship to the original domestic purchaser. Any parts which we find to be defective will be repaired or replaced at our option subject to the following limitations:

1. Repair or replace during the first thirty (30) days from the date of purchase any finishes (porcelain, enamel or other) and glass parts which we find to be defective.
2. Repair or replace during the first (1st) year from date of purchase any other part except for the finish, which we find to be defective.
3. Repair or replace during the first five (5) years from date of purchase any magnetron (on those units so equipped) which we find to be defective. Labor on any magnetron under warranty is limited to the first (1st) year from date of purchase.
4. During the second (2nd) through the fifth (5th) years from the date of original purchase on any product so equipped, any part of the refrigerating system (compressor, evaporator, condenser, drier or connecting tubing) or any part of the washer gear case assembly found defective in material or workmanship, will be supplied. Labor on the gear case assembly under this warranty is limited to the first (1st) year from the date of original purchase.
5. Replacement parts furnished under the terms of this warranty are warranted only for the unexpired portion of the original warranty period and transportation charges relative to obtaining parts involved are the responsibility of the original consumer purchaser.
6. This warranty applies only to products properly installed, adjusted and operated in accordance with instructions found in the product literature. This warranty does not apply to any product which has been subjected to alteration, misuse, improper installation or delivery damage. Nor does it apply to costs for any service requested for demonstration or to confirm proper operation of appliance, or when used in other than, single-family household use.
7. Any repairs made under the terms of this warranty must be performed by a Roper brand appliance servicer authorized by warrantor.

SHOULD YOU HAVE ANY QUESTIONS CONCERNING THIS WARRANTY, PLEASE CONTACT:

Customer Relations Dept.
ROPER Brand Appliances
2000 M 63 North
Benton Harbor, MI 49022

Call Toll Free 1-(800) 44-ROPER
1-(800) 447-6737
Between 8:00 a.m. - 4:30 p.m.
Monday thru Friday, Eastern Time

If you write or call, please furnish complete model and serial number of appliance and date of purchase.

Under no circumstances shall Whirlpool Corporation be liable under this warranty for any loss of any incidental or consequential damages and all IMPLIED WARRANTIES ARE LIMITED TO THE SAME TIME PERIODS STATED HEREIN ON EXPRESS WARRANTIES FOR ROPER BRAND APPLIANCES.

Some states do not allow the exclusion or limitation of consequential damages or limitations of how long an implied warranty may last, so the above limitations or exclusions may not apply to you. This warranty gives you specific legal rights, and you may have other rights which may vary from state to state.

THIS IS A LIMITED WARRANTY WITHIN THE MEANING OF THAT TERM AS DEFINED IN THE MAGNUSON-MOSS ACT OF 1975.

If you need service for your Roper brand appliance:

- Contact your selling dealer for the authorized servicer in your area.
- OR-
- Phone 1-(800) 44-ROPER [1-(800)447-6737] BETWEEN 8:00 - 4:30 Eastern Time - Monday thru Friday.

The Roper Appliances logo, featuring the word "ROPER" in a bold, sans-serif font, with a thick horizontal bar above and below the letters, and the word "Appliances" in a smaller font below it.