

GoldStar

OWNER'S MANUAL
MANUAL DEL PROPIETARIO

ENGLISH

ESPAÑOL

ROOM AIR CONDITIONER **AIRE ACONDICIONADOR** Models/Modelo GWHD6507R

IMPORTANT

- Please read this owner's manual carefully and thoroughly before installing and operating your room air conditioner.
- Please retain this owner's manual for future reference after reading it thoroughly.

PRECAUTION

- Antes de instalar y poner en marcha su ventilador de casa, haga el favor de leer cuidadosamente esta Instrucción de Usuario.
- Luego de su lectura, guarde este manual para el futuro usuario para las referencias.

TABLE OF CONTENTS

Safety Precautions	3
Before Operation	7
Introduction	8
Symbols Used in this Manual	8
Features	8
Electrical Safety	9
Temporary Use of an Adapter	10
Temporary Use of an Extension Cord	10
Installation	11
Window Requirements	11
Size	11
Clearance	12
Preparation of Chassis	13
Unit Installation	14
Operating Instructions	16
Location and Function of Controls	16
Remote Control Operations	17
Remote Controller	18
Additional Features.....	19
Air Direction	19
Drain Pipe.....	19
Removal from Window.....	19
Maintenance and Service	20
Air Filter	20
Cleaning the Air Conditioner	20
How to Remove the Front Grille	21
Common Problems and Solutions.....	22
Troubleshooting	23



FOR YOUR RECORDS

Write the model and serial numbers here:

Model # _____

Serial # _____

You can find the numbers on a label on the side of the product.

Dealer's Name _____

Date Purchased _____

■ Staple your receipt to this page in the event you need it to prove date of purchase or for warranty issues.



READ THIS MANUAL

Inside you will find many helpful hints on how to use and maintain your air conditioner properly. Just a little preventive care on your part can save you a great deal of time and money over the life of your air conditioner.

You'll find many answers to common problems in the chart of troubleshooting tips. If you review our chart of

Troubleshooting Tips first, you may not need to call for service at all.



PRECAUTION

- Contact an Authorized Service Center for repair or maintenance of this unit. Call 1-800-243-0000 to locate the nearest ASC.
- This air conditioner is not intended for use by young children or invalids without supervision.
- Young children should be supervised to ensure that they do not play with the air conditioner.
- If the power cord requires replacement, have an Authorized Servicer install an exact replacement part.
- Installation work must be performed in accordance with the National Electric Code by qualified and authorized personnel only.



Safety Precautions



To prevent injury to the user or other people and property damage, the following instructions must be followed.

- Incorrect operation due to ignoring instructions will cause harm or damage. The seriousness is classified by the following indications.
- Because of the weight of the product, it is recommended that you have a helper to assist in the installation.

⚠ WARNING This symbol indicates the possibility of death or serious injury.

⚠ CAUTION This symbol indicates the possibility of injury or damage to property only.

- Meanings of symbols used in this manual are as shown below.

	Be sure not to do.
	Be sure to follow the instruction.

⚠ WARNING

• Installation

Always install the expansion panel(s).

- Improper assembly or installation may cause incorrect operation, including injury, fire, and poor performance electric shock hazards.



Do not use the power cord near flammable gas or combustibles such as gasoline, benzene, thinner, etc.

- It may cause explosion or fire.



Do not place the power cord near a heater.

- It may cause fire and electric shock.

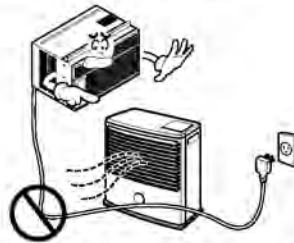

Do not disassemble or modify products.

- It may cause failure and electric shock.



■ Operation

Plug in the power plug properly.

- Otherwise, it will cause electric shock or fire due to heat generation or electric shock.

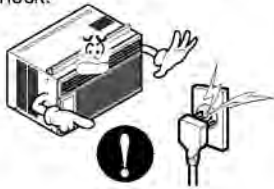

Do not operate or stop the unit by inserting or pulling out the power plug.

- It will cause electric shock or fire due to heat generation.



Do not damage or use an unspecified power cord.

- It will cause electric shock or fire.



Do not modify power cord length.

- It will cause electric shock or fire due to heat generation.

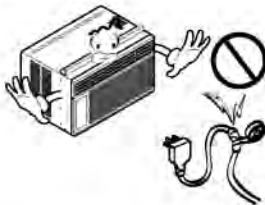

Use the air conditioner on a single outlet circuit. (See page 7.) Do not share the outlet with other appliances.

- It will cause electric shock or fire due to heat generation.

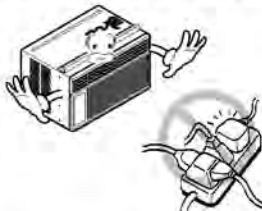

Always plug into a grounded outlet.

- No grounding may cause electric shock (See Installation Manual).

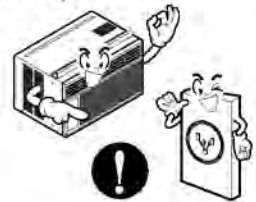

Unplug the unit if strange sounds, odors, or smoke come from it.

- Otherwise it may cause fire and electric shock accident.



Do not use the socket if it is loose or damaged.

- It may cause fire and electric shock.

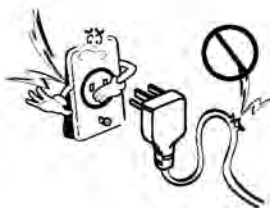

Do not operate with wet hands or in damp environment.

- It will cause electric shock.

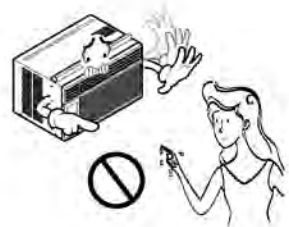

Do not allow water to run into electric parts.

- It will cause failure of machine or electric shock.



Leave the door closed while the air conditioner is running.

- It is not designed to cool the entire house.

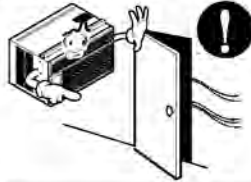

Do not operate the air conditioner if you smell gas.

- It may cause explosion, fire, and burn.



CAUTION

Installation

Never touch the metal parts of the unit when removing the filter.

- They are sharp and may cause injury.

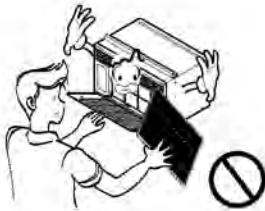

Do not block the inlet or outlet.

- It may cause failure of appliance or accident.



Ensure that the outer case is not damaged by age or wear.

- If the outer case is damaged, it must be repaired or replaced immediately. Leaving it damaged could result in the air conditioner falling out of the window, creating a safety hazard.



Operation

Be cautious not to touch the sharp edges when installing.

- It may cause injury.

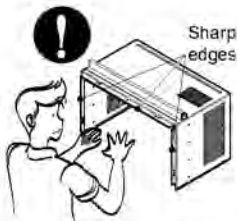

Hold the plug by the head when taking it out.

- It may cause electric shock and damage.



Unplug the air conditioner if it will not be used for a long period.

- Prevent accidental startup and the possibility of injury.



Do not place heavy object on the power cord and take care so that the cord should not be pressed.

- There is danger of fire or electric shock.



If water enters the product, turn off the the power switch of the main body of appliance. Contact service center after taking the power-plug out from the socket.

Do not clean the air conditioner with water.

- Water may enter the unit and degrade the insulation. It may cause an electric shock.

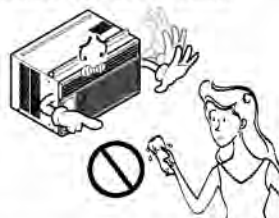

Unplug the air conditioner before cleaning it.

- Since the fan rotates at high speed during operation, it may cause injury.



Do not put a pet or house plant where it will be exposed to direct air flow. (Don't sit in the draft.)

- This could injure the pet or plant.



Do not use this appliance for special purposes such as cooling pets, foods, precision, machinery, or objects of art.

- It is an air conditioner, not a precision refrigeration system.

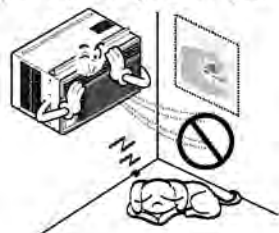

Always insert the filter securely. Clean it every two weeks.

- Operation without filters **will** cause failure.



Use a soft cloth to clean. Do not use wax, thinner, or a strong detergent.

- The appearance of the air conditioner may deteriorate, change color, or develop surface flaws.



Do not drink water drained from air conditioner. Do not direct airflow at room occupants only.

- It contains containments and will make you sick. This could damage your health.



Before Operation

Preparing for Operation

1. Plug in the power cord properly.
2. Use a dedicated circuit. Overloading the line could create a fire hazard.
3. Do not use an extension cord. See page 10 for more details.
4. Do not start/stop operation by plugging/unplugging the power cord.
5. If the power cord is damaged and requires replacement, have an Authorized Servicer install an exact replacement part.

Usage

1. Being exposed to direct airflow for an extended period of time could be hazardous to your health. Do not expose occupants, pets, or plants to direct airflow for extended periods of time.
2. Due to the possibility of oxygen deficiency, ventilate the room when used together with stoves or other heating devices.
3. Do not use this air conditioner for non-specified special purposes (e.g. preserving precision devices, food, pets, plants, and art objects). Such usage could damage the items.
4. The air conditioner is a consumer comfort appliance, not a precision climate control system.

Cleaning and Maintenance

1. Do not touch the metal parts of the unit when removing the filter. Injuries can occur when handling sharp metal edges.
2. Do not use water to clean inside the air conditioner. Exposure to water can destroy the insulation, leading to possible electric shock.
3. When cleaning the unit, first make sure that the power and breaker are turned off. The fan rotates at a very high speed during operation. There is a possibility of injury if the unit's power is accidentally triggered on while cleaning inner parts of the unit.

Service

For repair and maintenance, contact an Authorized Service Center. See the warranty page for details or call (800) 243-0000. Have your model number and serial number available. They should be written on page 2 of this manual.

Introduction

Symbols Used in this Manual



This symbol alerts you to the risk of electric shock.



This symbol alerts you to hazards that could cause harm to the air conditioner.



This symbol indicates special notes.

Features



WARNING: This appliance should be installed in accordance with the National Electric Code.

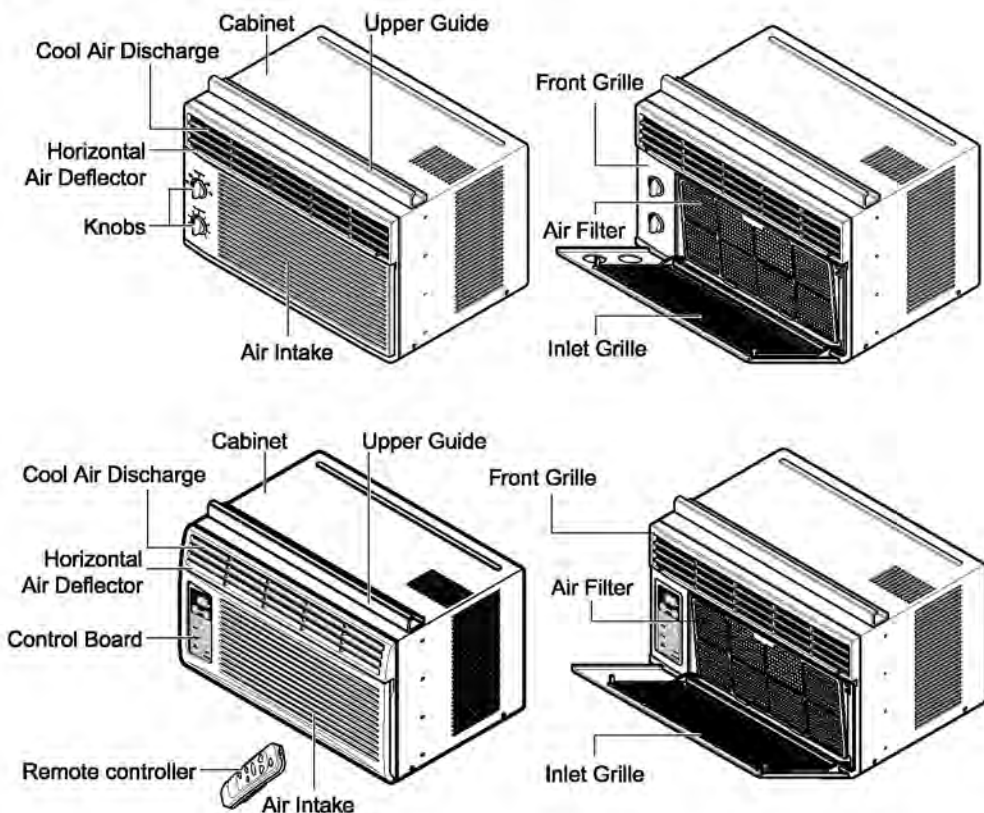

Electrical Safety

Power cord may include a current interrupter device. A test and reset button is provided on the plug case. The device should be tested on a periodic basis by first pressing the TEST button and then the RESET button. If the TEST button does not trip or if the RESET button will not stay engaged, discontinue use of the air conditioner and contact a qualified service technician.

Damaged power supply cord must be replaced with a new power supply cord obtained from the product manufacture and not repaired.

⚠ WARNING: This appliance must be properly grounded.

The power cord of this appliance is equipped with a three-prong grounding plug. To minimize the risk of electric shock, use the plug with a standard three-slot grounding wall power outlet. If the power outlet does not include a grounding slot, have a qualified electrician replace the outlet before you use the room air conditioner.

⚠ WARNING: Changing the outlet without making the appropriate wiring changes will create an unsafe condition that could result in fire or electrical shock. Refer all such work to a licensed and qualified electrician.

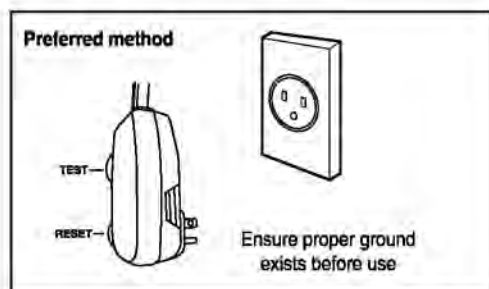

⚠ WARNING: Do not cut or remove the grounding prong from the power plug.

⚠ WARNING: Attaching the adapter ground terminal to the wall receptacle cover screw does not ground the appliance unless the cover screw is metal and not insulated, and the wall receptacle is grounded through the house wiring.

⚠ WARNING: If you have any doubt whether the air conditioner is properly grounded, have the wall receptacle and circuit checked by a qualified electrician.

Temporary Use of an Adapter

We **strongly discourage** the use of an adapter due to potential safety hazards. For temporary connections, use only a UL-listed adapter, available from most local hardware stores. Ensure that the large slot in the adapter is aligned with the large slot in the receptacle for a proper polarity connection.

To disconnect the power cord from the adapter, use one hand on each to avoid damaging the ground terminal. Avoid frequently unplugging the power cord as this can lead to eventual ground terminal damage.

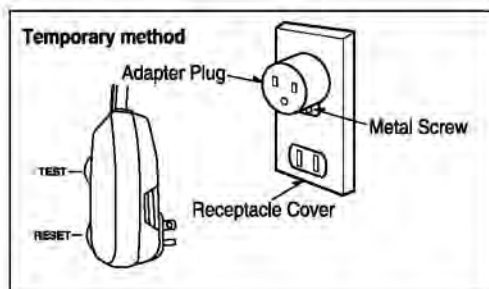





WARNING: Never use the appliance with a broken adapter.

Temporary Use of an Extension Cord

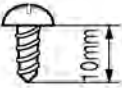
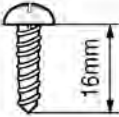
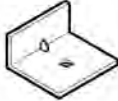
We **strongly discourage** the use of an extension cord due to potential safety hazards. For temporary situations, use only CSA certified and UL listed 3-wire grounded extension cords, rated 15 A, 125 V.

Installation

Type A: 11 EA (Short Screw)		Type B: 5 EA (Wood Screw)		Type C: 3 EA (L Bracket)	
					
Type D: 1 EA (Seal Strip)	Type E: 1 EA (Sash Seal)	Type F: 2 EA (Guide Panel)	Type G: 1 EA (Support Bracket)		
(Adhesive backed)	(Not adhesive backed)				
					

Have the following tools available for installation:

- * Screwdriver (Slotted and Phillips)
- * Knife
- * Pencil
- * Ruler
- * Hammer
- * Level

Window Requirements

Size

This room air conditioner is designed for installation in standard double-hung windows with actual opening widths from 22" to 36". The upper and lower window sash must open sufficiently to allow a clear vertical opening of 13" from the bottom of the upper sash to the window stool.

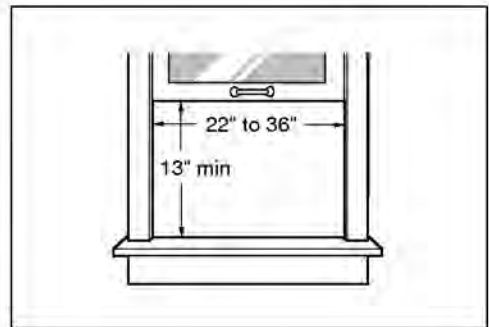

WARNING: This product is a WINDOW AIR CONDITIONER. As such, a standard single-hung or double-hung window is required for proper installation. Non-window installations, including using sleeves, holes in walls, and other installations are not recommended.

Clearance

Proper clearance enhances the cooling efficiency of the unit and prevents heat radiation of the condenser.

1. If a storm window presents interference, fasten a 2" wide wood strip to the inner window sill across the full width of the sill. The wood strip should be thick enough to raise the height of the window sill so that the unit can be installed without interference by the storm window frame.
2. See Figure. B. The top of the wood strip should be approximately $\frac{3}{4}$ " higher than the storm window frame (Storm Window Frame) or wood strip (Outdoors) to help condensation to drain properly to the outside.
3. Install a second wood strip (approximately 6" long by $1\frac{1}{2}$ " wide and same thickness as first strip) in the center of the sill flush against the back off the inner sill. This will raise the L bracket as shown Figure. B.
4. If the distance between Storm Window Frame and Wood Strip Mounted on Top of Inner Sill is more than 1", two of wood strips are not necessary.

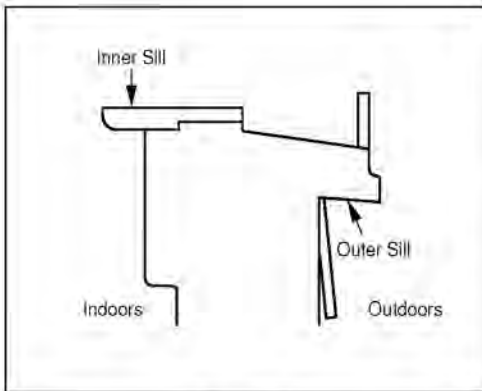

Figure. A

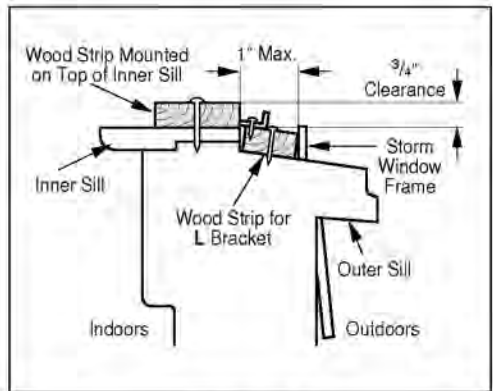
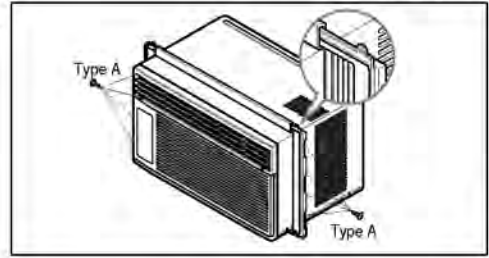

Figure. B

Preparation of Chassis

1. Insert the guide panels into the guides of the air conditioner. Fasten the curtains to the unit with screws (Type A).

Tip! : Use a long screwdriver and installing the screws will be easier.



2. Cut the adhesive-backed seal strip (Type D) to the window width. Remove the backing from the seal strip and attach the seal strip to the underside of the bottom window.

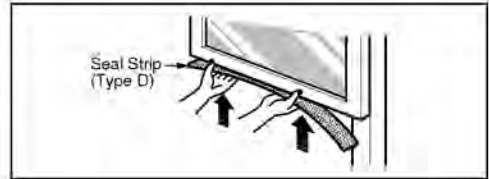

3. Locating unit in window

Open the window and mark center line on the center of the inner sill.

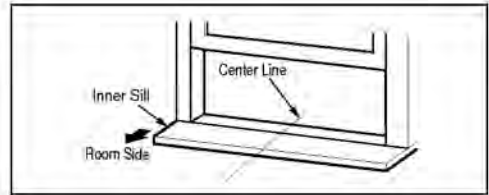

4. Attach L bracket

- 4-1. Install the L brackets behind the inner window sill, with short side of bracket as shown. Use the 2 screws (Type A) provided.
- 4-2. The bracket helps to hold unit securely in place. Be sure to place bracket edge flush against back of inner sill.

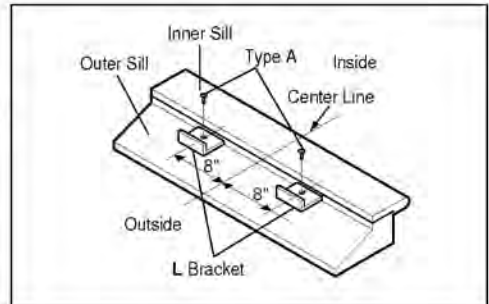

Unit Installation

⚠ Caution: During the following step, hold unit firmly until window sash is lowered to top channel behind side panel frames. Personal injury or property damage may result if unit falls from window.

1. Install the air conditioner in the window

1-1. Carefully lift the air conditioner and slide it into the open window. Make sure the bottom guide of the air conditioner drops into the notches of the L bracket.

Tip! : When the air conditioner drops into the L bracket, the air conditioner will be centered in window opening.

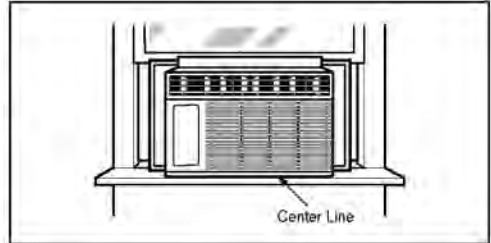

1-2. While steadying the air conditioner, carefully bring the window sash down behind the upper guide of the air conditioner.

When the air conditioner is properly installed, it should tilt slightly down at the back. If it is set correctly in the window, it will hang lower in the back automatically. If it does not, there is a problem with the installation.

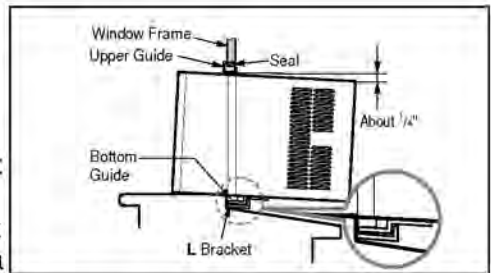

2. Secure the guide panels

Extend the guide panels (Type F) to fill the window opening using 4 screws (Type B) to secure them.

3. Install the sash seal and sash lock

3-1. Cut the sash seal (Type E) to the window width. Stuff the sash seal between the glass and the window to prevent air and insects from getting into the room.

3-2. Fasten the L bracket using a screw (Type A).

3-3. Remove the screws that secure the cabinet and base pan in the right side.

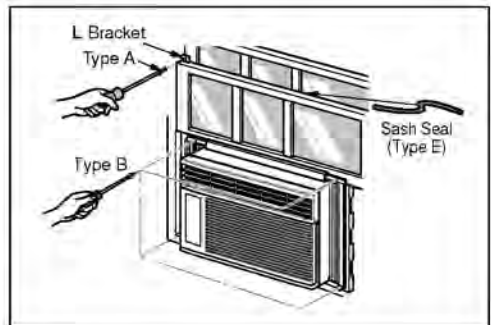

- 3-4. Fasten the support bracket (Type G) using a screw removed from the air conditioner cabinet. Attach the support bracket (Type G) to the inner window sill with a screw (Type B).

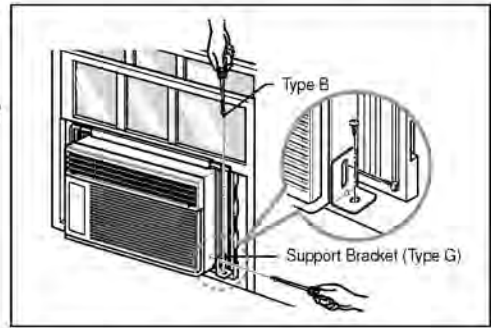

4. **Window installation of room air conditioner is now completed.**
See **ELECTRICAL DATA** for attaching power cord to electrical outlet.

Operating Instructions

Location and Function of Controls

CAUTION: If you turn off the air conditioner or switch from cooling to the fan, wait at least 3 minutes before setting to cooling again.

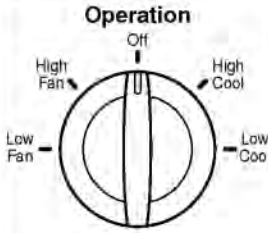
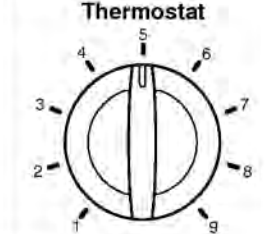
<p style="text-align: center;">Operation</p> 	<p>Off - Turns air conditioner off.</p> <p>High Fan - High speed fan operation without cooling.</p> <p>Low Fan - Low speed fan operation without cooling.</p> <p>High Cool - Cooling with high speed fan operation.</p> <p>Low Cool - Cooling with low speed fan operation.</p>
<p style="text-align: center;">Thermostat</p> 	<p>This automatically controls the temperature of the indoor air.</p> <p>Turn the knob so that arrow points to the larger marks for greater cooling. Point the arrow to the smaller marks for more moderate cooling.</p> <p>(i.e. the higher the number, the greater the cooling)</p>

FOR NORMAL COOLING

1. Turn the operation switch to the **High Cool** or the **Low Cool** setting.
2. Set the thermostat control to the desired temperature mark (the mid-point is a good starting position). If the room temperature is not satisfactory after a reasonable time, adjust the control to a cooler or warmer setting, as appropriate.

FOR MAXIMUM COOLING

1. Turn the operation switch to the **High Cool** setting.
2. Set the thermostat control to the largest temperature mark.

FOR QUIETER OPERATION

1. Turn the operation switch to the **Low Cool** setting.
2. Set the thermostat control as needed.

Remote Control Operations

The controls look like this:

Controls

Temperature Setting

- This button can automatically control the temperature of the room. The temperature can be set within a range of 60 F to 86 F by 1 F.
- Select the lower number for lower temperature of the room.

Energy Saver

- The fan stops when the compressor stops cooling.
- Approximately every 3 minutes the fan will turn on and check the room air to determine if cooling is needed.

Fan/Cool/Dry

- Everytime you push this button, it will toggle between COOL, FAN, and DRY.

On/Off Timer

- Stopping Operation
- Each press of the button cycles through the options in this order: 1 Hour • 2 Hours • 3 Hours • 4 Hours • 5 Hours • 6 Hours • 7 Hours • 8 Hours • 9 Hours • 10 Hours • 11 Hours • 12 Hours • CANCEL.
- The set temperature will be raised 2 F after 30 minutes and again after another 30 minutes.

- Stopping Operation

- Each press of the button cycles through the options in this order: 1 Hour • 2 Hours • 3 Hours • 4 Hours • 5 Hours • 6 Hours • 7 Hours • 8 Hours • 9 Hours • 10 Hours • 11 Hours • 12 Hours • CANCEL.

Fan Speed

- Pressing the Fan Speed button toggles between Low and High speeds.

Power

- To turn the unit ON, push the button. To turn the unit OFF, push the button again.
- This button takes priority over any other buttons.
- When the unit is first powered up, it defaults to settings of High Cool at 72 F.

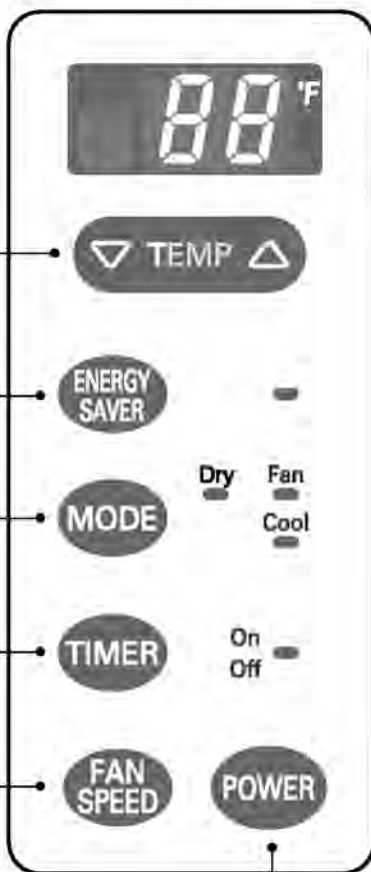

Remote Controller

CAUTION: The Remote Controller will not function properly if strong light strikes the sensor window of the air conditioner or if there are obstacles between the Remote Controller and the air conditioner.

Power

- To turn the Set ON, push the button. To turn the Set OFF, push the button again.
- This button takes priority over any other buttons.
- When you first turn it on, the Set is on the High cool mode and the temp. at 72°F

Temperature Setting

- This button controls the room temperature setting in a range between 60°F and 86°F in 1° increments.

Fan Speed

- Pressing the Fan Speed button toggles between **Low** and **High** speeds.

On/Off Timer

- Stopping Operation

Each press of the button cycles through the options in this order:
1 Hour → 2 Hours → 3 Hours → 4 Hours → 5 Hours → 6 Hours → 7 Hours
→ 8 Hours → 9 Hours → 10 Hours → 11 Hours → 12 Hours → CANCEL.
The set temperature will be raised by 2°F after 30 minutes and again after another 30 minutes.

- Starting Operation

Each press of the button cycles through the options in this order:
1 Hour → 2 Hours → 3 Hours → 4 Hours → 5 Hours → 6 Hours →
7 Hours → 8 Hours → 9 Hours → 10 Hours → 11 Hours → 12 Hours
→ CANCEL.

Energy Saver

The fan stops when the compressor stops cooling.

- Approximately every 3 minutes the fan will turn on and check the room air to determine if cooling is needed.

Cool/Fan/Dry

- Everytime you push this button, it will toggle between COOL, FAN, and DRY.

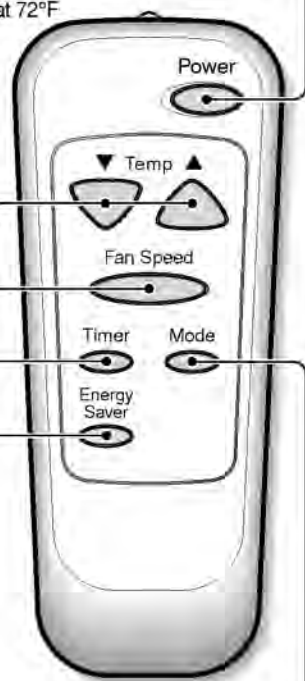

How to Insert Batteries

1. Remove the cover from the back of the remote controller
2. Insert two batteries.
 - Be sure of the polarity when installing the batteries.
 - Be sure that both batteries are new.
3. Re-attach the cover.



- Do not use rechargeable batteries. Such batteries differ from standard dry cells in shape, dimensions, and performance.
- Remove the batteries from the remote controller if the air conditioner is not going to be used for an extended length of time.

Additional Features

Air Direction

Adjusting the air direction using the horizontal air deflector control.

Using the control tabs, the air flow can be directed to the left, right, straight ahead, or any combination of these directions.

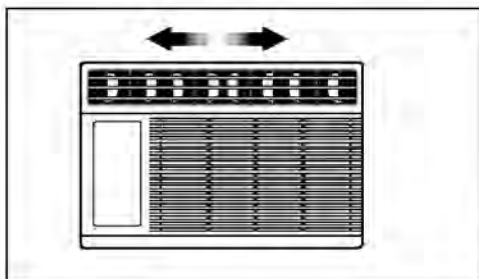

Drain Pipe

In humid weather, excess water may cause the Base Pan to overflow. To drain the water, remove the Drain Cap and secure the Drain Pipe to the rear hole of the Base Pan.

Press the drain pipe into the hole by pushing down and away from the fins to avoid injury.

This air conditioner is equipped with a slinger fan. (See drawing, below.)

The fan has an outer ring that runs in the water that collects in the base pan if it gets deep. That condensate is then picked up by the fan and expelled through the condenser, making the air conditioner more efficient.

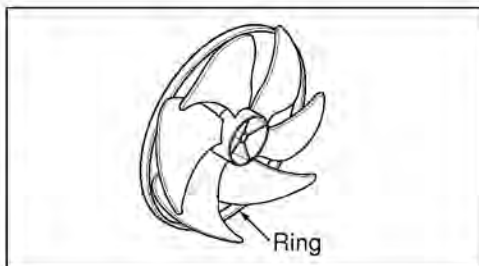
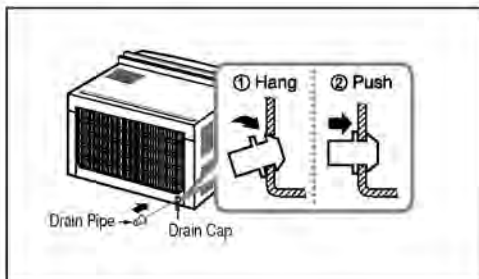

CAUTION: Be careful when inserting the drain pipe. Push away from the sharp fin area to avoid slipping injuring yourself.

Removal From Window

Turn the air conditioner off, disconnect the power cord, remove the L bracket, the screws and Support Bracket installed through the top and bottom of the guide panels, and save for reinstallation later. Close the guide panels. Keeping a firm grip on the air conditioner, raise the sash, and carefully tilt the air conditioner backward, draining any condensate. Lift the air conditioner from the window and remove the sash seal from between the windows.

Be sure to drain ALL condensate from the air conditioner. If you don't, it could run out while you carry the unit, making a mess and creating a slipping hazard. This simple step will save you much cleaning and make a safer work environment.

Maintenance and Service

Air Filter

Check the air filter at least twice a month to see if cleaning is necessary. Trapped particles in the filter can build up and block the airflow, reducing cooling capacity and causing an accumulation of frost on the evaporator. To clean the air filter:

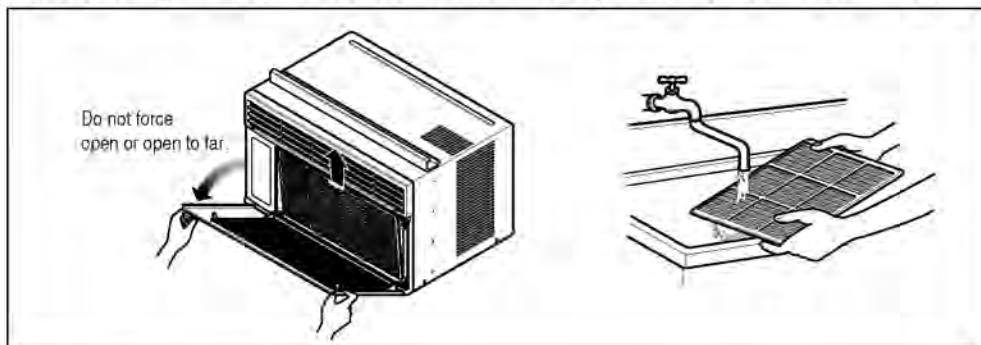

1. Lift the inlet grille.
2. Remove the air filter from the front grille by pulling the air filter up slightly.
3. Wash the filter using lukewarm water below 40 °C (104 °F).
4. Gently shake the excess water from the filter and replace.

Cleaning The Air Conditioner

The front grille and Inlet grille may be wiped with a cloth dampened in a mild detergent solution.

The cabinet may be washed with mild soap or detergent and lukewarm water, then polished with Liquid Wax for Appliances.

To ensure continued peak efficiency, the condenser coils (outside of unit) should be checked periodically and cleaned if clogged with soot or dirt from the atmosphere.

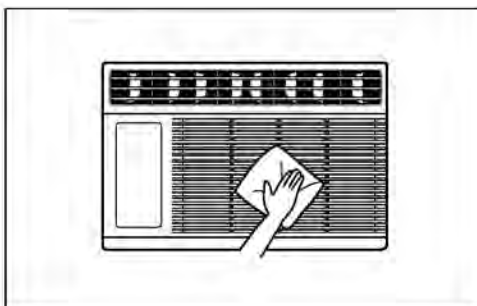

How to Remove the Front Grille

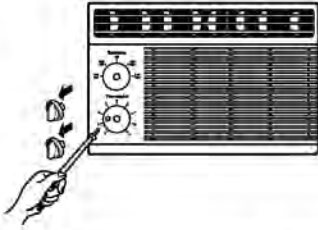

1. Remove the thermostat knob and the operation knob by pulling.
2. Remove the screw securing the Front Grille.

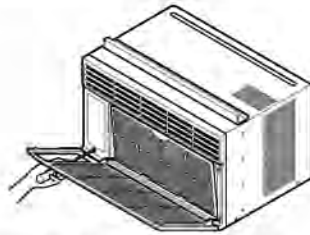

1. Pull the inlet grille forward
2. Remove the screw securing the Front Grille.

3. Push the grille up from the bottom and pull the top of the grille away from the case as the top tabs lift out of their slots.

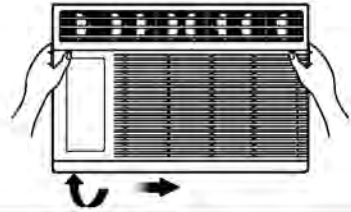

Common Problems and Solutions

Before Calling for Service

If you have problems with your air conditioner, read the following information and try to solve the problem. If you cannot find a solution, turn off the air conditioner and contact your dealer.

Air conditioner does not operate

1. Ensure that the air conditioner is plugged into a proper outlet.
2. Check the fuse or circuit breaker.
3. Check whether the voltage is unusually high or low.

Air does not feel cold enough on the cooling setting

1. Ensure that the temperature settings are correct.
2. Check to see if the air filter is clogged with dust. If so, clean the filter.
3. Ensure that the air flow from the outside is not obstructed and that there is a clearance of over 20" between the back of the air conditioner and the wall or fence behind it.
4. Close all doors and windows and check for any source of heat in the room.



Before calling for service, please review the following list of common problems and solutions.

The air conditioner is operating normally when:

- You hear a pinging noise. This is caused by water being picked up by the fan on rainy days or in highly humid conditions. This feature is designed to help remove moisture in the air and improve cooling efficiency.
See the section on Slinger Fan, page 19.
- You hear the thermostat click. This is caused by the compressor cycle starting and stopping.
- You see water dripping from the rear of the unit. Water may be collected in the base pan in highly humid conditions or on rainy days. This water overflows and drips from the rear of the unit.
- You hear the fan running while the compressor is silent. This is a normal operational feature.

Troubleshooting

The air conditioner may be operating abnormally when:

Problem	Possible Causes	What To Do
Air conditioner does not start	<ul style="list-style-type: none"> ■ The air conditioner is unplugged. 	<ul style="list-style-type: none"> • Make sure the air conditioner plug is pushed completely into the outlet.
	<ul style="list-style-type: none"> ■ The fuse is blown/circuit breaker is tripped. 	<ul style="list-style-type: none"> • Check the house fuse/circuit breaker box and replace the fuse or reset the breaker.
	<ul style="list-style-type: none"> ■ Power failure. 	<ul style="list-style-type: none"> • If power failure occurs, turn the mode control to Off. When power is restored, wait 3 minutes to restart the air conditioner to prevent tripping of the compressor overload.
	<ul style="list-style-type: none"> ■ The current interrupter device is tripped. 	<ul style="list-style-type: none"> • Press the RESET button located on the power cord plug. If the RESET button will not stay engaged, discontinue use of the air conditioner and contact a qualified service technician.
Air conditioner does not cool as it should	<ul style="list-style-type: none"> ■ Airflow is restricted. 	<ul style="list-style-type: none"> • Make sure there are no curtains, blinds, or furniture blocking the front of the air conditioner.
	<ul style="list-style-type: none"> ■ The thermostat may not be set high enough. 	<ul style="list-style-type: none"> • Turn the knob to a higher number. The highest setting provides maximum cooling.
	<ul style="list-style-type: none"> ■ The air filter is dirty. 	<ul style="list-style-type: none"> • Clean the filter at least every 2 weeks. See the care and Maintenance section.
	<ul style="list-style-type: none"> ■ The room may have been hot. 	<ul style="list-style-type: none"> • When the air conditioner is first turned on, you need to allow time for the room to cool down.
	<ul style="list-style-type: none"> ■ Cold air is escaping. 	<ul style="list-style-type: none"> • Check for open furnace floor registers and cold air returns.
	<ul style="list-style-type: none"> ■ Cooling coils have iced up. 	<ul style="list-style-type: none"> • See Air Conditioner Freezing Up below.
Air conditioner freezing up	<ul style="list-style-type: none"> ■ Ice blocks the air flow and stops the air conditioner from cooling the room. 	<ul style="list-style-type: none"> • Set the mode control at High Fan or High Cool with thermostat at 1 or 2.

* You can refer to the Energy Star program in detail at www.energystar.gov.

