

This Owner's Manual is provided and hosted by [Appliance Factory Parts](#).



LG A2NC123GHA0 Owner's Manual

[Shop genuine replacement parts for LG A2NC123GHA0](#)

Exploded View

Exploded View

Indoor Unit

DMC24DB-1, DMH24DB-1

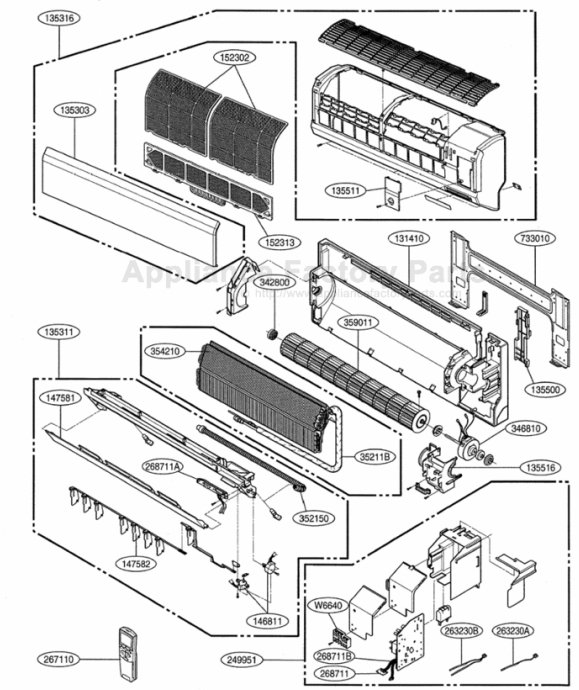

[Find Your LG Air Conditioner Parts - Select From 2330 Models](#)

----- Manual continues below part list -----

Available Replacement Parts for LG A2NC123GHA0

4280A20004M	Bearing
AKB74375404	Ac Remote Control Akb74375404
EBG61325804	Ntc Thermistor Assembly
6871A20782A	Main Pcb Assembly
5901A20017H	Cross Flow Fan Assembly
EBG61107008	Ntc Thermistor Assembly
4681A20042G	Motor Assembly,dc,stepping
6871A20682A	PCB ASSY DISPLAY
5230A20064K	FILTER,AIR
AEM36740103	Drain Hose Assembly

HEAT CONTROLLER, INC.

Wall Mounted Mini-Split System DMC24DB-1, DMH24DB-1 DMC36TB-1, DMH36TB-1 Dual-Zone, Tri-Zone Air Conditioning/Heat Pump



Owner's Manual

Important Information

- Please read carefully and thoroughly this manual before operating this unit.
- Contact a qualified service technician for installation, repair and maintenance of this unit.
- The appliance is not intended for use by young children or those who require supervision.
- Young children should be supervised to ensure that they do not play with the appliance.

TABLE OF CONTENTS

Safety Precautions	3
Prior to Operation	8
Operating Instructions	9
Remote Controller	9
Remote Control Operation	11
Additional features	18
Maintenance and Service	22
Operation Tips	23
Troubleshooting	24



FOR YOUR RECORDS

Write the model and serial numbers here:

Model # _____

Serial # _____

You can find them on a label on the side of each unit.

Dealer's Name _____

Date Purchased _____

- Staple your receipt to this page in the event you need it to prove date of purchase or for warranty issues.



READ THIS MANUAL

Inside you will find many helpful hints on how to use and maintain your air conditioner properly. Just a little preventive care on your part can save you a great deal of time and money over the life of your air conditioner.

You'll find many answers to common problems in the chart of troubleshooting tips. If you review our chart of

Troubleshooting Tips first, you may not need to call for service at all.



PRECAUTION

- Contact the authorized service technician for repair or maintenance of this unit.
- Contact the installer for installation of this unit.
- The air conditioner is not intended for use by young children or invalids without supervision.
- Young children should be supervised to ensure that they do not play with the air conditioner.
- When the power cord is to be replaced, replacement work shall be performed by authorized personnel only using only genuine replacement parts.
- Installation work must be performed in accordance with the National Electric Code by qualified and authorized personnel only.

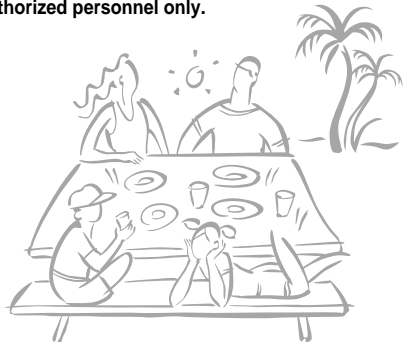

Safety Precautions



To prevent the injury of the user or other people and property damage, the following instructions must be followed.

- Incorrect operation due to ignoring instruction will cause harm or damage. The seriousness is classified by the following indications.

▲ WARNING This symbol indicates the possibility of death or serious injury.

▲ CAUTION This symbol indicates the possibility of injury or damage to properties only.

- The meanings of the symbols used in this manual are as shown below.

	Be sure not to do.
	Be sure to follow the instruction.

▲ WARNING

■ Installation

For electrical work, contact the dealer, seller, a qualified electrician, or an Authorized Service Center.

- There is risk of fire or electric shock.



Install the panel and the cover of control box securely.

- There is risk of fire or electric shock.

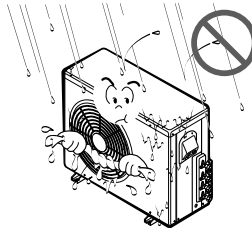

Do not install, remove, or re-install the unit by yourself (customer).

- There is risk of fire, electric shock, explosion or injury.

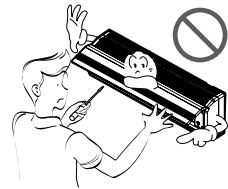

Be cautious when unpacking and installing the product.

- Shape edges could cause injury. Be especially careful of the sharp edges.

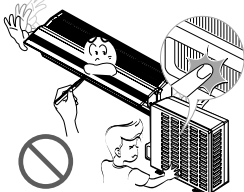

For installation, always contact the dealer or an Authorized Service Center.

- There is risk of fire, electric shock, explosion, or injury.

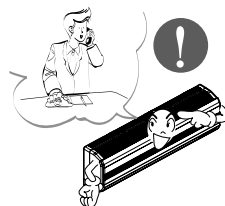

Do not install the product on a defective installation stand.

- It may cause injury, accident, or damage to the product.

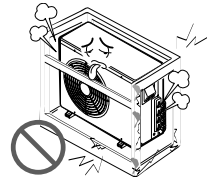

Be sure the installation area does not deteriorate with age.

- If the base collapses, the air conditioner could fall with it, causing property damage, product failure, and personal injury.

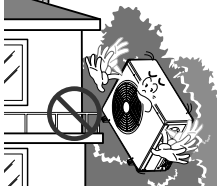

Install the indoor unit on the wall where the height from the floors more than 8ft(2.4m)

- There are sharp moving parts that could cause personal injury.

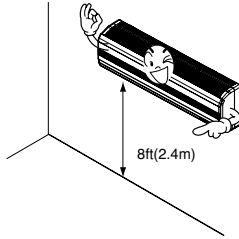

Do not handle the pipe by yourself(Customer)

- High-Pressure refrigerant may cause personal injury.

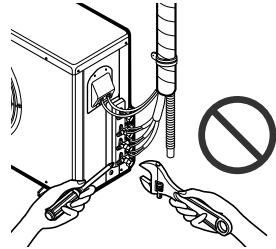

■ Operation

Do not allow water to run into electric part.

- There is risk of fire, failure of the product, and/or electric shock.

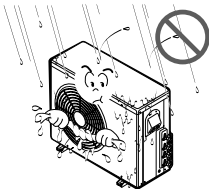

Do not let the air conditioner run for a long time when the humidity is very high and a door or a window is left open.

- Moisture may condense and wet or damage furnishings.

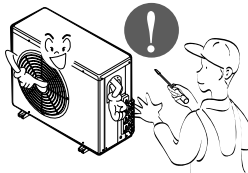

Do not store of use flammable gas or combustibles near the air conditioner.

- There is risk of fire or product failure.

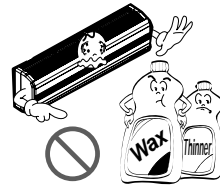

Do not use the product in a tightly closed space for a long time.

- Oxygen deficiency could occur.
- Some ventilation by opening window is necessary for the fresh air

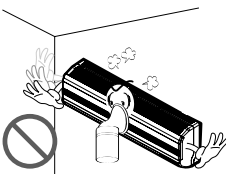

When flammable gas leaks, turn off the gas and open a window for ventilation before turning the product on. Do not use the telephone or turn switches on or off.

- There is risk of explosion or fire.

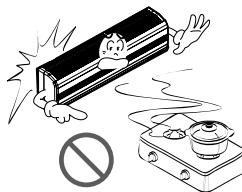

Turn off breaker to the unit if strange sounds odors or smoke comes from it.

- There is risk of fire, Product failure, and/or electric shock.



Stop operation and close any window in storm or hurricane before the hurricane arrives.

- There is risk of property damage, failure of product, or electric shock.

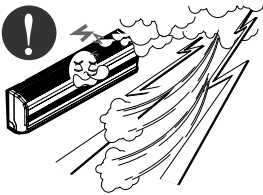

Do not open the inlet grill of the product during operation. (Do not touch the electrostatic filter, if the unit is so equipped.)

- There is risk of physical injury, electric shock, or product.

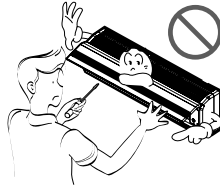

When the product is soaked (flooded or submerged), contact an Authorized Service Center.

- There is risk of electrical shock.

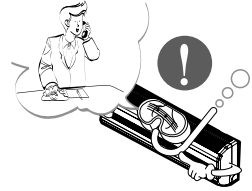

Ventilate the product from time to time when operating it together with a stove, etc.

- There is risk of fire or electrical shock.

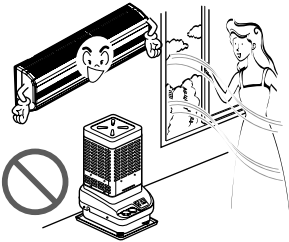

Turn off breaker to the appliance before performing cleaning or maintenance.

- There is risk of electric shock.

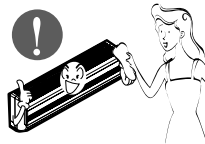

When the product is not be used for a long time disconnect the power supply by turning off the breaker.

- There is risk of product damage or failure, or unintended operation.

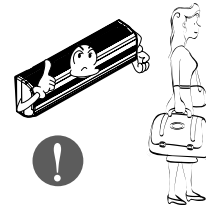

Take care to ensure that nobody could step on or fall onto the outdoor unit.

- There could result in personal injury and product damage.



Do not insert hands or other objects through the air inlet or outlet while the air conditioner is on.

- There are sharp and moving parts that could cause personal injury.

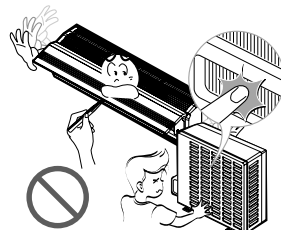

⚠ CAUTION

■ Installation

Always check for gas(refrigerant) leakage after installation or repair of product.

- Low refrigerant levels may cause product failure.

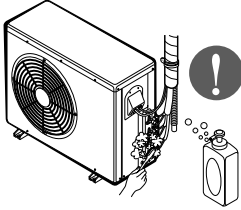

Install the drain hose to ensure that water is drained away properly.

- A bad connection may cause water leakage.

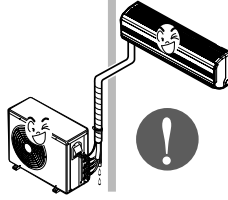

Keep level even when installing the product.

- To avoid vibration or water leakage.

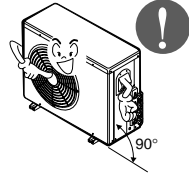

Do not install the product where the noise or hot air from the outdoor unit could offend neighbors.

- It may cause a problem for your neighbors.



Use two or more people to lift and transport the air conditioner.

- Avoid personal injury.

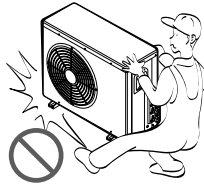

Do not install the product where it will be exposed to sea wind (salt spray) directly.

- It may cause corrosion in the product. Corrosion, particularly on the condenser and evaporator fins, could cause product malfunction or inefficient operation.

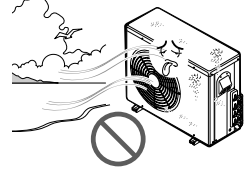

■ Operation

Do not direct airflow at room occupants.

- This could damage your health.



Do not use the product for special purposes, such as preserving foods, works of art, etc. It is a consumer air conditioner, not a precision refrigeration system.

- There is risk of damage or loss of property.

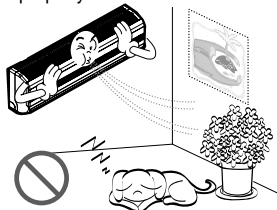

Do not block the inlet or outlet of air flow.

- It may cause product failure.

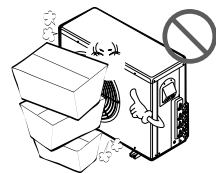

Use a soft cloth to clean. Do not use harsh detergents, solvents, etc.

- There is risk of fire, electric shock or damage to the plastic parts of the product.

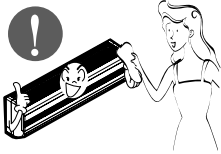

Do not touch the metal parts of the product when removing the air filter. They are very sharp!

- There is risk of personal injury.



Do not step on or put anything on the product. (outdoor unit)

- There is risk of personal injury and failure of product.

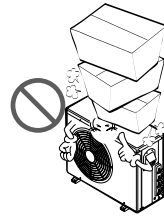

Always insert the filter securely. Clean the filter every two weeks or more often if necessary.

- A dirty filter reduces the efficiency of the air conditioner and could cause product malfunction or damage.



Do not drink the water drained from the unit.

- It is not sanitary and could cause serious health issues.

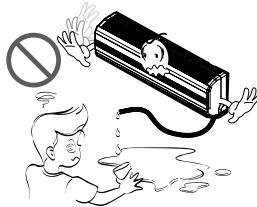

Use a firm stool or ladder when cleaning or maintaining the air conditioner.

- Be careful and avoid personal injury.

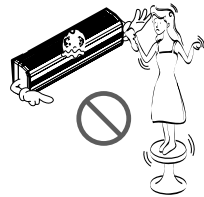

■ Disuse

Replace all the batteries in the remote.

- There is risk of fire or explosion.

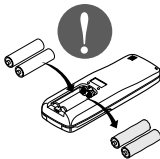

Do not recharge or disassemble the batteries. Do not dispose of batteries in a fire.

- They may burn or explode.



If the liquid from the batteries gets onto your skin or clothes, wash it well with clean water. Do not use the remote if the batteries have leaked.

- The chemicals in batteries could cause burns or other health hazards.



Prior to operation

Preparing for operation

1. Contact an installation specialist for installation.
2. Connect the power cable between indoor unit and outdoor unit properly.
3. Use a dedicated circuit.

Usage

1. Being exposed to direct airflow for an extended period of time could be hazardous to your health. Do not expose occupants, pets, or plants to direct airflow for extended periods of time.
2. Do not use this air conditioner for non-specified special purposes (e.g. preserving precision devices, food, pets, plants, and art objects). Such usage could damage the items.

Cleaning and maintenance

1. Do not touch the metal parts of the unit when removing the filter. Injuries can occur when handling sharp metal edges.
2. Do not use water to clean inside the air conditioner. Exposure to water can destroy the insulation, leading to possible electric shock.
3. When cleaning the unit, first make sure that the power and breaker are turned off. There is a possibility of injury if the unit's power is accidentally triggered on while cleaning inner parts of the unit.

Service

For repair and maintenance, contact your authorized service dealer.

Symbols Used in this Manual



This symbol alerts you to the risk of electric shock.



This symbol alerts you to hazards that could cause harm to the air conditioner.

NOTICE

This symbol indicates special notes.

Operating Instructions

Remote Controller

1. Remove the battery cover by pulling it according to the arrow direction.
2. Insert new batteries making sure that the (+) and (-) of battery are installed correctly.
3. Reattach the cover by sliding it back into position.

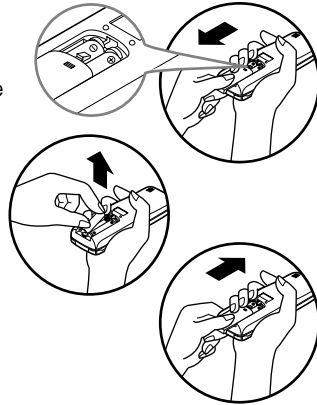

NOTICE Use 2 AAA(1.5volt) batteries. Do not use rechargeable batteries.

Storage and Tips For Using the Remote Controller

- The remote control may be stored mounted on a wall.

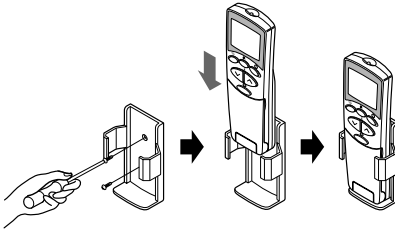

- To operate the room air conditioner, aim the remote control at the signal receptor.
- The remote control will operate the air conditioner at a distance of up to 7m(23ft).

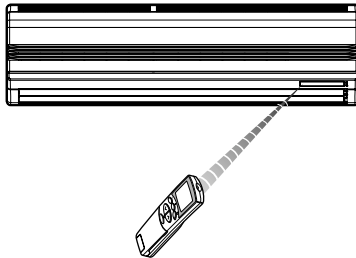

Signal Receptor

Receives the signals from the remote controller.(Signal receiving sound: two short beeps or one long beep.)

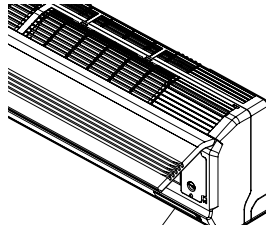

Operation indicating lamps

Operation Indication Lamps

- ⓘ **On/Off** : Lights up during the system operation.
- ☆ **Sleep Mode** : Lights up during Sleep Mode Auto operation.
- 🕒 **Timer** : Lights up during Timer operation.
- ❄️ **Defrost Mode**: Lights up during Defrost Mode or Hot Start operation (Heat pump model only)
- OUT DOOR **Outdoor unit operation** : Lights up during outdoor unit operation.(Cooling model only)



- Desire temperature indicator** For cooling,dehumidification,heating modes it display Destired temperature
 - Cooling : 18°C~30°C(64°F~86°F)
 - Dehumidification : 18°C~30°C(64°F~86°F)
 - Heating : 16~30°C(60°F~86°F)
 - AI : Auto Operation
 - Po : Jet Cool
 - Lo : Test Mode

Remote Control Operation

Controls

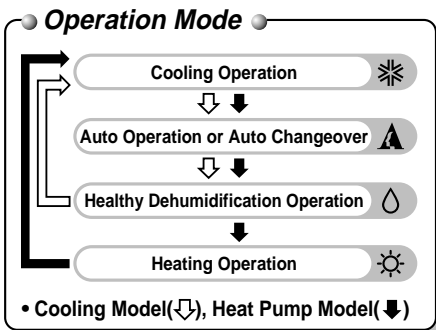
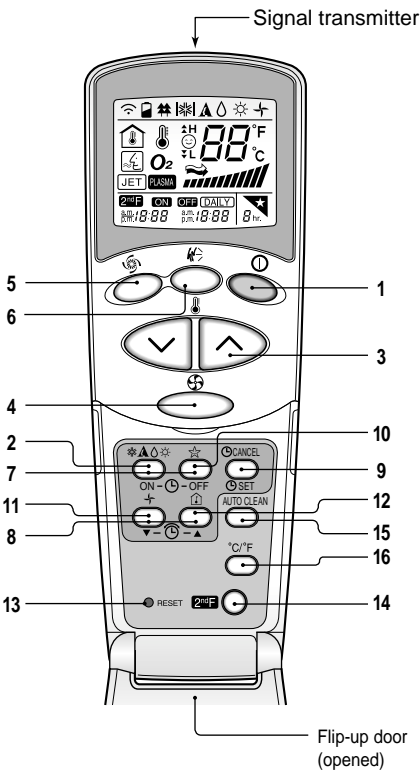

1. START/STOP BUTTON

Operation starts when this button is pressed and stops when the button is pressed again.



2. OPERATION MODE SELECTION BUTTON

Used to select the operation mode.

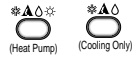

3. ROOM TEMPERATURE SETTING BUTTONS

Used to select the room temperature.



4. INDOOR FAN SPEED SELECTOR

Used to select fan speed in four steps low, medium, high and CHAOS.



5. JET COOL

Used to start or stop the speed cooling/heating. (speed cooling/heating operates super high fan speed.)



6. CHAOS SWING BUTTON

Used to stop or start louver movement and set the desired up/down airflow direction.



7. ON/OFF TIMER BUTTONS

Used to set the time of starting and stopping operation. (See page 18)

8. TIME SETTING BUTTONS

Used to adjust the time. (See page 18)

9. TIMER SET/CANCEL BUTTON

Used to set the timer when the desired time is obtained and to cancel the Timer operation. (See page 18)

10. SLEEP MODE AUTO BUTTON

Used to set Sleep Mode Auto operation. (See page 18)

11. AIR CIRCULATION BUTTON

Used to circulate the room air without cooling or heating. (See page 19)

12. ROOM TEMPERATURE CHECKING BUTTON

Used to check the room temperature.

13. RESET BUTTON

Used prior to resetting time.

14. 2nd F Button

Used prior to using modes printed in blue at the bottom of buttons. (See page 17)

15. AUTO CLEAN

Used to set Auto Clean mode.

16. °C TO °F SWITCHING BUTTON

Used to switch temperature reading from Centigrade to Fahrenheit.



Cooling Operation

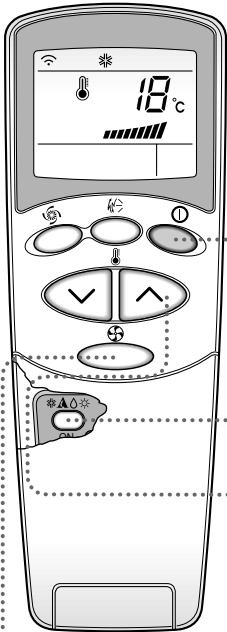

- 1** Press the Start/Stop button.
The unit will respond with beep sound.



- 2** Open the door on the Remote Controller. To select **Cooling Operation**, press the Operation Mode Selection button. Each time the button is pressed, the operation mode is shifted in the direction of the arrow.

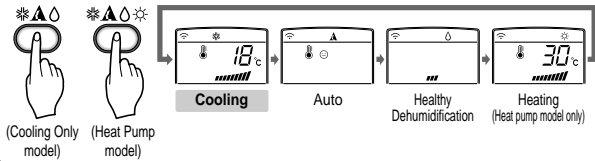

- 3** Set the temperature lower than the room temperature.
The temperature can be set within a range of 18°C~30°C(64°F~86°F) in 1°C(2°F) .

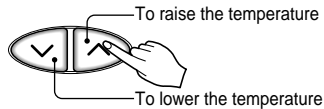

- 4** You can select the fan speed in four steps—low, medium, high, or CHAOS. Each time the button is pressed, the fan speed mode is shifted.

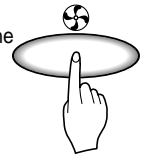

Natural wind by the CHAOS logic

- For more fresh feeling, press the Indoor Fan Speed Selector and set CHAOS mode. In this mode, the wind blows like natural breeze by automatically changing fan speed according to the CHAOS logic.



Auto Operation

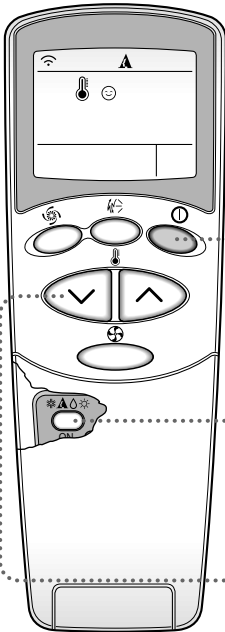

- 1 Press the Start/Stop button.
The unit will respond with beep sound.

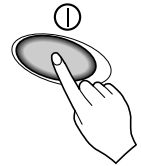

- 2 Open the door on the Remote Controller. To select **Auto Operation**, press the Operation Mode Selection button. Each time the button is pressed, the operation mode is shifted in the direction of the arrow.

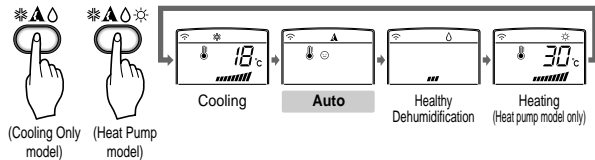

- 3 The temperature and fan speed are automatically set by the electronic controls based on the actual room temperature. If you want to change the set temperature, press the Room Temperature Setting buttons. The set temperature will be changed considering room temperature.

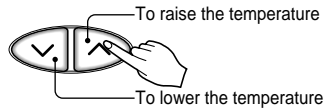

DURING AUTO OPERATION:

- ❑ You cannot switch the indoor fan speed. It has already been set by the Fuzzy rule.
- ❑ If the system is not operating as desired, manually switch to another mode. The system will not automatically switch from the cooling mode to the heating mode, or from heating to cooling, then you must set the mode and the desired temperature again.
- ❑ During Auto Operation, pressing the chaos swing button makes the horizontal louvers swing up and down automatically. If you want to stop auto-swing, press the chaos swing button again.



Healthy Dehumidification Operation

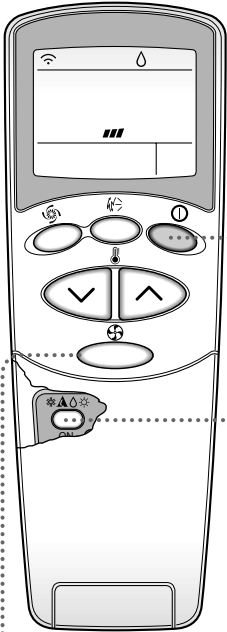

1 Press the Start/Stop button. The unit will respond with beep sound.



2 Open the door on the Remote Controller. To select **Healthy Dehumidification Operation**, press the Operation Mode Selection button. Each time the button is pressed, the operation mode is shifted in the direction of the arrow.

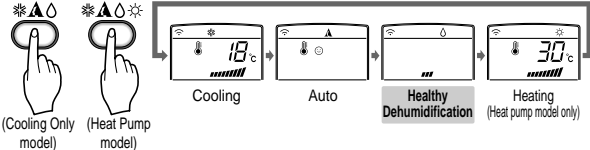

3 Set the fan speed. You can select the fan speed in four steps - low, medium, high, or CHAOS. Each time the button is pressed, the fan speed mode is shifted.



NATURAL WIND BY THE CHAOS LOGIC

- For more fresh feeling, press the Indoor Fan Speed Selector and set CHAOS mode. In this mode, the wind blows like natural breeze by automatically changing fan speed according to the CHAOS logic.

DURING HEALTHY DEHUMIDIFICATION OPERATION:

- If you select the dehumidification mode on the operation selection button, the A/C starts to run the dehumidification function, automatically setting the room temp. and air volume to the best condition for dehumidification based on the sensed room temp. In this case, the setting temp. is not displayed in the Remote Controller and you are not able to control the room temp. either.
- During the healthy dehumidification function, the air volume is automatically set according to the algorithm responding to the current room temp. and makes the room condition healthy and comfortable even in the high humidity season.



Heating Operation(Heat pump model only)

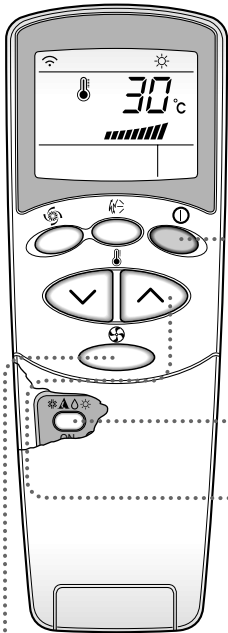

- 1** Press the Start/Stop button.
The unit will respond with beep sound.

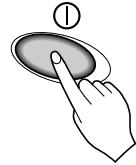

- 2** Open the door on the Remote Controller. To select **Heating Operation**, press the Operation Mode Selection button. Each time the button is pressed, the operation mode is shifted in the direction of the arrow.

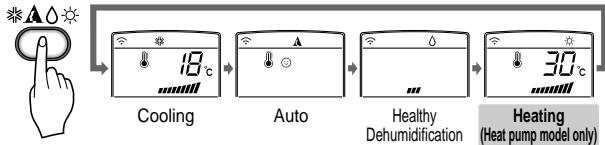

- 3** Set the temperature higher than the room temperature.
The temperature can be set within a range of 16°C~30°C(60°F~86°F) in 1°C(2°F).

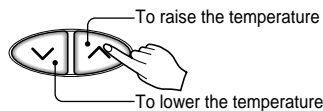

- 4** Set the fan speed again. You can select the fan speed in four steps—low, medium, high, or CHAOS. Each time the button is pressed, the fan speed mode is shifted.



NATURAL WIND BY THE CHAOS LOGIC

- For more fresh feeling than other fan speed, press the Indoor Fan Speed Selector and set to CHAOS mode. In this mode, the wind blows like natural breeze by automatically changing fan speed according to the CHAOS logic.



Jet Cool

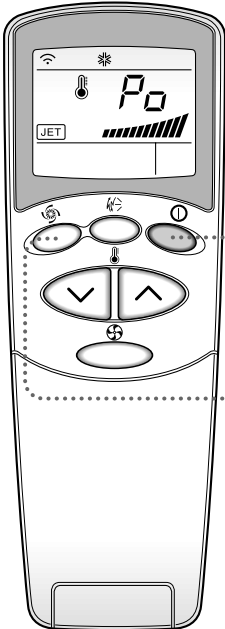

- 1 Press the Start/Stop button.
The unit will respond with beep sound.

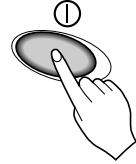

- 2 Press the **Jet Cool** button to operate the speed cooling/heating mode and the unit will operate in super high fan speed on cooling/heating mode for 30/60 minutes.



- 3 To cancel the **Jet Cool** mode, press the **Jet Cool** button or the fan button or the room temperature setting button again and the unit will operate in high fan speed in cooling/heating mode

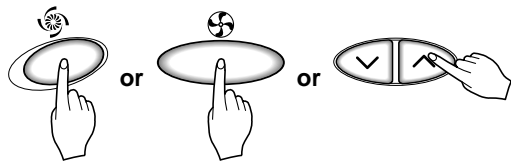

NOTICE

- ❑ *Jet Cool function in heating mode is available on Artcool type only.*
- ❑ *During the JET COOL function at any moment, the A/C starts to blow the cool/heat air at extremely high speed for 30/60 minutes setting the room temp. automatically to 18°C/30°C(64°F/86°F). It is especially used to cool/heat the room temperature in the shortest time.*
- ❑ *In order to return to the normal cooling/heating mode from the Jet Cool mode, you just press either the operation mode selection button, air volume selection or temp. setting button or the JET COOL button again.*

2ndF 2nd F Operation

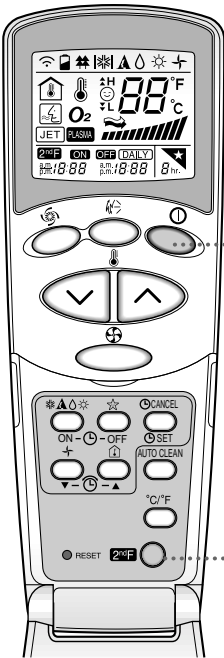

- 1** Press the Start/Stop button.
The unit will respond with beep sound.



- 2** Open the door of the Remote Controller and press the 2nd F button to operate functions printed in blue at bottom of buttons.
(Check the indication of 2nd function on Remote Controller display.)
These buttons operate the timer setting as follows:

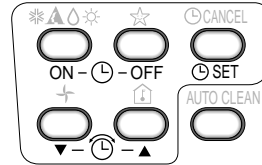

- 3** 2nd function goes off in a short time automatically or when the button is pressed again.

For more details, refer to functions next page.

Additional features

★ Sleep Mode

1. Press the Sleep Mode Auto button to set the time you want the unit to turn off automatically.



2. The Timer is programmed in one-hour increments by pressing the Sleep Mode Auto button 1 to 7 times.

The sleep mode is available for 1 to 7 times.
To alter the time period in steps of 1 hour, press the Sleep Mode Button while aiming at air conditioner.

3. Make sure the Sleep Mode Auto LED lights up.

To cancel the Sleep Mode, press the sleep Mode Auto button several times until the star (★) disappears from the operation display.

NOTICE The Sleep Mode will be operated at low fan speed (cooling) or medium fan speed (heat pump only) for quiet sleeping.

IN COOLING MODE: The temperature will automatically rise by 1°C (2°F) over the next 30 minutes and by 2°C (4°F) in 1 hour for comfortable sleeping.

🕒 Setting the Time

1. Time can be set only when you have pressed the Reset button. If you have just replaced the batteries, the Reset button should be pressed to reset the time.

Press the Start/Stop button.



2. Press the Time Setting buttons until the desired time is set.

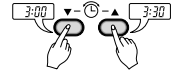

3. Press the Timer SET button.



NOTICE Check the indicator for A.M. and P.M.

🕒 Delay Start/Pre-Set Stop

1. Make sure the time is set correctly on the Remote Controller display.

2. Press the ON/OFF Timer buttons to turn Timer on or off.



3. Press the Time Setting buttons until the desired time is set.

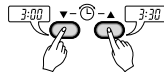

4. Press the selected on/off setting by pressing the Timer SET button while aiming the Remote Controller at the signal receptor.



To cancel the setting the timer.

Press the Timer Cancel button while aiming Remote Controller at the signal receptor. (The timer lamp on the air conditioner and the display will go out.)

NOTICE Select one of the following four types of operation.

with the unit running



Delay OFF Timer

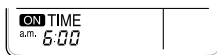

Delay ON Timer



Delay OFF and ON Timer



Delay ON and OFF Timer

Vertical Airflow Direction Control

The up/down airflow (Vertical Airflow) can be adjusted by using the remote control.

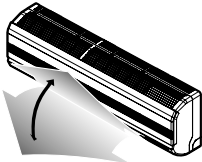

Press the Start/Stop button to start the unit.

Open the door on the remote control.

Press Chaos Swing button and the louvers will swing up and down. Press the Chaos Swing button again to set the vertical louver at the desired airflow direction.



NOTICE

- ❑ If you press the CHAOS swing button, the horizontal airflow direction is changed automatically based on the CHAOS algorithm to distribute the air in the room evenly and at the same time to make the human body feel most comfortable, as if enjoying a natural breeze.
- ❑ Always use the remote control to adjust the up/down airflow direction. Manually moving the vertical airflow direction louvers by hand could damage the air conditioner.
- ❑ When the unit is shut off, the up/down airflow direction louvers will close the air outlet vent of the system.

Air Circulation Mode

Circulates the room air without cooling or heating.

1. Press the Start/Stop button. the unit will respond with a beep.
2. Open the door on the remote control. Press the Air Circulation button. Close the door on the remote control. Now each time that you press the Indoor Fan Speed Selector, the fan speed is shifted from low to CHAOS and back to low again.

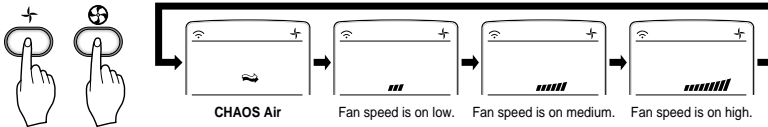

NOTICE

- ❑ **CHAOS Air** economizes power consumption and prevents overcooling. The fan speed is automatically changed from high to low or vice versa, depending on the ambient temperature.



Auto clean



1. Whenever you press the AUTO CLEAN button, Auto Clean Function will be selected or cancelled.
2. Auto Clean function works before and after cooling or dehumidification mode. For details, refer to the below points.
3. When the unit is started after selecting Auto Clean ,the Cool Start function operates and indoor Fan is started after 20 seconds.
4. When you press Start/Stop button to turn off the unit after the you have selected Auto Clean function, the air-conditioner circulates the indoor air in the Auto Clean mode with no more Cooling or Dehumidification operation. It lasts for 30 minutes.
5. If you press the AUTO CLEAN button again during the product operation , Auto Clean function will be cancelled.

NOTICE

- During Auto Clean function, moistures left in indoor units after Cooling Operation or Healthy Dehumidification Operation can be removed.
- During Auto Clean function, only Start/Stop button, Plasma button and AUTO CLEAN button are available.



Forced Operation

The operation will be started operation if the power button is pressed without remote controller. If you want to stop operation, re-press the button.

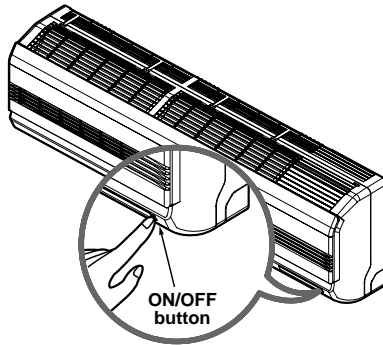

	Cooling Model	Heat pump Model		
		Room Temp. $\geq 24^{\circ}\text{C}(76^{\circ}\text{F})$	$21^{\circ}\text{C}(70^{\circ}\text{F}) \leq \text{Room Temp.} < 24^{\circ}\text{C}(76^{\circ}\text{F})$	Room Temp. $< 21^{\circ}\text{C}(70^{\circ}\text{F})$
Operating mode	Cooling	Cooling	Healthy Dehumidification	Heating
Indoor FAN Speed	High	High	High	High
Setting Temperature	$22^{\circ}\text{C}(72^{\circ}\text{F})$	$22^{\circ}\text{C}(72^{\circ}\text{F})$	$23^{\circ}\text{C}(74^{\circ}\text{F})$	$24^{\circ}\text{C}(76^{\circ}\text{F})$

Auto restart

In case the power comes on again after a power failure, the unit operates automatically to the previous operating conditions.

So there is no need of activating this function by pressing any key or button.

In the initial mode, the fan operates at a low speed and the compressor starts about 3 minutes later.

As the compressor starts, the fan speed also resumes its previous setting mode.



In case of absence for a long time while power failure, turn off main power to avoid undesired Auto restart.

NOTICE

This feature is enabled by factory default setting, but you can disable it by pressing the ON/OFF button for 6 seconds. The unit will beep twice and the indicator lamp(2) will blink 4 times.

To enable it, press the button again for 6 seconds. The unit will beep twice and the indicator lamp(1) will blink 4 times.

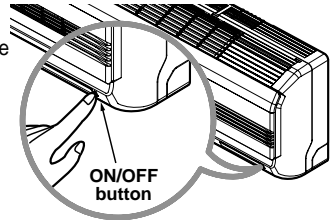

Helpful information

Fan speed and cooling capacity.

The cooling/heating capacity indicated in the specification is the value when the fan speed is set to high, and the capacity will be lower at low or medium fan speed.

High fan speed is recommended when you wish to cool/heat the room quickly.

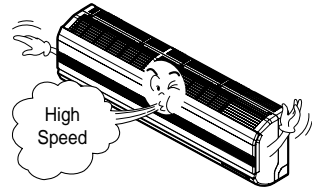

Maintenance and Service

CAUTION: Before performing any maintenance, turn off the main power to the system.

Indoor Unit

Grille, Case, and Remote Control

- ❑ Turn the system off before cleaning.
To clean, wipe with a soft, dry cloth. Do not use bleach or abrasives.

NOTICE Supply power must be disconnected before cleaning the indoor unit.

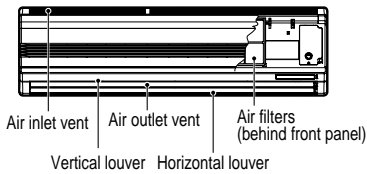

AIR FILTERS

The air filters behind the front grille should be checked and cleaned once in every 2 weeks or more often if necessary.

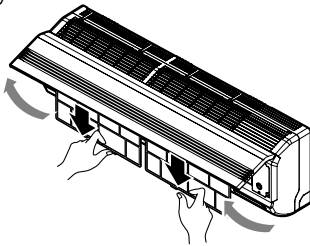

TRIPLE DEODORIZER filter

1. After removing the air filters, pull slightly forward to remove the TRIPLE DEODORIZING filter.
2. Dry in the sunlight for two hours.
3. Re-install the TRIPLE DEODORIZING filter to the original position.

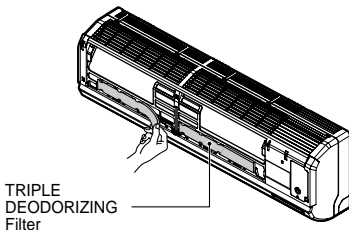

- ❑ Never use any of the followings:
 - Water hotter than 40°C(104°F)
Could cause deformation and/or discoloration.
 - Volatile substances
Could damage the surfaces of the air conditioner.

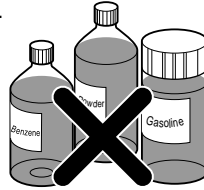

1. Lift the front access panel and pull the filter tab slightly forward to remove the filter.
2. Clean the filter with a vacuum cleaner or warm, soapy water.
 - If dirt is conspicuous, wash with a solution of detergent in lukewarm water.
 - If hot water (40°C (104°F) or more) is used, it may be deformed.
3. After washing with water, dry well in the shade.
4. Re-install the air filter.

When the air conditioner is not going to be used for a long time.

When air conditioner is not going to be used for a long time.

1. Operate the air conditioner on Air circulation mode (Refer to page 19) for 2 to 3 hours.
 - This will dry out the internal mechanisms.
2. Turn off the circuit breaker, and disconnect the power cable.



CAUTION: Turn off the circuit breaker when the air conditioner is not going to be used for a long time.

Dirt may collect and may cause a fire.

3. Remove the batteries from the Remote Controller.

When the air conditioner is to be used again.

1. Clean the air filter and install it in the indoor unit.
(Refer to page 22 for cleaning filters.)
2. Check that the air inlet and outlet of the indoor/outdoor unit are not blocked.

Operation Tips

Do not overcool the room.

This is not good for the health and wastes electricity.

Make sure that the doors and windows are shut tight.

Avoid opening doors and windows if possible to keep the cool air in the room.

Keep blinds or curtains closed.

Do not let direct sunshine enter the room when the air conditioner is in operation.

Clean the air filter regularly.

Blockages in the air filter reduce the airflow and lower cooling and dehumidifying effects. Clean at least once every two weeks.

Keep the room temperature uniform.

Adjust the vertical and horizontal airflow direction to ensure a uniform temperature in the room.

Ventilate the room occasionally.

Since windows are kept closed, it is a good idea to open them and ventilate the room now and then.

Troubleshooting

Check the following points before requesting repairs or service.... If the fault persists, please contact your dealer or service center.

Case	Explanation	See page
The air conditioner does not operate.	• Check room temperature setting?	12, 15
	• Check if circuit breaker is on?	-
The room has a peculiar odor.	• Check that this is not a damp smell exuded by the walls, carpet, furniture, or cloth items in the room.	-
It seems that condensation is leaking from the air conditioner.	• Check the drain hose is connected tight or if indoor unit is installed even.	-
Air conditioner does not operate for about 3 minutes after turning on.	<ul style="list-style-type: none"> • This is the protector of the mechanism. • Wait about 3 minutes and operation will begin. • About 3 minutes delay is applied to protect compressor from frequently on/off. 	-
Does not cool or heat effectively.	• Is the air filter dirty? See air filter cleaning instructions.	22
	• Has the temperature been set correctly?	12, 15
	• Are the indoor unit's air inlet or outlet vents obstructed?	-
The air conditioner operation is noisy.	<ul style="list-style-type: none"> • For a noise that sounds like water flowing. -This is the sound of refrigerant flowing inside the air conditioner unit. • For a noise that sounds like the compressed air releasing into atmosphere. -This is the sound of the dehumidifying water being processed inside the air conditioning unit. 	-
Remote Controller display is faint, or no display at all.	<ul style="list-style-type: none"> • Are the batteries depleted? • Are the batteries inserted in the opposite (+) and (-) directions? 	9
Crack sound is heard.	• This sound is generated by the expansion/constriction of the front panel, etc. due to changes of temperature.	-

Specifications and performance data subject to change without notice.

HEAT CONTROLLER, INC.

1900 WELLWORTH AVENUE • JACKSON, MICHIGAN 49203

THE QUALITY LEADER IN CONDITIONING AIR

P/No.: 3828A22236C