



# The Care Free<sup>®</sup> Warm Mist Humidifier



**Models 35201, 35202, 35203, 35253,  
36200, 36201, 36203, 36204, 36253**

[www.hunterfan.com](http://www.hunterfan.com)

ENGLISH  
See page 1

ESPAÑOL  
Ver la página 15

# READ AND SAVE THESE INSTRUCTIONS

Thank you for purchasing the Care Free® Warm Mist Humidifier by Hunter Fan Company. Please read and save these instructions to receive maximum benefit and performance from your humidifier.

**Important Safety Instructions:**  
**Read all instructions before using this humidifier.**

**CAUTION: To avoid electrical shock and/or fire, please read all instructions before use.**

1. This humidifier may not work properly on an uneven surface. **ALWAYS** place this humidifier on a firm, level, and water resistant surface. **ALWAYS** place the humidifier at least six (6) inches away from walls and heat sources, such as stoves, radiators, or heaters.
2. **ALWAYS** place the humidifier in an area that is out of the reach of children.
3. Before using the humidifier, extend the cord and inspect for any sign of damage. **DO NOT** use the product if the cord has been damaged.
4. This product has a polarized plug as a safety feature (one blade is wider than the other). This plug will fit into a polarized outlet only one way. If the plug does not fully fit into the outlet, reverse the plug. If it still does not fit, contact a qualified electrician. **DO NOT** attempt to defeat or override this feature.
5. **ALWAYS** unplug and empty the humidifier when it is not in operation or while it is being cleaned.
6. **DO NOT** tilt or move the humidifier while it is in operation. Never move the humidifier while there is water in the tank. Empty the water tank, turn the unit off, and unplug the unit before moving.
7. In addition to routine maintenance which may be required, this humidifier requires seasonal cleaning. Refer to and follow the instructions for **CLEANING THE HUMIDIFIER AND THE WATER TANK.**
8. This unit was designed to be used with distilled and/or tap water. **DO NOT** add scented oils, perfumes or fragrance additives to the water.
9. **DO NOT** attempt to move or disassemble the Base while there is hot water still in the unit. Allow a minimum of fifteen (15) minutes cooling time before moving or disassembling the Base.
10. **ALWAYS** use clean, cool tap water to fill the Water Tank.
11. To avoid the risk of electrical shock, **DO NOT** use an extension cord.
12. **DO NOT** operate outdoors. This humidifier is for indoor use only.
13. **DO NOT** let water get into the air inlets on the back of the enclosure, the cord, or the plug.
14. **DO NOT** store or use gasoline or other flammable vapors and liquids near the humidifier.
15. **DO NOT** touch hot surfaces. **DO NOT** place hands or face directly over the Exhaust Grille while the unit is in operation.
16. **DO NOT** allow the Exhaust Grille to directly face a wall surface. Direct mist aimed at a wall could cause damage, particularly to wallpaper.

# How The Care Free® Warm Mist Humidifier Works

The Care Free® Warm Mist Humidifier has a unique, patented design with several innovative features:

- **Removable Boiling Chamber** – The detachable heater can be easily removed for cleaning and maintenance.
- **Humidification System** – Water is passed through a heating element which creates warm mist to humidify the air. Stagnant water in the reservoir is eliminated due to minimal water quantity in the boiler reservoir.
- **Built-In Antimicrobial Properties** – The plastic parts in this humidifier have built-in antimicrobial properties to inhibit the growth of bacteria, mold and fungi that may affect these parts.

**NOTE:** The antimicrobial properties built into this humidifier do not extend to the

water, humidified air or users. Conduct routine cleaning and maintenance based upon use and individual conditions.

- **No White Dust** – The Care Free® Warm Mist Humidifier produces no white dust that can settle on furniture or be inhaled.

**NOTE:** You may notice mineral deposits accumulating in the tank base or on other components. This is normal and comes with regular usage conditions. If you would like to remove these deposits and maintain humidifier performance, please see the section **CLEANING THE HUMIDIFIER AND THE WATER TANK**.

- **Dishwasher Safe** – All components of The Care Free® Warm Mist Humidifier are top-rack dishwasher safe, except for the powered base.

## Assembly Of Humidifier Parts

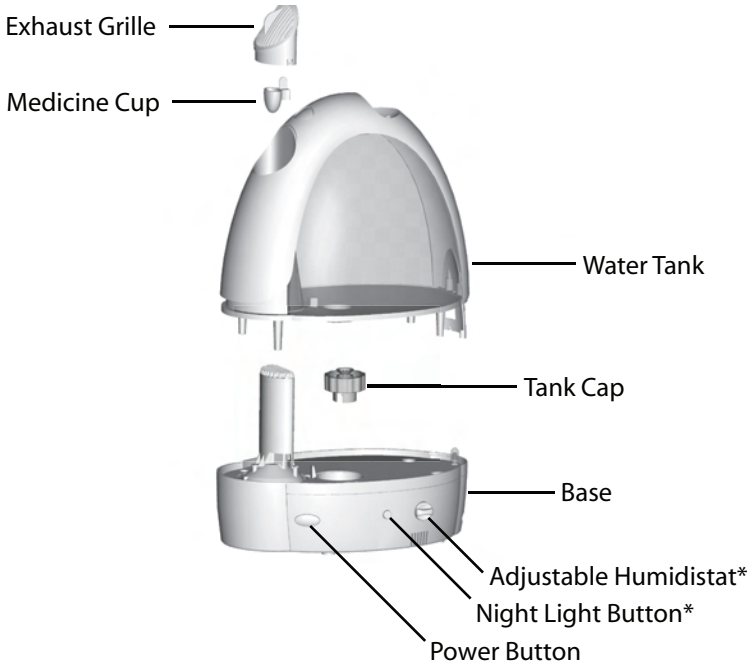

\*Not available on all models

1. Remove the Care Free® Warm Mist Humidifier from its packaging.
2. Select a location for your humidifier. The location should be flat, hard, water-resistant, and at least six (6) inches away from walls and sources of heat. Mount the humidifier on a drip tray if you are using the unit on a wood surface or other surface which could be damaged by accidental water spillage or condensation.

**HUNTER WILL NOT ACCEPT RESPONSIBILITY FOR DAMAGE DUE TO WATER SPILLAGE.**

3. Place the Base in the location you selected. Take the Water Tank to a sink or tub to fill with water.
4. Unscrew the Tank Cap by twisting it counterclockwise and fill the Water Tank with fresh, cool water. **NEVER USE HOT WATER.**



5. Replace the Tank Cap by screwing it clockwise onto the Water Tank.

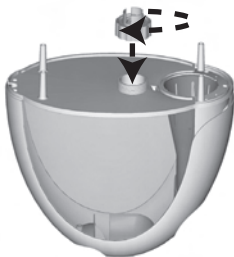

6. Place the Water Tank back onto the Base. Make sure the Water Tank is properly seated on the Base or the humidifier will not work properly.

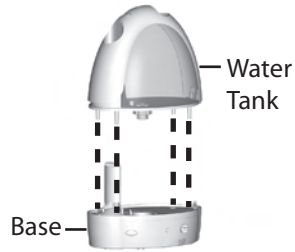

**HUNTER WILL NOT ACCEPT RESPONSIBILITY FOR DAMAGE DUE TO WATER SPILLAGE.**

7. Make sure the Power Button is set to OFF and plug the humidifier into the wall outlet.

**CAUTION: Never plug in the humidifier while your hands are wet, as electric shock could occur.**

**NOTE: Let the humidifier sit for one minute after refilling the tank, before turning the power back ON.**

8. Push the Power Button to turn the humidifier ON. Adjust the setting as needed.

# Operating Your Humidifier

There are two humidity level controls:

1. **Adjustable Humidistat\*** – Allows you to adjust the humidity setting.



Turn the dial to the right to increase humidity.  
Turn the dial to the left to decrease humidity.

**NOTE:** In a very dry room, the HI setting should be used to quickly achieve a comfortable level of humidity. Once the room is at the desired humidity level, you can turn the Adjustable Humidistat down. We suggest you begin with a middle setting and adjust the level using the Adjustable Humidistat to suit your needs.

2. **Power Button** – Sets humidity to HIGH, LOW, or OFF.

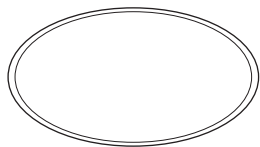

Push the Power Button on the base of the unit **ONCE** to turn the humidifier ON. A green indicator light will be illuminated, which indicates a HIGH setting.

**NOTE:** It may take 2-3 minutes for the humidifier to warm up and begin to release warm mist.

Push the Power Button on the base of the unit **AGAIN** to change the setting to LOW. A yellow indicator light will be illuminated, which indicates a LOW setting.

Push the Power Button on the base of the unit **AGAIN** to turn the humidifier OFF. No indicator light will be illuminated, which indicates the unit has been turned OFF.

3. **NiteGlo™ Night Light Button\*** – Illuminates with a soft blue glow.

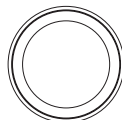

Push the NiteGlo™ Button to turn the light ON or OFF. The night light can be operated even when the humidifier is OFF.

\*Not available on all models.

# Refilling The Water Tank

1. When the water level is low, push the **POWER** button to turn the humidifier **OFF** and unplug the humidifier.

**NOTE:** When the tank level is too low, the humidifier will turn **OFF** and display a red light.



Low Water Level Light (Red)

2. Lift the Water Tank and take it to the sink or a tub to refill.
3. Turn the Water Tank over and unscrew the Tank Cap by twisting it counterclockwise.



4. Empty the Water Tank and refill it with fresh, cool water. **NEVER USE HOT WATER.**

5. Replace the Tank Cap by screwing it clockwise onto the Water Tank. Make sure that the tank cap is properly seated before screwing it back onto the tank to ensure a proper seal.



6. Place the Water Tank back onto the Base. Make sure the Water Tank is properly seated on the Base or the humidifier will not work properly.

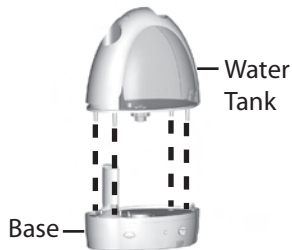

**HUNTER WILL NOT ACCEPT RESPONSIBILITY FOR DAMAGE DUE TO WATER SPILLAGE.**

7. Make sure the Power Button is set to **OFF** and plug the humidifier into the wall outlet.

**CAUTION:** Never plug in the humidifier while your hands are wet, as electric shock could occur.

**NOTE:** Let the humidifier sit for one minute after refilling the tank, before turning the power back **ON**.

8. Push the Power Button to turn the humidifier **ON**. Adjust the setting as needed.

# Reassembly Of Humidifier Parts

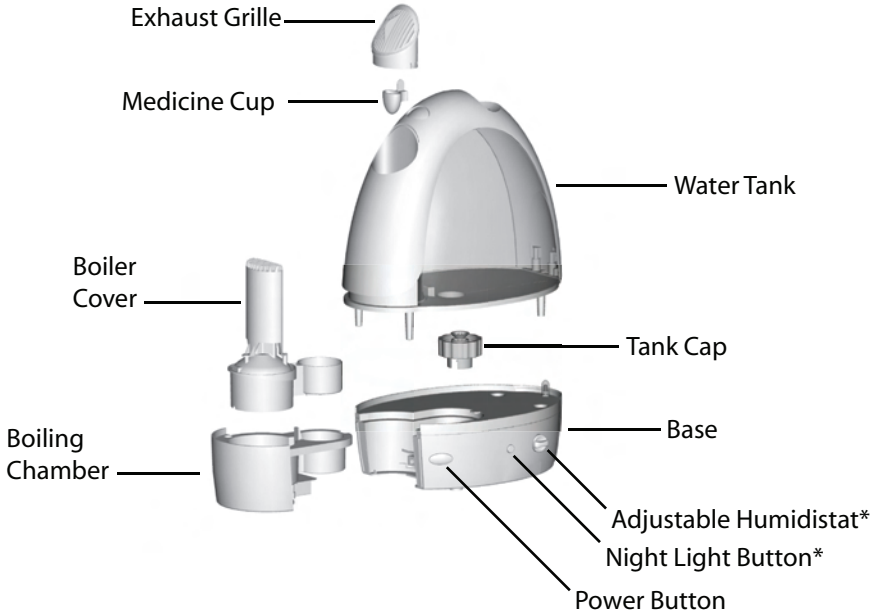

\*Not available on all models

## Cleaning The Humidifier And The Water Tank

Many regions have hard water with high concentrations of minerals. When water evaporates from the Care Free® Warm Mist Humidifier, minerals may be left behind. These minerals can form a hard white scale which can be removed by following the cleaning instructions. The frequency of cleaning due to mineral build up varies depending on the quality of water you have. Failure to perform the necessary cleaning steps can damage the unit and affect performance.

**NOTE:** The Water Tank, Tank Cap, Medicine Cup, Boiler Cover, Boiling Chamber, and Exhaust Grille are dishwasher safe in the top rack only.

1. Push the **POWER** button to turn the unit **OFF** (the indicator light will be **OFF**) and unplug the humidifier.
2. Remove the Water Tank and carry it to a

sink or a tub. Unscrew the Tank Cap by twisting it counterclockwise and empty any water in the Water Tank.

### 3. **CAUTION: HEATING ELEMENT MAY BE EXTREMELY HOT.**

Allow at least fifteen (15) minutes for the hot water in the Boiling Chamber to cool after turning the humidifier **OFF** before moving the Base or removing the Boiling Chamber from the Base. Pull the Boiling Chamber away from the Base to remove the Boiling Chamber.

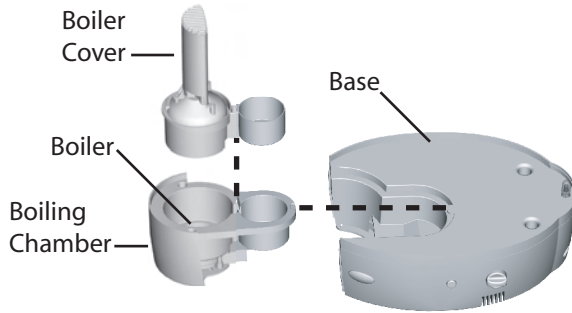

4. Place the Boiling Chamber into an empty sink and carefully lift the Boiling Chamber Cover by pressing the Chamber Cover Release Tab. This will expose the Heater. Drain all water and rinse with cool, clean water. Use a soft brush or sponge to clean the Boiling Chamber and the Boiling Chamber Cover.
5. Pour one (1) cup of white vinegar into the Boiling Chamber and allow it to soak for 20-30 minutes. Rinse several times with cool, clean water. Wipe the Boiler clean if necessary.
6. Before reinstalling the Boiling Chamber, make sure the three metal pins in the Chamber are clean and completely dry. Place the Boiling Chamber Cover into the Boiling Chamber and slide the Chamber slowly back into place. Make sure the Chamber fits properly in the Base.
7. To disinfect the Water Tank, create a solution of one (1) cup of white vinegar and one (1) gallon of clean water. Fill the Water Tank with the solution and allow it to soak for 20 minutes, occasionally swishing the solution to wet all interior surfaces. Empty the Water Tank completely and rinse with clean water several times. Refill the Water Tank with cool, clean water and place it back on the humidifier Base.
8. **NEVER** use any metal or hard object, which could cause scratching of the

humidifier surface, to clean plastic parts. **NEVER** use gasoline, kerosene, glass cleaner, furniture polish, paint thinner, or other household solvents to clean any part of the humidifier.

9. The Water Tank should be drained EACH DAY, rinsed, and refilled with clean tap water.
10. To clean the exterior surfaces, use a solution of water and mild detergent with a damp cloth. Rinse the surfaces with clean water and dry with a cloth. Allow sufficient time to dry before plugging the electrical cord back into the outlet.
11. Place the Water Tank back onto the Base and resume normal use.

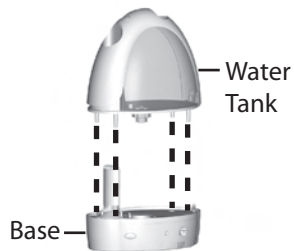



# Storage Tips

If you do not plan to use your humidifier for an extended period of time, such as during the summer months, it is important that you follow these instructions to help prevent problems from developing in the unit.

1. Clean your humidifier as outlined in the CLEANING THE HUMIDIFIER AND THE WATER TANK section.
2. Make sure all water is emptied from

the tank and the hot and cold water reservoirs.

3. Make sure the unit is completely dry.
4. Leave the Tank Cap off to expose the Water Tank to air.
5. Pack the humidifier in the original carton and store it in a cool, dry place.

## Troubleshooting

### • Problem: Humidifier not misting.

#### Solution:

1. Make sure the unit is plugged in.
2. Check the circuit breaker or fuses.
3. Adjust the humidity level using the Power Button and the Adjustable Humidistat. Once the room reaches the set humidity level, the humidifier will turn OFF; this is normal.
4. Remove and refill the Water Tank.
5. Reposition the Water Tank on the Base.

### • Problem: Humidity output and water usage decreased.

#### Solution:

1. Check the Adjustable Humidistat and Power Button to make sure they are set to the desired humidity level.
2. Clean any components that have mineral build-up. Refer to the section on CLEANING THE HUMIDIFIER AND THE WATER TANK.

If you have questions or problems, please call 1-888-830-1326 for assistance before returning the unit to the retailer.

## Service Parts

To obtain a service part for your humidifier, call Hunter Customer Service at 1-888-830-1326 or e-mail us at [Techsupport@hunterfan.com](mailto:Techsupport@hunterfan.com). Please be prepared to tell the operator the model number of your humidifier, the name of the part you need to replace, and the part number.

Model Number	Boiler Cover	Exhaust Grille	Medicine Cup	Tank Cap	Water Tank
35201, 35202, 36200, 36201, 36204	96362-01-325	86731-01-325	75690-01-325	83736-01-325	96361-01-326
35203, 36203	96362-01-325	86731-01-325	75690-01-325	83736-01-325	96361-01-504
35253, 36253	96362-01-502	86731-01-502	75690-01-502	83736-01-502	96361-02-326

# Hunter Fan Company The Care Free® Warm Mist Humidifier 3 Year Limited Warranty

---

Hunter Fan Company, Inc. makes the following warranty to the original residential user or consumer purchaser of the Care Free® Warm Mist Humidifier.

If any part of the Care Free® Warm Mist Humidifier ("Humidifier") fails during the first three (3) years from the date of installation due to a defect in material or workmanship, we will provide a replacement part free of charge. If no replacement part can be provided, we will replace your humidifier.

If your humidifier fails anytime within one (1) year after the date of installation due to a defect in material or workmanship, labor to repair the defect will be provided free of charge at our nearest service center or at our Service Department in Memphis, Tennessee. You will be responsible for all parts and labor costs after this one year period.

If your humidifier water tank, boiler cover, boiling chamber, base, knobs or tank cap fail at any time within one (1) year after the date of sale to you due to a defect in material or workmanship, we will repair, or at our option, replace the water tank, boiler cover, boiling chamber, base, knobs or tank cap free of charge for parts or labor at our nearest service center or at our Service Department in Memphis, Tennessee.

IF THE ORIGINAL RESIDENTIAL USER OF CONSUMER PURCHASER CEASES TO OWN THE HUMIDIFIER, THIS WARRANTY AND ANY IMPLIED WARRANTY WHICH THEN REMAINS IN EFFECT, INCLUDING BUT NOT LIMITED TO IMPLIED WARRANTY OF MERCHANTABILITY OR FITNESS FOR A PARTICULAR PURPOSE, ARE VOIDED.

NO WARRANTY, EXPRESSED OR IMPLIED, INCLUDING ANY WARRANTY OF MERCHANTABILITY OR FITNESS FOR A PARTICULAR PURPOSE, IS MADE IN RESPECT TO THE FILTER.

THE WARRANTY IS IN LIEU OF ALL OTHER EXPRESS WARRANTIES. THE DURATION OF ANY IMPLIED WARRANTY, INCLUDING BUT NOT LIMITED TO ANY IMPLIED WARRANTY OF MERCHANTABILITY OR FITNESS FOR A PARTICULAR PURPOSE, IN RESPECT TO THE MOTOR IS EXPRESSLY LIMITED TO THE PERIOD OF THE EXPRESS WARRANTY SET FORTH ABOVE.

This warranty is voided if your humidifier is not purchased and used in the USA or Canada.

This warranty excludes and does not cover defects, malfunctions or failures which were caused by repairs by persons not authorized by Hunter Fan Company, or accessories not authorized by Hunter Fan Company, mishandling, modifications, or damage to the

humidifier while in your possession, or unreasonable use, including failure to provide reasonable and necessary maintenance. This warranty does not cover humidifiers used in commercial applications. There are no express or implied warranties as to commercial purchasers or users.

## Technical Support

If you have any additional questions or problems with your Hunter Air Purifier, please call 1-888-830-1326 from 8:00 am to 5:00 pm Central Time or contact us over the Internet at [www.hunterfan.com](http://www.hunterfan.com). **You will be responsible for insurance and freight or other transportation to our factory service center. We will return the humidifier, freight prepaid, to you. The humidifier should be properly packaged to avoid damage in transit since we will not be responsible for any such damage. Proof of purchase is required when requesting warranty service. The purchaser must present the sales receipt or other documentation that establishes proof of purchase.**

**IN NO EVENT SHALL HUNTER FAN COMPANY BE LIABLE FOR DIRECT, INDIRECT, SPECIAL, CONSEQUENTIAL OR INCIDENTAL DAMAGES IN EXCESS OF THE PURCHASE PRICE OF THE HUMIDIFIER. YOUR SOLE REMEDY WILL BE REPAIR OR REPLACEMENT AS PROVIDED ABOVE.**

**SOME AMERICAN STATES AND CANADIAN PROVINCES DO NOT ALLOW:**

- **LIMITATIONS ON HOW LONG AN IMPLIED WARRANTY LASTS**
- **THE EXCLUSION OR LIMITATION OF DIRECT, INDIRECT, SPECIAL, INCIDENTAL OR CONSEQUENTIAL DAMAGES**
- **THE EXCLUSION OR INVALIDITY OF EXPRESS OR IMPLIED WARRANTIES IF THE USER CEASES TO OWN THE HUMIDIFIER**
- **THE LIMITATION OF REMEDIES AND RECOURSES AVAILABLE TO THE PURCHASER, OR**
- **THE INVALIDITY OF AN EXPRESS WARRANTY WHEN A PRODUCT IS IDENTIFIED BY BRAND NAME IS NOT USED (UNLESS SPECIFIC CONDITIONS ARE FULFILLED)**

**SOME THE ABOVE LIMITATIONS OR EXCLUSIONS MAY NOT APPLY TO YOU.**

## Other Home Comfort Products from Hunter

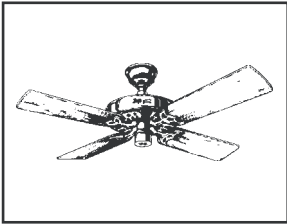

Hunter Original®

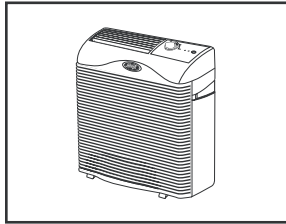

QuietFlo™ HEPA Air  
Purifier

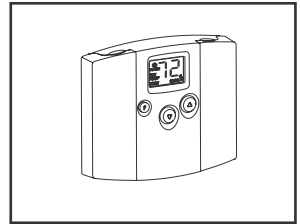

Programmable  
Thermostat

To learn more about Hunter Fan products, visit our web page at:  
[www.hunterfan.com](http://www.hunterfan.com)



SINCE 1886

HUNTER FAN COMPANY  
2500 FRISCO AVENUE  
MEMPHIS, TN 38114, USA