

This Owner's Manual is provided and hosted by [Appliance Factory Parts](#).

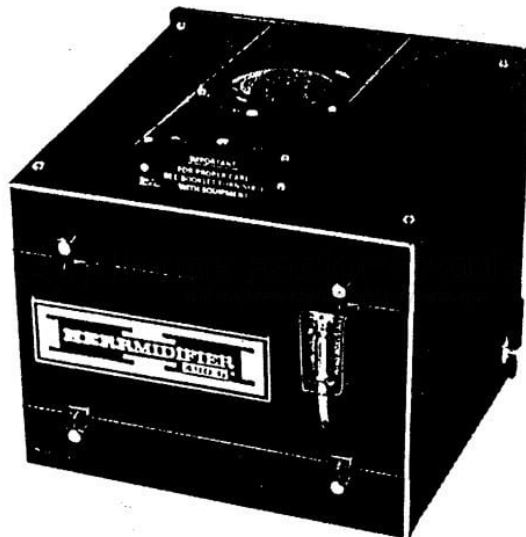

HERRMIDIFIER 490-6 Owner's Manual

[Shop genuine replacement parts for HERRMIDIFIER
490-6](#)



[Find Your HERRMIDIFIER Humidifier Parts - Select From 41 Models](#)

----- Manual continues below -----

READ AND SAVE THESE INSTRUCTIONS
OWNER'S MANUAL

*Installation, Operation and
Maintenance Instructions*

**MODEL 490-6
HERRMIDIFIER**



*1024 Gauge & Tube
& Brommat*

Also list 1025

1021 Rings

Supports Evap Pads

USED IN HOT AIR PLENUM OF WARM AIR FURNACES
FOR COMPLETELY AUTOMATIC HUMIDITY CONTROL.



Herrmidifier Company, Inc.
1812 Colonial Village Lane
P.O. Box 11148
Lancaster, PA 17605-1148

PRINTED IN U.S.A.

PROPER LOCATION FOR MODEL 490-6 HERRMIDIFIER

1. The BEST location is in the warm air plenum near the jacket.
2. It can be installed in the hot air duct of a single duct system close to the plenum.
3. Do NOT install the HERRmidifier where the furnace opens for access to the burner.
4. Install in cold air plenum of counterflow furnace. (Capacity of unit will be lower due to cooler air.)
5. Do not install close to flue pipe, intense heat at one spot of case can damage unit.
6. If plenum has Air Conditioning Coil, mount unit to discharge into slanted tube bank, NOT into coil end plate.

 MODEL 490-6 LOCATION

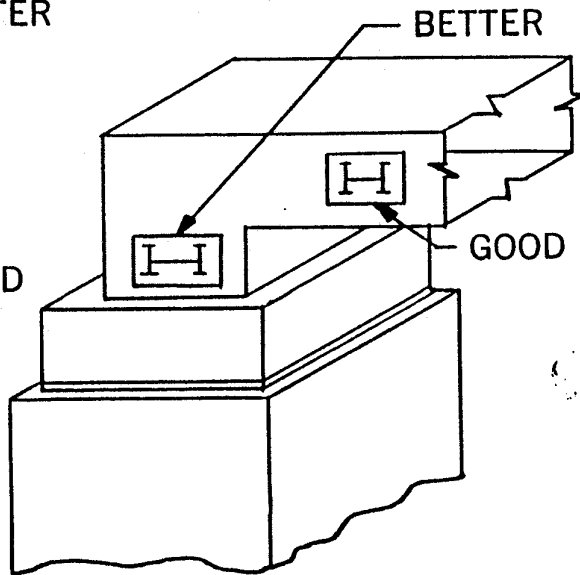
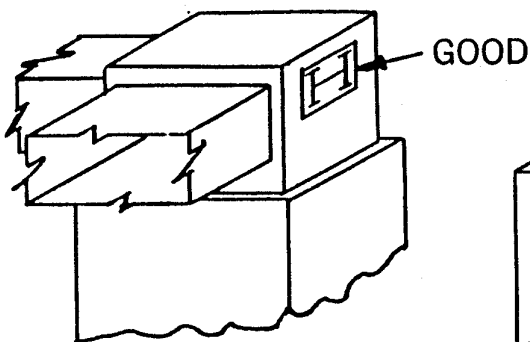
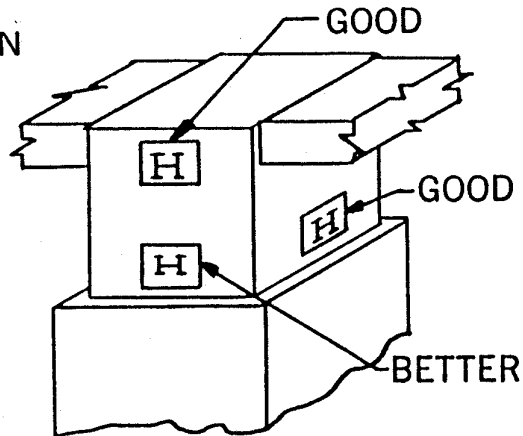
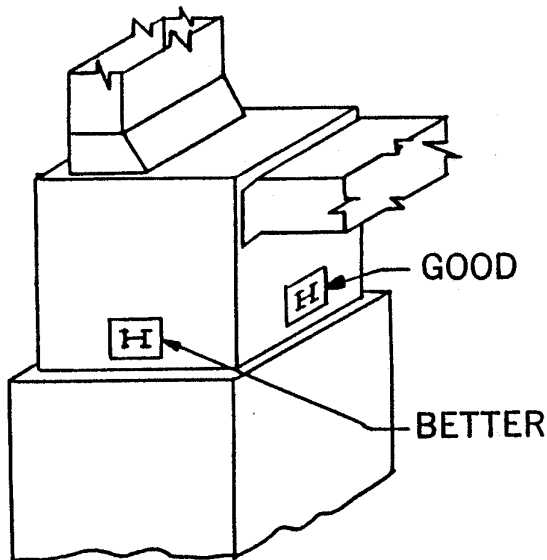

INSTALLATION

A compact and self contained unit, the Model 490-6 can be completely installed and ready for water and electrical connections in a matter of minutes. The model 490-6 is an attractive unit that requires only a minimum amount of space without any relays or outboard ductwork. Use of the bleed-off drain is recommended for best results; however, in good water areas, excellent results can be obtained without it.

The actual installation of the Model 490-6 is extremely simple and can be accomplished quickly and easily. The simplified mounting plate eliminates the need to balance the entire unit in its proper position while it is being fastened. This reduces the time required for installation.

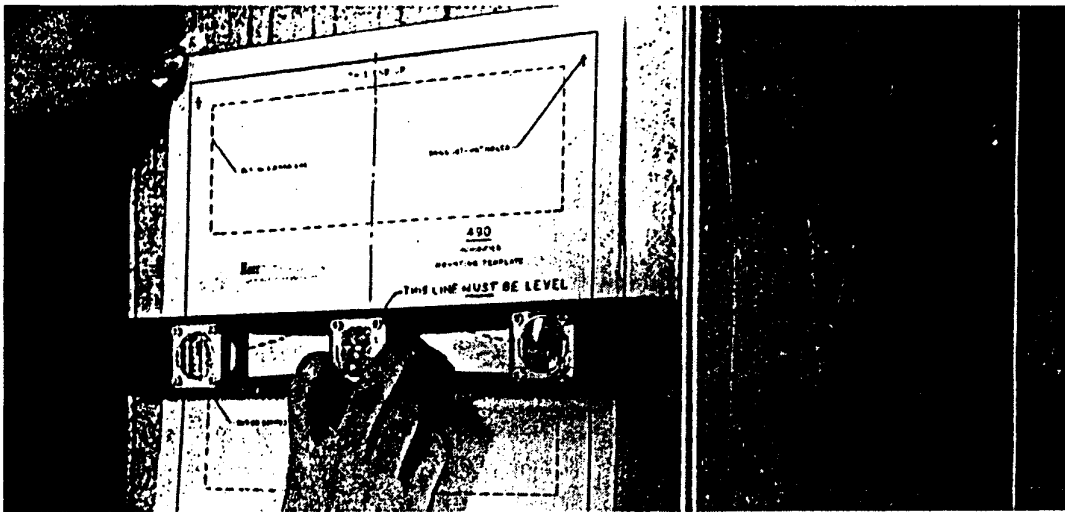

Step 1. Secure template on plenum using adhesive strips provided.

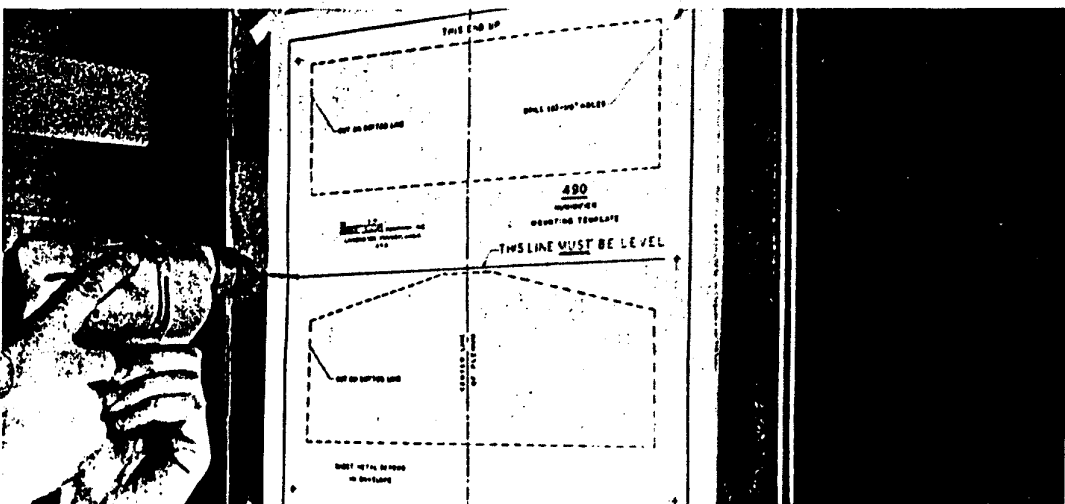

Step 2. Drill six (6) 1/8" diameter holes on template as marked.

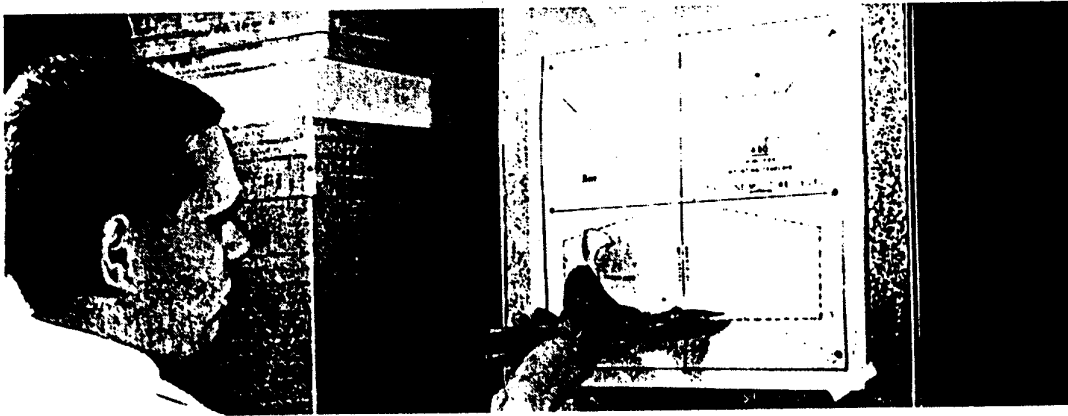

**Step 3. Cut out area of plenum as marked on template.
DO NOT CUT THE OPENINGS UNDERSIZE.**



**Step 4. Remove the template and Straighten the metal edges of
the plenum so the mounting plate will fit tightly in place.**



**Step 5. Fix the mounting plate in position with the six (6) sheet
metal screws provided.**

**Note: If holes strip, six (6) Tinnerman Nuts have been pro-
vided so Mounting Plate can be securely fastened.**

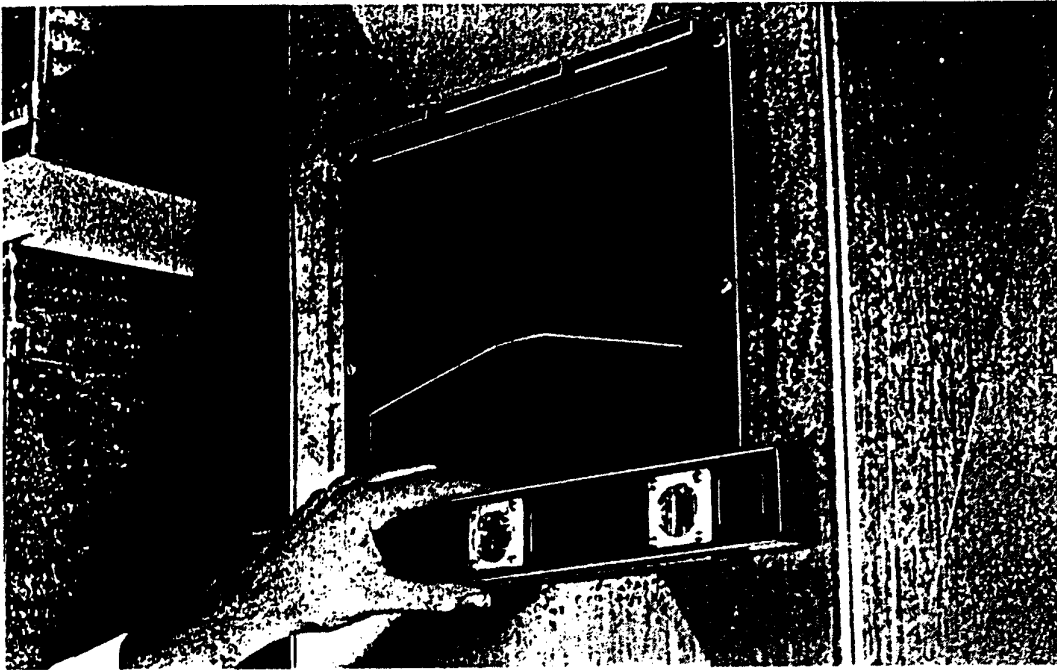

Step 6. Check the level of the mounting plate from left to right with a spirit level and adjust as required by loosening screws and moving the mounting plate. Slots have been provided.

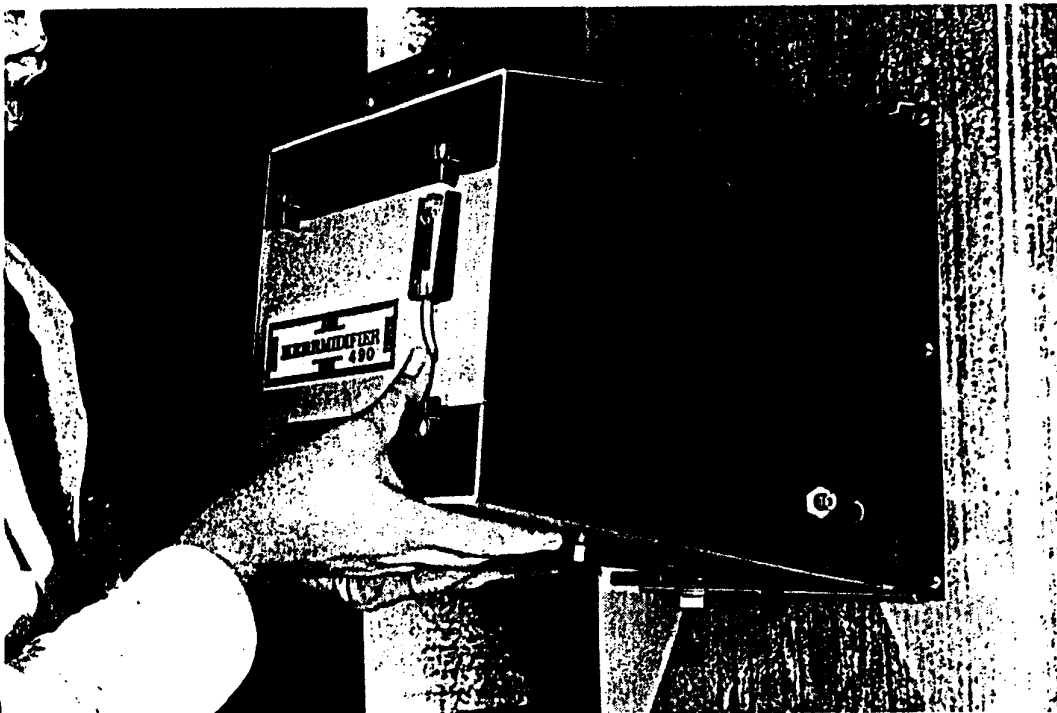

Step 7. Position the unit on the mounting plate by pushing the upper case lip into the upper plate groove, then lower the bottom case lip into the bottom plate groove. Be sure the unit is seated along the full length of the groove.

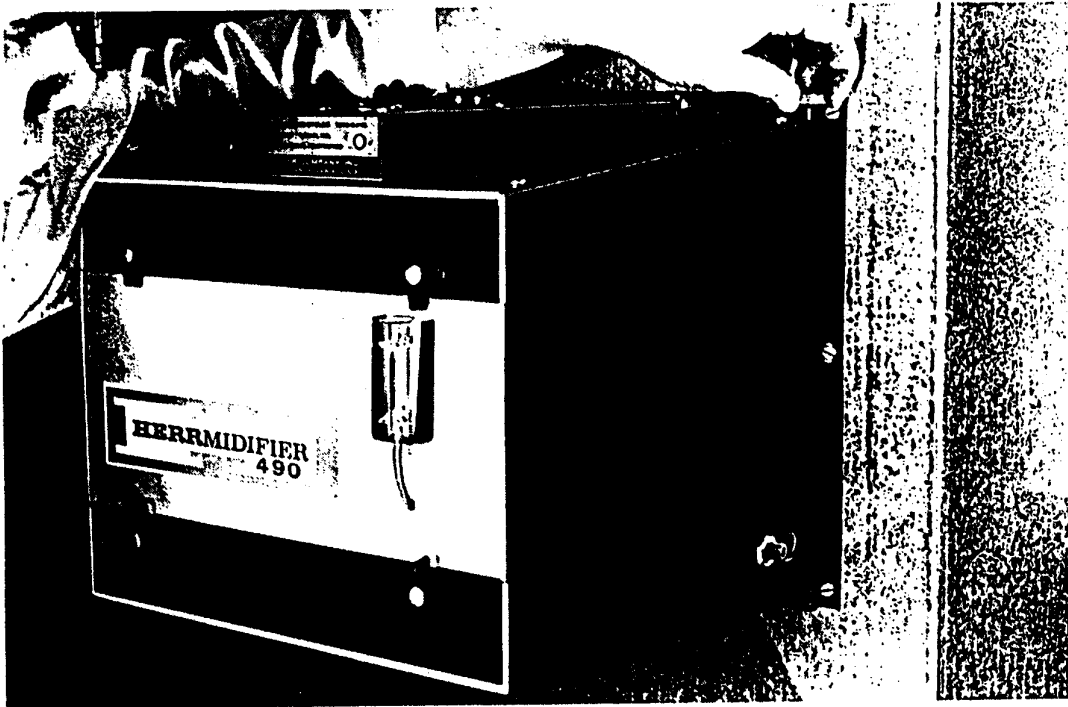

Step 8. Secure the case on the mounting plate with the two black safety clips provided.

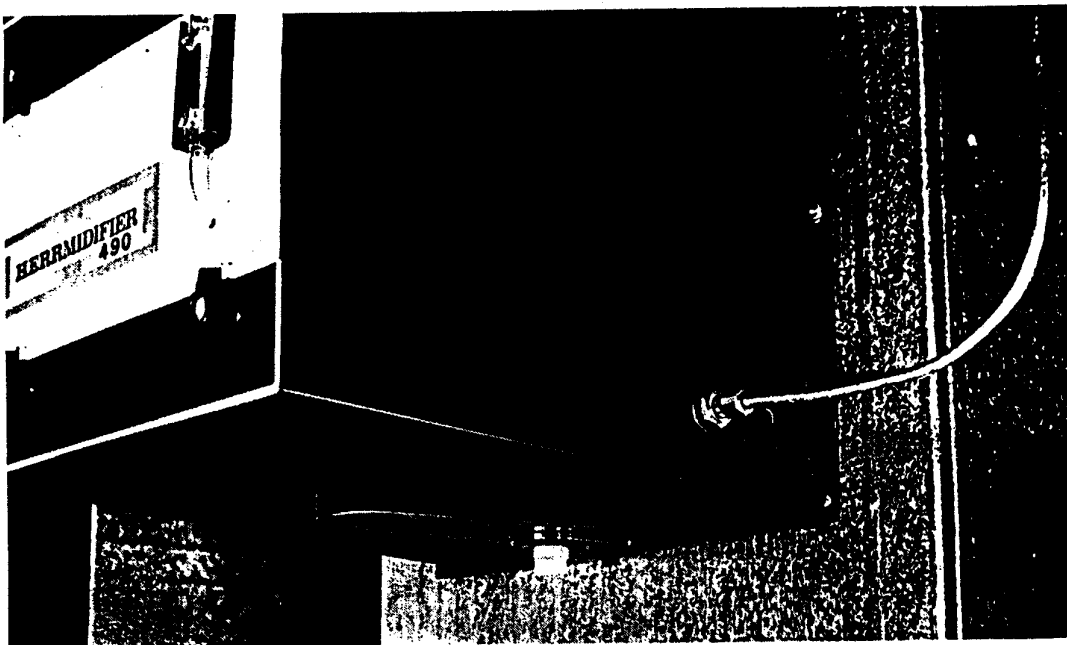

Step 9. Run 1/4" copper water line from water supply pipe using self tapping saddle valve provided and attach to water connection on outside of case. Either hard or softened water may be used.

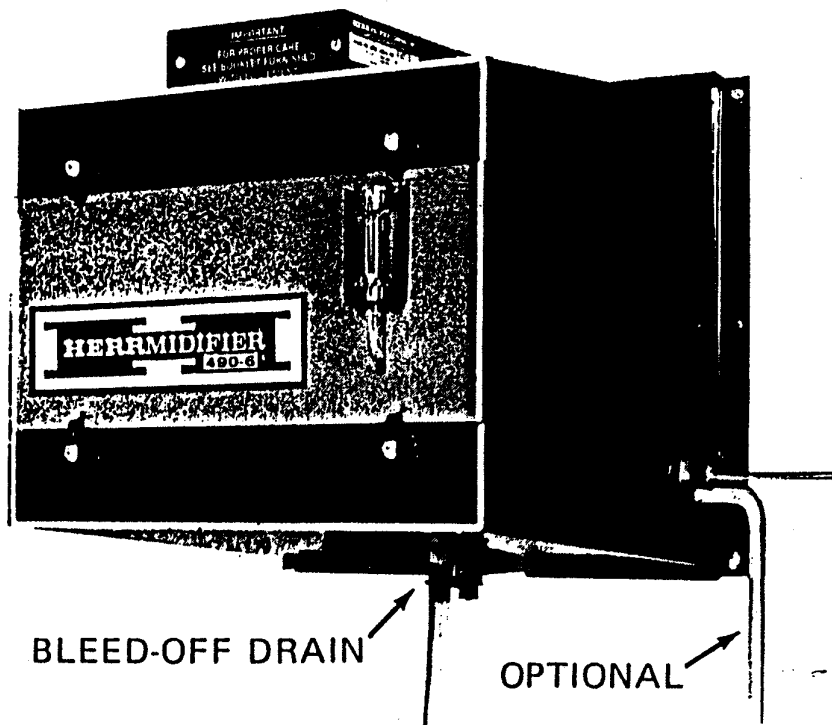

Step 10. Attach plastic hose to bleed-off drain of unit and connect to any open drain. Do NOT solder directly to drain in case of unit as heat can damage plastic. Plastic hose and clamps supplied fit 1/2" O.D. copper tube.

Note: In good water areas, this bleed-off drain is not mandatory. It can be capped, if not used. (Cap provided)

OPTION: The overflow hole near the float valve and water line has been tapped for 1/2" O.D. copper drain. It is recommended that this drain be installed and connected to an open drain. When installing drain, remove brass shield (located inside the case) which covers threaded overflow hole.

IMPORTANT: Always install an overflow drain when using the unit on electric warm air furnace or where accidental overflow could cause water damage.

NOTE: Tighten fittings in case with a small wrench. Use just enough force to make a water tight joint. Excessive force can damage the case and is not required.

Step 11. Turn on water and check saddle valve and line for leaks. Correct as required.

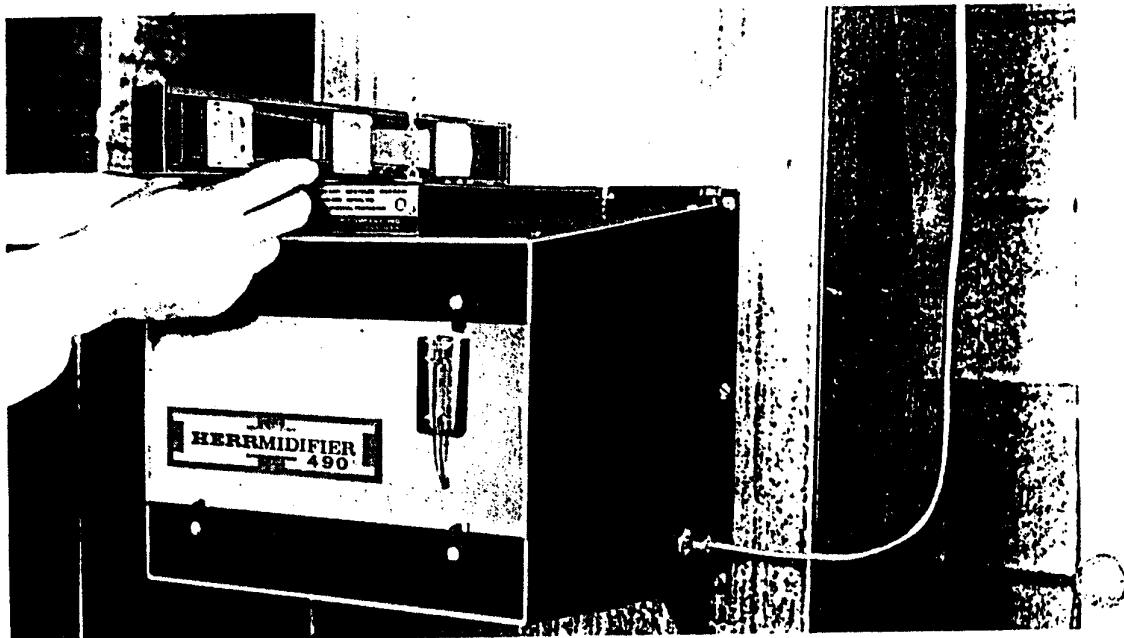

Step 12. Unit should be approximately level. Check with spirit level and, if required, support unit from leveling screw to overhead joist with chain or wire.

Step 13. Remove door on front of case by rotating latches counter-clockwise $\frac{1}{4}$ turn - a screwdriver may be needed to loosen latch screws. Remove shipping tape and cardboard from pump. When the float-valve is closed, water should be at level indicated on sticker. Adjust as required with thumb screw. Check evaporator pad (bottom) and filter pad (top) to be sure each is resting on tracks on side of case (see illustration on page 11). Replace door. Be sure latch screws are tightened with screwdriver.

Step 14. Install humidistat in accordance with instructions provided with the control. The humidistat may be the duct type mounted in a return air duct or the wall type mounted in a room of the house.

NOTE: Always use a humidistat with the Model 490-6.

Step 15. Remove the cover plate from the junction box at the top of the humidifier case. The motor has been grounded at the factory.

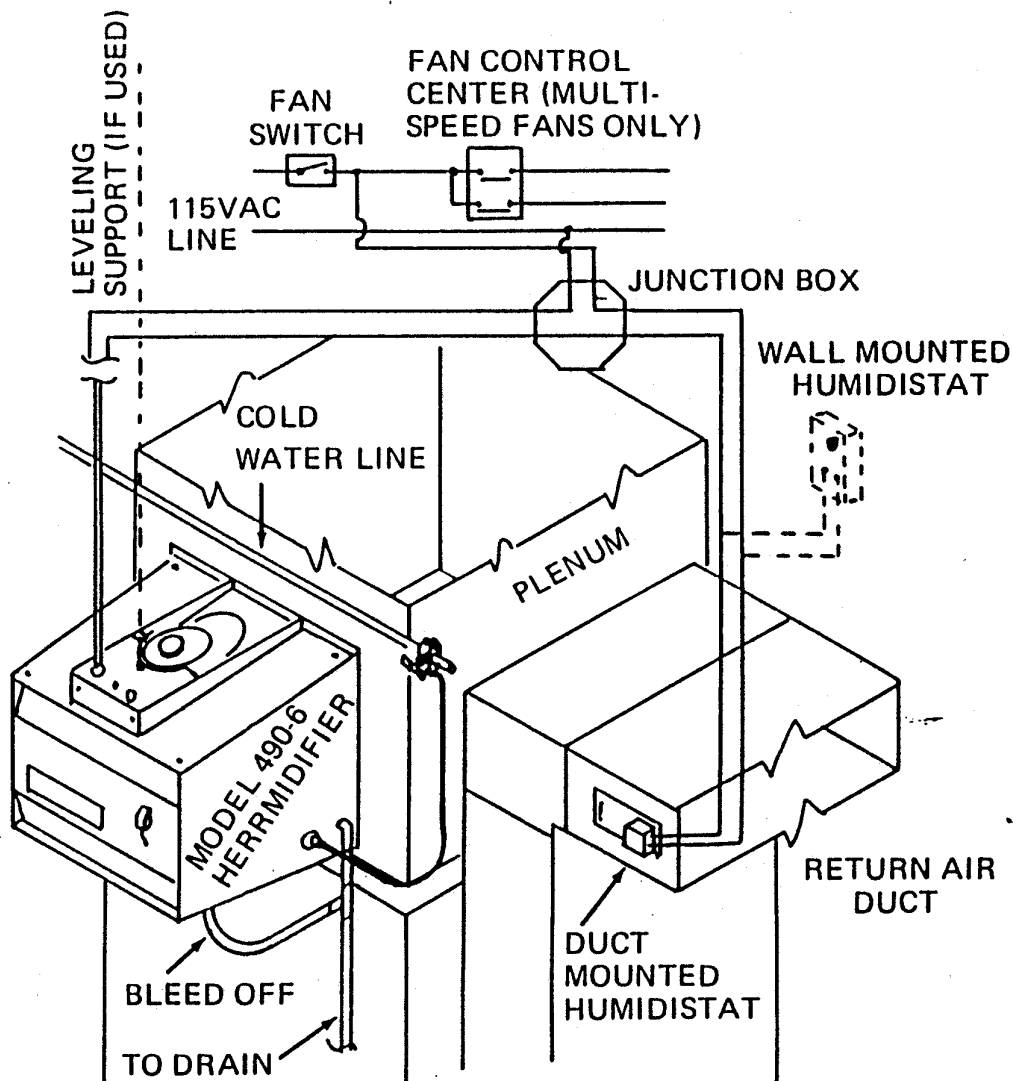

WIRING DIAGRAM FOR MODEL 490-6
USING DUCT OR WALL MOUNTED HUMIDISTAT

NOTE: MOTOR ON HERRMIDIFIER SHOULD RUN ONLY
WHILE FURNACE FAN IS OPERATING

- Step 16. Using approved line voltage (110-120 V.) wiring, wire the humidifier, humidistat, and furnace controls as shown on the wiring diagram above. The humidifier must be wired so that it can run only when the furnace fan is operating.
- Step 17. Turn on electrical current. Adjust controls so that furnace fan and unit operate. Check operation of humidistat while furnace fan is running. This can be done by changing the setting of the level of relative humidity to be sure humidistat is operating properly with furnace fan running. With HERRmidifier running, adjust controls so that furnace fan cuts-off. Humidifier should also stop operating.

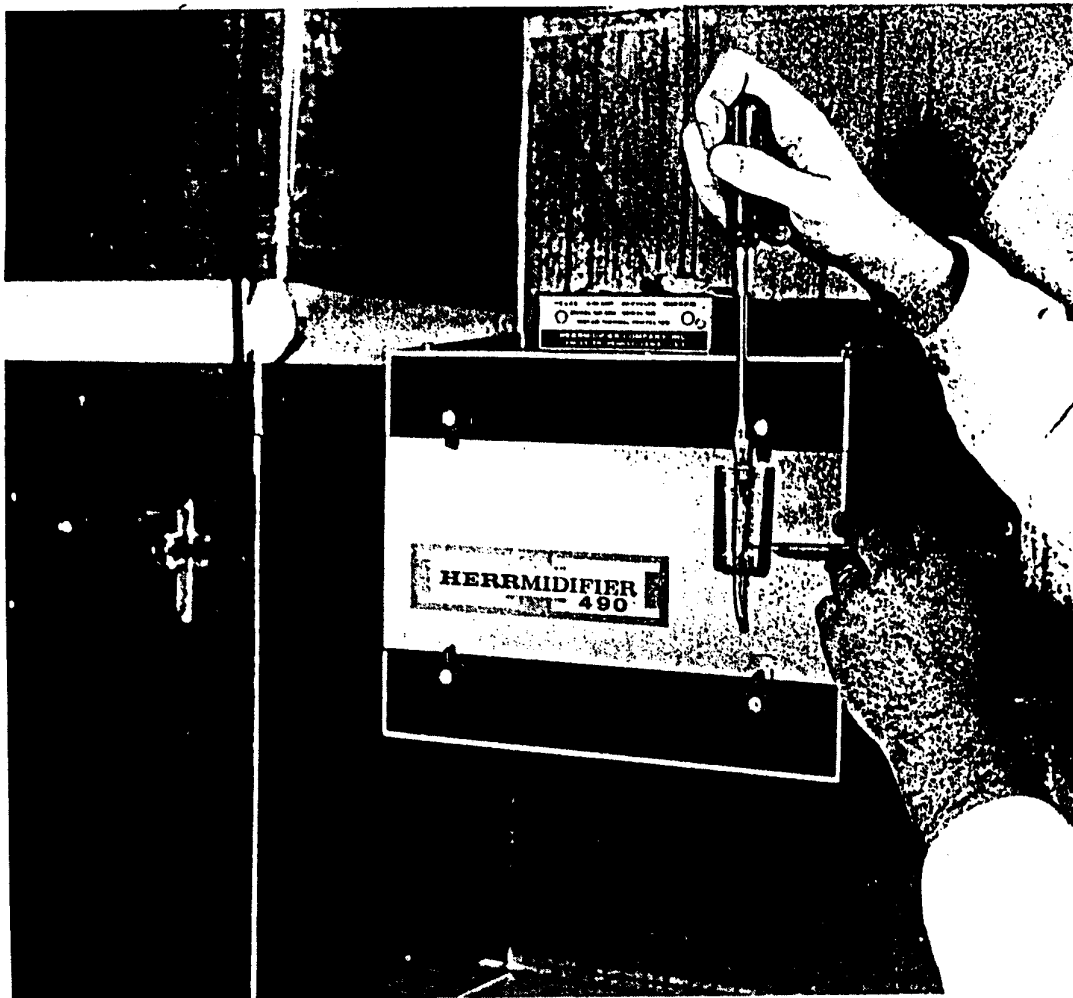

Step 18. Adjust filter gauge to conditions of the system. With system operating, adjust filter gauge so that the ball in the sight glass goes up to the "service" mark. This adjustment is made on the by-pass valve. Then, slowly turn this by-pass valve until the ball reaches the point of the bottom arrow on the sight glass. This adjustment is now complete. (When the filter needs cleaning, the ball will rise to the "service" arrow on the gauge.)

NOTE: If gauge does not adjust, turn slot on by-pass valve
1/2 turn

Step 19. Fill out warranty card and mail to HERRMIDIFIER. This card must be received to register the one year warranty.

Step 20. Keep this manual with the HERRMIDIFIER or turn it over to the owner.

Step 21. Instruct the owner in operation and maintenance.

OPERATION

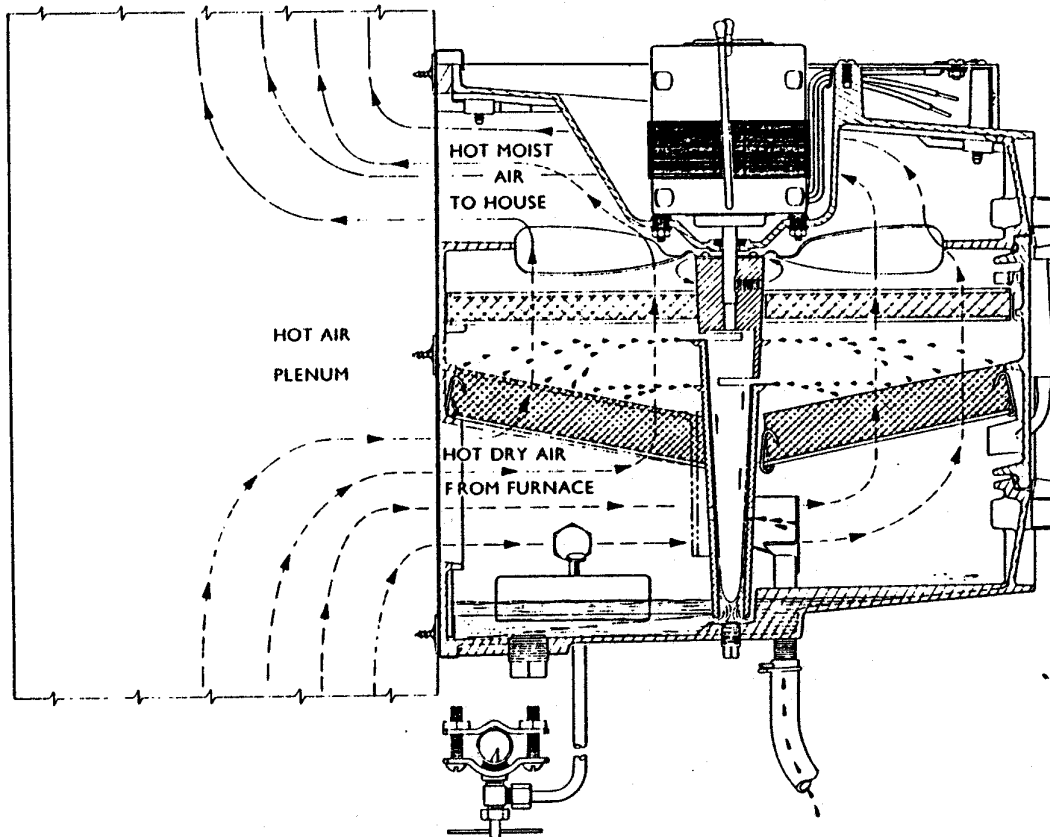

The Model 490-6 operates quietly, efficiently and entirely automatically. In addition to assuring greater comfort in the home, the Model 490-6 is economical to operate. In fact, this unit consumes less current than a 75 watt lamp bulb.

In the Model 490-6, the evaporative pad is in a horizontal position. It is totally saturated from above with no dead spots or partially covered areas. The warm air is forced upward through the pad where it is uniformly humidified. This design makes the Model 490-6 the most efficient plenum type humidifier on the market with greater output than any other.

The bleed-off drain removes mineral deposits each time the unit runs. These deposits are left when water evaporates to humidify air. The deposits are flushed down the bleed-off drain. Only one gallon of water is flushed down the drain for each hour the HERRMIDIFIER 490-6 operates.

We are most anxious to help you enjoy the benefits of living in a properly humidified atmosphere. Address inquires to the service department at the factory.

For maximum efficiency and greater economy in operating the Model 490-6, follow the four steps listed below.

- Step 1. Set humidistat at desired level. We recommend 40-50%. The HERRMIDIFIER (if properly installed and wired) can only run when the furnace fan is running.
- Step 2. The humidistat setting can be adjusted as desired.
- Step 3. To prevent condensation on single pane windows, the level of relative humidity can be lowered as needed.
- Step 4. When the ball in the filter gauge is up to the "service" level, the evaporative pad needs cleaning. The frequency of cleaning required depends on the hardness of the water used in the unit. We suggest you look at the gauge once a week during the heating season and clean as required (see Maintenance). Use of bleed-off drain reduces frequency of cleaning required (see step 10, page 7).

MAINTENANCE

WARNING: Periodic cleaning is required for efficient and safe operation of this humidifier (See Instructions below)

The Model 490-6 HERRMIDIFIER is constructed of the highest quality corrosion resistant materials to assure superior performance. The rugged construction and extremely simplified design of the Model 490-6 assures maximum efficiency with an absolute minimum of maintenance.

Exclusive with the Model 490-6 is the visual filter gauge. This clear plastic gauge shows at a glance when the evaporative pad should be removed and cleaned.

Use of a drawer type evaporative pad provides an easier method of cleaning and changing both the evaporative pad and filter pad — a process so simple that it can be done in a few minutes.

Simple to install, economical to operate, the Model 490-6 is easy to maintain. Occasional cleaning is all that is normally required for low-cost, trouble-free performance, provided the bleed-off drain is used.

- Step 1. Tap gauge lightly to be sure ball is not stuck. If the filter gauge indicates "service" is needed, the evaporative pad should be removed and cleaned. At the same time, inspect filter pad and clean as required. The procedure for the filter pad is the same.

Procedure:

- a. Turn humidistat to lowest setting and adjust thermostat low enough to prevent furnace from starting during removal of the filter.



All latches rotate counterclockwise to loosen door. (See step 13, P-8)

- b. Swing (4) latches holding door of unit away from door and remove the door.

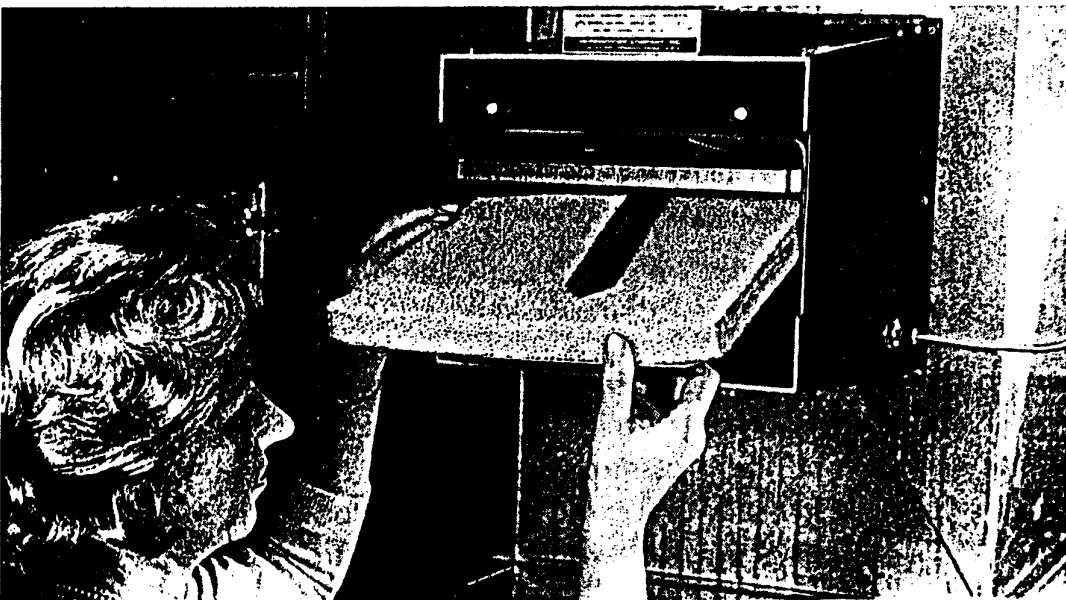

- c. Pull out evaporator cage carefully.

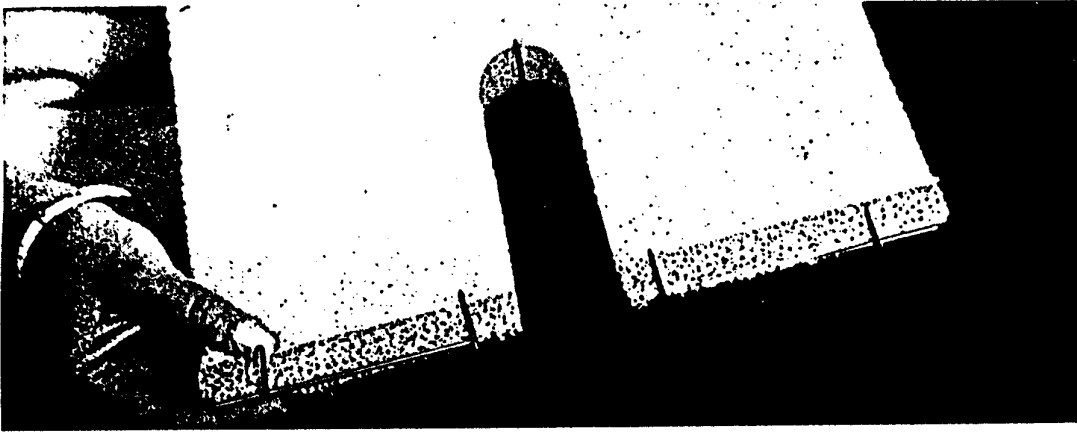

- d. Detach the pad from the 7 rings holding it to wire cage.
- *e. If you have a spare pad, install pad on cage and replace rings.
NOTE: Rings should be placed in about the same position as shown. Pad should be supported by cage on all edges.
- * If spare evaporative pad is not available, door can be put back into position and furnace run without pad. However, leave humidistat at the lowest setting so that humidifier does NOT operate while pad is out being cleaned.



- f. Slide evaporator pad back into case on lower tracks provided on the sides of the case. (Filter pad at top should be on top tracks.)
- g. Rotate fan and pump assembly by hand to be sure it turns freely.
- h. Clean door, case, and door gasket to insure good seal. Replace door of case and turn 4 latches to secure it in position. All latches rotate clockwise to tighten door. (See step 13, P-8)
- i. Turn humidistat and thermostat back to desired level and unit will operate again automatically.

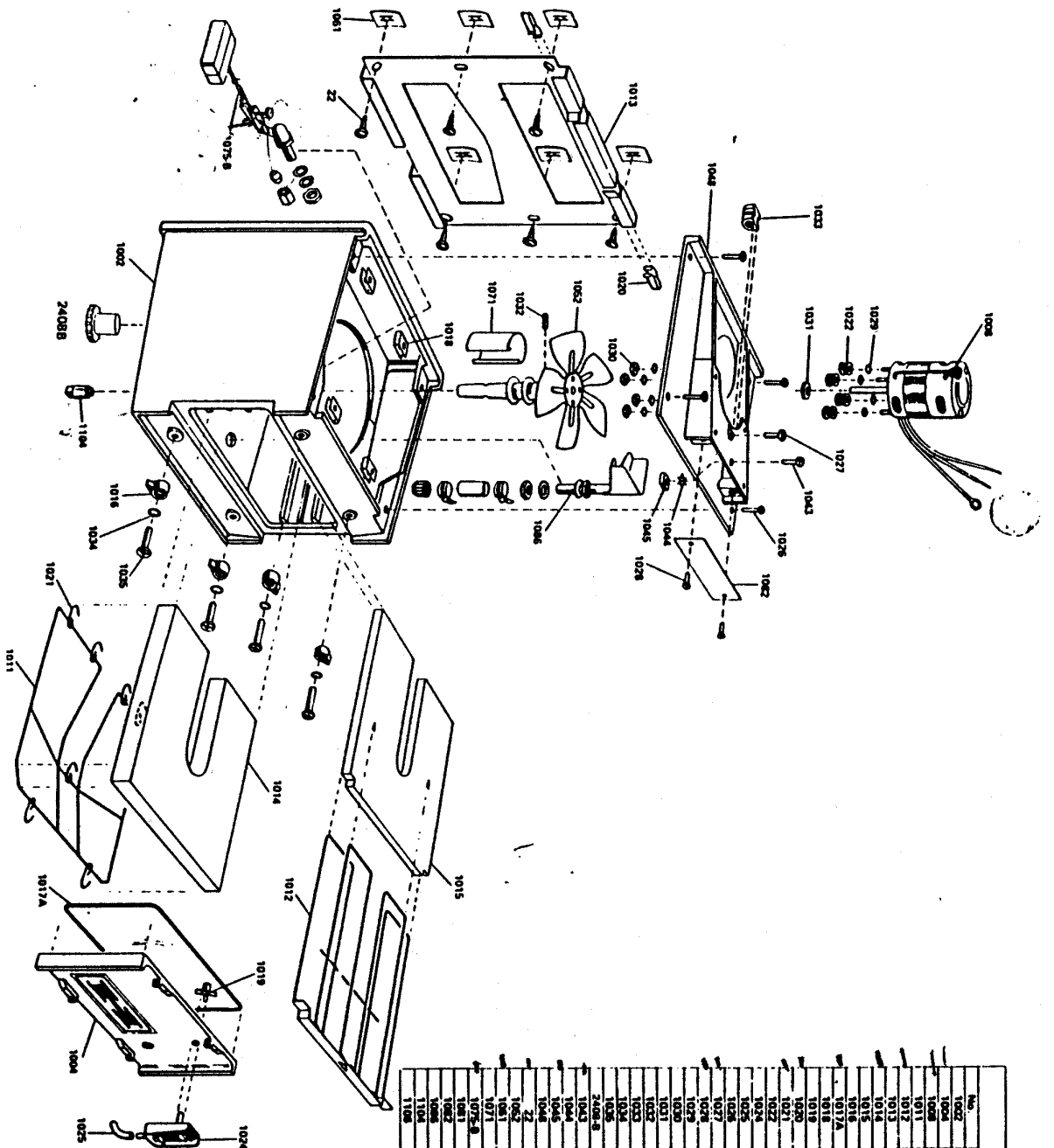

"490-6" PARTS LIST

No.	QUANTITY	NAME OF PART
1002	1	CASE & BACK ASSEMBLY
1004	1	DOOR
1006	1	MOTOR
1011	1	BOTTOM SUPPORT
1012	1	TOP SUPPORT
1013	1	MOVING PLATE
1014	1	GENERATION PAD
1015	1	LAYER PAD
1017A	1	GASKET
1018	1	UP RUIT
1019	1	COMPRESSOR RING
1020	2	SAFETY CLIP
1021	1	RING
1022	1	BUSHING
1024	1	GAUGE
1025	1	TUBE
1026	1	TOP SCREW
1027	1	CHAIN SCREW
1028	1	BOX COVER SCREW
1029	1	MOTION MOUNT WASHER
1030	1	MOTION MOUNT NUT
1031	1	FELT WASHER
1032	1	GRONOMET
1033	1	PUMP SET SCREW
1034	1	WAVE WASHER
1035	1	LATCH SCREW
1036	1	DRUM PLUG
2408-8	1	GROUND SCREW
1043	1	GROUND WASHER
1044	1	GROUND NUT
1045	2	TOP COVER ASSEMBLY (includes 1003)
22	1	SHEET METAL SCREW
1052	1	PUMP & PAN ASSEMBLY
1051	1	SHEET METAL SCREW NUT
1071	1	STAINLESS STEEL SHROUD
1072-8	1	FLOAT & VALVE ASSEMBLY
1081	1	DATA PLATE (see assembly)
1082	1	COVER SET CHAIR ASSEMBLY
1083	1	FIELD OUT (LUG)
1084	1	FIELD OUT (LUG)
1108	1	PUMP BRUSH (see drawing)

TO CLEAN PADS

Do NOT try to clean pads by breaking-off deposits.

Method 1. Use Herrmidifier Humidifier Cleaner (HHC-2) in accordance with directions on the bottle.

Method 2. Evaporator pad (and filter) can be cleaned easily by soaking it in 4 quarts of solution made up of half white distilled vinegar and half water for 4 to 6 hours using any container except one of aluminum or copper. Repeat with new solution if all of deposit has not been removed. Rinse thoroughly with clear water or wash out pad in washing machine. If vinegar odor persists, it can be removed with a solution of 4 tablespoons of baking soda in a quart of water.

TO CLEAN INSIDE OF CONE SHAPED PUMP

Remove small (1/8") clean out plug on bottom of case. Use bottle brush supplied with unit and cleaning solution to clean.

TO CLEAN INSIDE OF CASE

Turn System off. Remove pads. Turn off water at saddle valve. Use cleaning solution to coat scaled areas. Clean off deposits with cloth or brush. Use orange plug in bottom of case to drain and flush clean. Replace plug, turn on saddle valve, check water level (see Step 13), replace pads (filter pad holder is marked for "Up" position), replace door and start unit.

IMPORTANT: The amount of attention required for any humidifier increases with the degree of water hardness, especially if the bleed-off drain is not used.

Algae formations (brown or green slimy deposits) may occur with certain types of water and clog parts of the unit. Add a few drops of Clorox to the water in the unit weekly to prevent this formation. Use of bleed-off drain will reduce algae problems.

SUMMER OPERATION: Turn off water to Humidifier. If furnace fan is used for cooling, set Humidistat to lowest setting. This is a good time to clean the unit so it will be ready for use when the heating season starts. When heating season starts, turn on water to Humidifier. Remove door and check water level (see Step 13, page 8). Adjust float as required with thumb screw. Turn Humidistat to desired level.