



The Care Free[®] Ultra Evaporative Humidifier



Model 34257

www.hunterfan.com

ENGLISH
See page 2

ESPAÑOL
Vea la página 15

READ AND SAVE THESE INSTRUCTIONS

Important Safety Instructions: Read all instructions before using this humidifier.

CAUTION: To avoid electrical shock and/or fire, please read all instructions before use.

Thank you for purchasing the Care Free® Ultra Evaporative Humidifier by Hunter Fan Company. Please read and save these instructions to receive maximum benefit and performance from your humidifier.

1. This humidifier may not work properly on an uneven surface. **ALWAYS** place this humidifier on a firm, level and water resistant surface. **ALWAYS** place the humidifier at least six (6) inches away from walls and heat sources such as stoves, radiators or heaters.
2. **ALWAYS** place the humidifier in an area that is out of the reach of children.
3. Before using the humidifier, extend the cord and inspect for any sign of damage. **DO NOT** use the product if the cord has been damaged.
4. This product has a polarized plug as a safety feature (one blade is wider than the other). This plug will fit into a polarized outlet only one way. If the plug does not fully fit into the outlet, reverse the plug. If it still does not fit, contact a qualified electrician. **DO NOT** attempt to defeat or override this feature.
5. **ALWAYS** unplug and empty the humidifier when it is not in operation or while it is being cleaned.
6. **DO NOT** tilt or move the humidifier while it is in operation. Never move the humidifier while there is water in the tank. Empty the water tank, turn the unit off, and unplug the unit before moving.
7. In addition to routine maintenance which may be required, this humidifier requires seasonal cleaning. Refer to and follow the instructions for **CLEANING THE HUMIDIFIER AND THE WATER TANK**.
8. This unit was designed to be used with distilled and/or tap water. **DO NOT** add scented oils, perfumes or fragrance additives to the water.

How the Care Free® Ultra Evaporative Humidifier Works

The Care Free® Ultra Evaporative Humidifier has a unique, patented design with several innovative features:

- **Wickless Humidifier** – Hunter's exclusive system does not require a wick to create humidity. Water is transported up the tube and is dispersed by centrifugal force against the Atomizer. The tiny water particles created from this impact are then evaporated by the oncoming air stream and the moist air is released through the exhaust vents beneath the Water Tank.
- **Simple Pump System** – By dispersing water via centrifugal force through openings in the funnel pump, stagnant water in the reservoir is eliminated and the buildup of mineral residue that can clog conventional pump systems and impede performance is eliminated.
- **Built-In Antimicrobial Properties** – The plastic parts in this humidifier and the filter have built-in antimicrobial properties to inhibit the growth of bacteria, mold and fungi that may affect these parts.

NOTE: The antimicrobial properties built into this humidifier do not extend to the water, humidified air or users. Conduct routine cleaning and maintenance based upon use and individual conditions.

- **No White Dust** – The Care Free® Ultra Evaporative Humidifier produces no white dust that can settle on furniture or be inhaled.

NOTE: You may notice mineral deposits accumulating in the tank base or on other components. This is normal and comes with regular usage conditions. If you would like to remove these deposits and maintain humidifier performance, please see the section **CLEANING THE HUMIDIFIER AND THE WATER TANK.**

Assembly of Humidifier Parts

ATTENTION: Before operating the unit, remove the tape strips located on the bottom of the power pack. These tape strips are used to secure the pump components during shipment and should be removed prior to operation. See Figure 1.

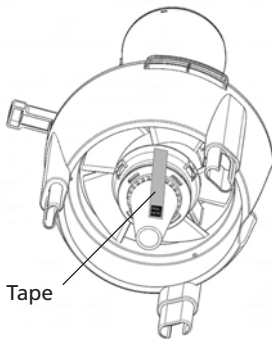

Figure 1

1. Remove the Care Free® Ultra Evaporative Humidifier from its packaging.
2. Select a location for your humidifier. The location should be flat, hard, water-resistant and at least six (6) inches away from walls and sources of heat.

HUNTER WILL NOT ACCEPT RESPONSIBILITY FOR DAMAGE DUE TO WATER SPILLAGE.

3. Remove the Lower Reservoir (marked with the number 2) from the Water Tank and Upper Reservoir (marked with the number 1). See Figure 3.

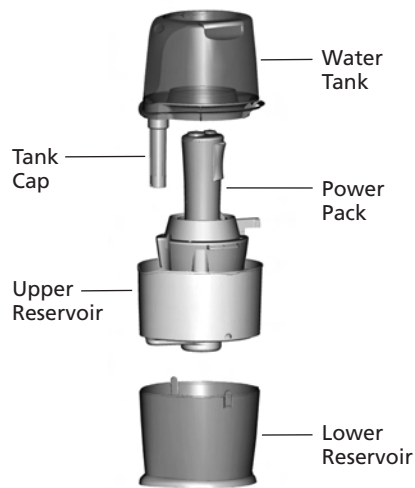

Figure 2

4. Set the Lower Reservoir on the flat, hard surface you have chosen.

NOTE: Once the unit has been filled with water and is operating, you should not use the Upper Reservoir handles or Water Tank handles to pick up and relocate the humidifier without emptying all water from the humidifier. Prior to moving the humidifier, check the water window in the Lower Reservoir for water. If there is water in the Lower reservoir, remove the Water Tank and Upper Reservoir and drain all water.

continued

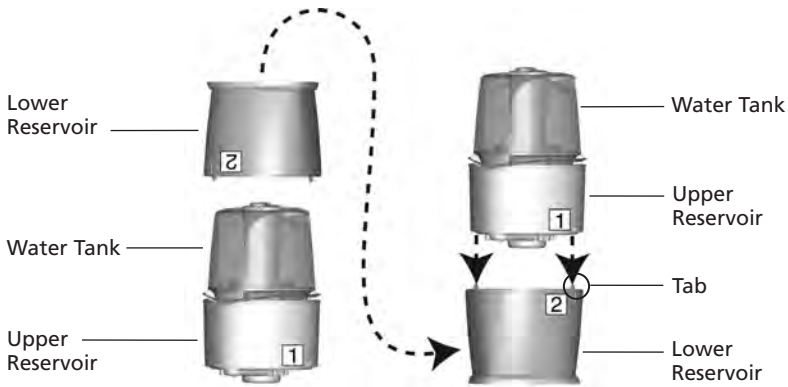

Figure 3

5. Lift the Upper Reservoir (marked with the number 1) and Water Tank and place them on top of the Lower Reservoir (marked with the number 2) so that the two tabs in the Lower Reservoir snap into the Upper Reservoir. See Figure 3.

6. Take the Water Tank to a sink or tub to fill with water.

7. Unscrew the Tank Cap by twisting it counterclockwise and fill the Water Tank with cool water. **NEVER USE HOT WATER.** See Figure 4.

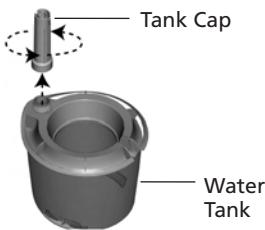

Figure 4

8. Replace the Tank Cap by screwing it back onto the Water Tank clockwise. Securely tighten the Tank Cap and make sure it is properly sealed. See Figure 5.

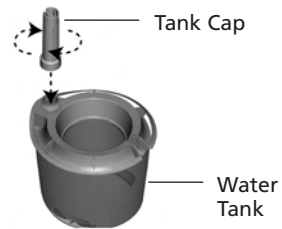

Figure 5

9. Carrying the Water Tank by the two upper handles on the top of the Tank, position the Water Tank so that the notch in the back fits over the power supply cord and the Tank Cap in front fits into the cut-out area of the Power Pack. See Figure 6.

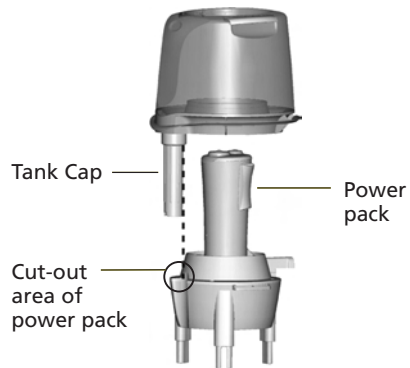

Figure 6

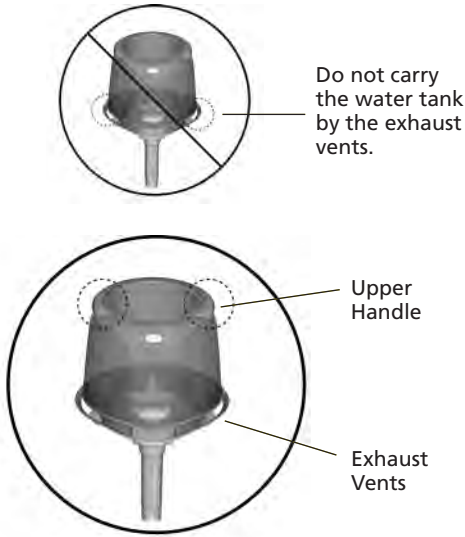

Figure 7

NOTE: Do not carry the Water Tank by the exhaust vents. See Figure 7.

10. If the Water Tank is properly seated, you will see air bubbles flowing up into the tank. If you do not see air bubbles, reposition the Water Tank as instructed above. Make sure the Power Knob is set to OFF and plug the humidifier into the wall outlet.

CAUTION: Never plug in the humidifier while your hands are wet, as electric shock could occur.

11. Thread the power cord through both power cord clips on the back of the humidifier.
12. Turn the Power Knob to the desired setting.

NOTE: If the Water Tank is not seated properly on the Power Pack, it will not turn on.

Operating Your Humidifier

Humidifier Controls

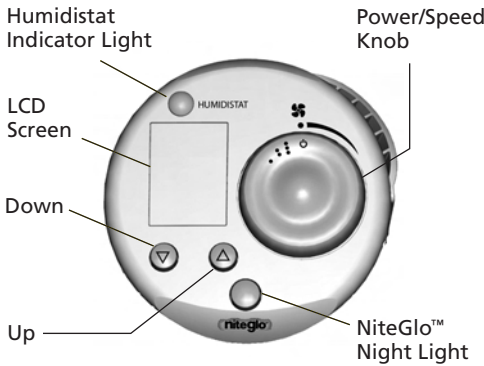

Figure 8

1. **Power/Speed Control:** Turns the humidifier ON and OFF. The power should always be OFF before unplugging the humidifier, moving the humidifier, or refilling the water tank. See Figure 8.

Turn the dial to set the speed to High, Medium, Low and Off. See figure 9.

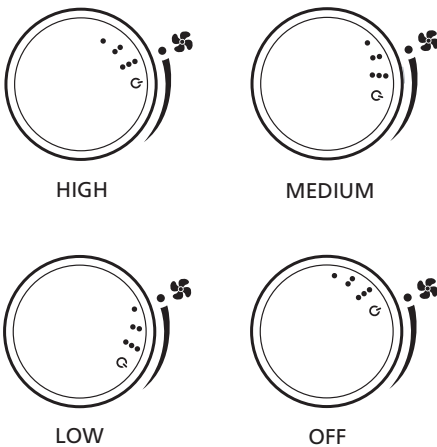

Figure 9

2. **Humidistat Display and Controls:** Enables you to set desired maximum humidity level. Once this level is exceeded, the unit will shut off until the humidity level drops.

NOTE: The humidifier may not be running because the humidistat setting may need to be adjusted.

3. **Humidistat Light:** The green light will go off when the humidity in the room exceeds the level that you selected with the digital humidistat.
4. **NiteGlo™ Night Light Control:** Turns the night light 'ON' and 'OFF'. The night light can be turned on even if the humidifier fan is turned OFF.

Setting the Desired Humidity

NOTE: After unplugging the humidifier to move the humidifier, to refill the water tank or to clean the humidifier, you must reset the digital humidistat.

1. Use the power/speed control knob to turn the humidifier ON by selecting a speed setting.

NOTE: A speed setting must be chosen before the humidistat will operate the humidifier.

2. In normal mode use the humidistat control buttons to set the desired humidity level. The settings range from 30% to 80% in 5% increments.
3. When the humidity exceeds the level you have set, the humidistat light will go off. The humidifier will not output humidity while the humidity in the room is at the selected humidity level. The humidistat light will stay off until the humidity changes. When the humidity in the room drops below the selected level, the humidifier will cycle on again and the humidistat light will come on.

Setting the Span

Your humidistat is set at the factory to cycle at setting 2. If you find your system cycling too fast or too slow, then the Span can be adjusted to modify the cycle time.

1. Press and hold both humidistat control buttons for two seconds to enter Span setting mode.
2. In Span mode, use the humidistat control buttons to adjust the Span. Raise the Span

to 3 to increase the cycle time and allow your system to run longer. Lower the Span to 1 to decrease the cycle time and allow your system to run shorter.

3. The humidistat display will return to normal mode after keys are idle for 5 seconds.

Refilling The Water Tank

1. When the water level is low, turn the Power Knob to OFF and unplug the humidifier.
2. Lift the Water Tank and take it to the sink or a tub to refill.

NOTE: Do not carry the Water Tank by the exhaust vents.

3. Turn the Water Tank over and unscrew the Tank Cap by twisting it counterclockwise. See Figure 10.

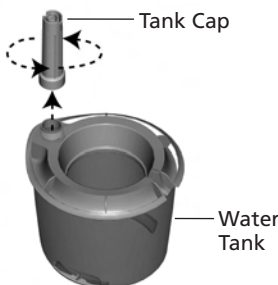

Figure 10

4. Empty the Water Tank and refill it with fresh, cool water. **NEVER USE HOT WATER.**
5. Replace the Tank Cap by screwing it clockwise onto the Water Tank. See Figure 11.

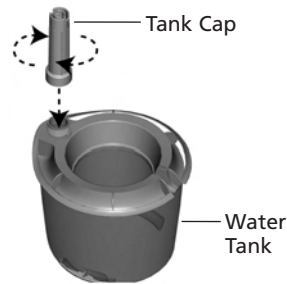

Figure 11

6. Carrying the Water Tank by the two upper handles on the top of the Tank, position the Water Tank so that the notch in the back fits over the power supply cord and the Tank Cap in front fits into the cut-out area of the Power Pack. If the Water Tank is properly seated, you will see air bubbles flowing up into the tank. If you do not see air bubbles, reposition the Water Tank as instructed above.

CAUTION: Never plug in the humidifier while your hands are wet, as electric shock could occur.

7. Make sure the Power Knob is set to OFF and plug the humidifier into the wall outlet.
8. Turn the Power Knob to the desired setting.

Cleaning the Humidifier and the Water Tank

Many regions have hard water with high concentrations of minerals. When water evaporates from the Care Free® Ultra Evaporative Humidifier, minerals may be left behind. These minerals can form a hard white scale which can be removed by following the cleaning instructions. The frequency of cleaning due to mineral build-up varies depending on the quality of water you have.

1. Turn the Power Knob to OFF and unplug the humidifier.
2. Remove the Water Tank and carry it to a sink or a tub. Unscrew the Tank Cap by twisting it counterclockwise and empty any water in the Water Tank.
3. Lift the Power Pack and locate the three tabs on the top of the Funnel Pump Assembly. Press the three tabs in and remove the Funnel Pump by pulling away from the underside of the fan blade.
4. Remove the Pump Cap from the Funnel Pump by holding the Pump Cap securely in one hand while twisting the Funnel Pump in a clockwise direction. This will unlock the two components. See Figures 12a and 12b.

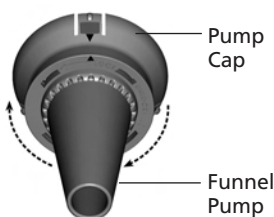

Figure 12a

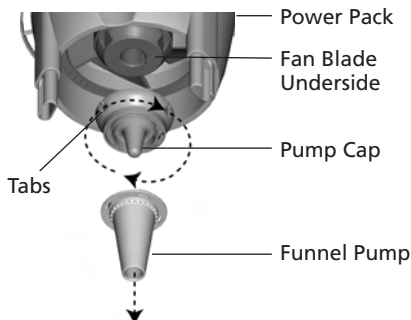

Figure 12b

5. Remove the Atomizer and the Upper Reservoir. See Figure 13.

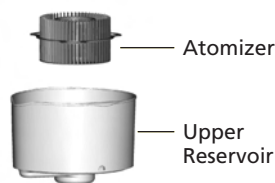

Figure 13

6. Soak the Upper Reservoir, Funnel Pump, Pump Cap, and Atomizer in a solution of one (1) gallon of water and eight (8) ounces of vinegar for 30 minutes.

NOTE: If the Atomizer is covered with hard white scale, you may want to run this component through the dishwasher to loosen the scale before soaking.

The Atomizer is the only dishwasher-safe component and may be placed in the top rack only.

7. To clean the Water Tank, fill the tank with one (1) gallon of water and eight (8) ounces of vinegar. Replace the Tank Cap tightly and shake the Water Tank vigorously until all interior surfaces have been exposed to the solution.
8. Rinse the Water Tank several times with cool, clean water.
9. After soaking, rinse the components with clean water several times. Use a soft cloth or sponge to remove any build-up. Allow the components to dry completely if you plan to store the humidifier.
10. To clean the surfaces of the Power Pack, wipe with a dry, soft cloth.

Reassembly of Humidifier Parts

1. Set the Lower Reservoir on the flat, hard surface you have chosen.
2. Attach the Upper Reservoir to the Lower Reservoir by engaging the two tabs on the sides. See Figure 14.

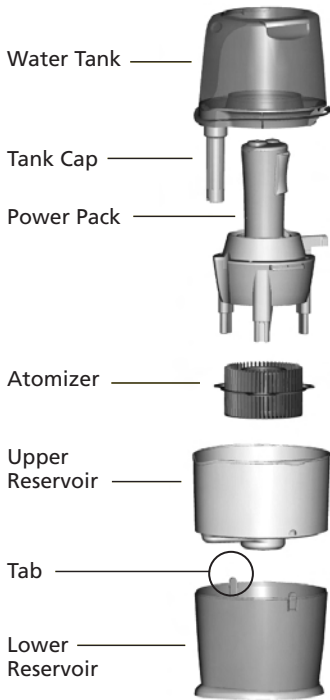

Figure 14

3. Place the Atomizer in the Upper Reservoir, aligning the three oval holes in the Atomizer with the three prongs in the Upper Reservoir. The side of the Atomizer with three short posts should be facing upward. See Figure 15.

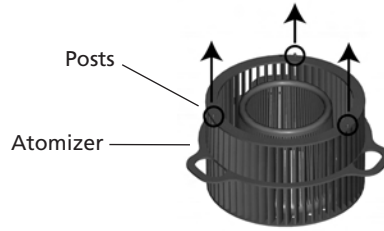

Figure 15

4. Assemble the Pump Cap and the Funnel Pump by aligning the arrows on both components and inserting the Funnel Pump into the Pump Cap. Twist the Funnel Pump counter-clockwise until the two components snap together. See figures 16a and 16b.

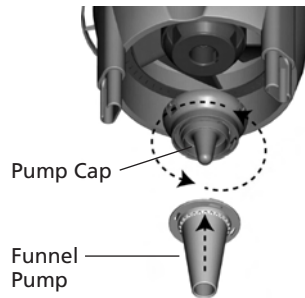

Figure 16a

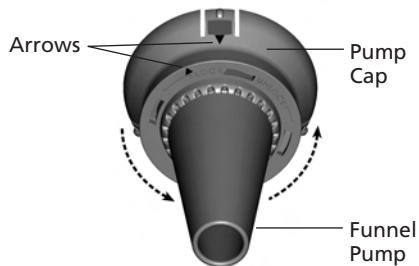

Figure 16b

continued

ENGLISH

5. Attach the Funnel Pump Assembly to the Power Pack by engaging the three tabs on the underside of the fan blade. See Figure 17.

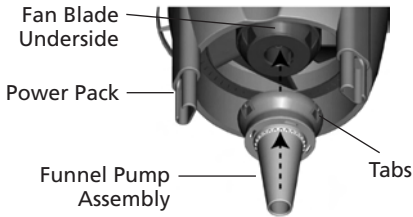

Figure 17

6. Place the Power Pack into the Upper Reservoir so that the three prongs in the Power Pack go through all three holes in the Atomizer and into the three prongs in the base of the Upper Reservoir. Make sure the Power Pack is securely seated and all three prongs are in the proper position. See Figure 18.

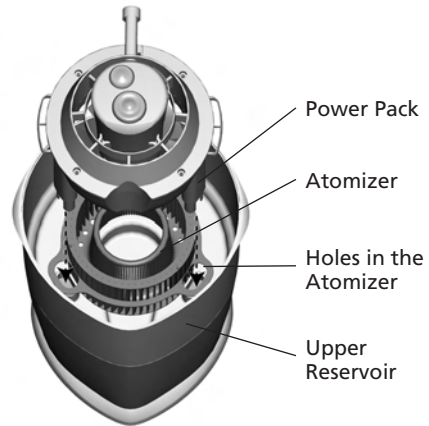

Figure 18

NOTE: The prongs will only fit into the Upper Reservoir one way.

7. Follow the directions in the section **REFILLING THE WATER TANK** to complete reassembly.

Relocating the Humidifier

If you wish to move your humidifier to a different location, follow the instructions as listed below.

DO NOT attempt to carry the humidifier when there is water in the Upper Reservoir, Lower Reservoir, or the Water Tank.

1. Turn the Power Knob to OFF and unplug the humidifier.
2. Remove the Water Tank from the Upper Reservoir and drain all water.
3. Remove the Upper Reservoir from the Lower Reservoir and drain all water.
4. If there is water in the Lower Reservoir, drain all water.
5. Set the Lower Reservoir on the hard, flat surface you have chosen.
6. Continue assembly as outlined in the section **REASSEMBLY OF HUMIDIFIER PARTS**.

Troubleshooting

Problem:

Excessive noise.

Solution:

1. Check the Water Tank to make sure it is properly seated on the Power Pack.
2. Check the Water Tank to make sure there are no bubbles when the Water Tank is full and running. If there are bubbles, turn the unit OFF until the bubbling stops. When the bubbling has stopped, set the unit to the desired speed.
3. Remove and clean the Pump Cap and Funnel Pump. Refer to the section on **CLEANING THE HUMIDIFIER AND THE WATER TANK.**

2. Make sure the Water Tank is properly seated on the Power Pack.
3. Check the humidity levels on the display. If the ambient room humidity is equal to or higher than the set level, the unit will not turn on.

Problem:

Humidifier not working.

Solution:

1. Make sure the Power Knob is not set to OFF.
2. Adjust the humidity level using the Power Knob and the Humidistat Controls. Once the room reaches the set humidity level, the humidifier will turn OFF; this is normal.
3. Make sure the Power Pack and Water Tank are both fully seated in the three tabs on the Upper Reservoir.
4. Make sure the Atomizer is facing the proper direction.

Problem:

Mineral build-up on the Water Tank or Upper Reservoir.

Solution:

1. Refer to the section on **CLEANING THE HUMIDIFIER AND THE WATER TANK.**

Problem:

Humidity output and water usage decreased.

Solution:

1. Make sure the Atomizer is positioned correctly, with the side with three posts facing upward.
2. Check the Humidistat Setting and Power Knob to make sure they are set to the desired humidity level.
3. Check the Water Tank to make sure there are no bubbles when the Water Tank is full and running. If there are bubbles, turn the unit OFF until the bubbling stops. When the bubbling has stopped, set the unit to the desired speed.
4. Clean any components that have mineral build-up. Refer to the section on **CLEANING THE HUMIDIFIER AND THE WATER TANK.**

Problem:

Humidifier will not turn on.

Solution:

1. Check the three posts on the top surface of the Atomizer are properly engaged. The side of the Atomizer with three short posts should be facing upward.

continued

Problem:

Excessive water drainage into lower reservoir.

If you have questions or problems, please call 1-888-830-1326 for assistance before returning the unit to the retailer.

Solution:

1. Make sure the Tank Cap on the Water Tank is tightened sufficiently and properly sealed.

Service Parts

To obtain a service part for your humidifier, call Hunter Customer Service at 1-888-830-1326 or e-mail us at Techsupport@hunterfan.com. Please be prepared to tell the operator the model number of your humidifier, the name of the part you need to replace, and the part number.

Model No.	Atomizer	Funnel Pump	Pump Cap	Power Knob	Tank Cap	Water Tank
34257	96146-01-509	96150-01-509	96149-01-509	86592-02-509	96334-01-509	96333-01-326

Hunter Fan Company

The Care Free® Ultra Evaporative Humidifier

5 YEAR LIMITED WARRANTY

Hunter Fan Company, Inc. makes the following warranty to the original residential user or consumer purchaser of the Care Free® Ultra Evaporative Humidifier.

If any part of the Care Free® Ultra Evaporative Humidifier ("Humidifier") motor fails during the first five (5) years from the date of installation due to a defect in material or workmanship, we will provide a replacement part free of charge. If no replacement part can be provided for such motor, we will replace your humidifier.

If your humidifier motor fails anytime within one (1) year after the date of installation due to a defect in material or workmanship, labor to repair the defect will be provided free of charge at our nearest service center or at our Service Department in Memphis, Tennessee. You will be responsible for all parts and labor costs after this one year period.

If your humidifier water tank, atomizer, base, knobs or tank cap fail at any time within one (1) year after the date of sale to you due to a defect in material or workmanship, we will repair, or at our option, replace the water tank, atomizer, base, knobs or tank cap free of charge for parts or labor at our nearest service center or at our Service Department in Memphis, Tennessee.

IF THE ORIGINAL RESIDENTIAL USER OF CONSUMER PURCHASER CEASES TO OWN THE HUMIDIFIER, THIS WARRANTY AND ANY IMPLIED WARRANTY WHICH THEN REMAINS IN EFFECT, INCLUDING BUT NOT LIMITED TO IMPLIED WARRANTY OF MERCHANTABILITY OR FITNESS FOR A PARTICULAR PURPOSE, ARE VOIDED.

NO WARRANTY, EXPRESSED OR IMPLIED, INCLUDING ANY WARRANTY OF MERCHANT-

ABILITY OR FITNESS FOR A PARTICULAR PURPOSE, IS MADE IN RESPECT TO THE FILTER.

THE WARRANTY IS IN LIEU OF ALL OTHER EXPRESS WARRANTIES. THE DURATION OF ANY IMPLIED WARRANTY, INCLUDING BUT NOT LIMITED TO ANY IMPLIED WARRANTY OF MERCHANTABILITY OR FITNESS FOR A PARTICULAR PURPOSE, IN RESPECT TO THE MOTOR IS EXPRESSLY LIMITED TO THE PERIOD OF THE EXPRESS WARRANTY SET FORTH ABOVE.

This warranty is voided if your humidifier is not purchased and used in the USA or Canada.

This warranty excludes and does not cover defects, malfunctions or failures which were caused by repairs by persons not authorized by Hunter Fan Company, or accessories not authorized by Hunter Fan Company, mishandling, modifications, or damage to the humidifier while in your possession, or unreasonable use, including failure to provide reasonable and necessary maintenance. This warranty does not cover humidifiers used in commercial applications. There are not express or implied warranties as to commercial purchasers or users.

To obtain service, contact the nearest Hunter authorized service center or the Hunter Fan Company Service Department at 2500 Frisco Avenue, Memphis, Tennessee, 38114 or at (901) 248-2222. You will be responsible for insurance and freight or other transportation to our factory service center. We will return the humidifier, freight prepaid, to you. The humidifier should be properly packaged to avoid damage in transit since we will not be responsible for any such damage. Proof of purchase is required when requesting warranty service. The purchaser must present the sales receipt or other documentation that establishes proof of purchase.

continued

IN NO EVENT SHALL HUNTER FAN COMPANY BE LIABLE FOR DIRECT, INDIRECT, SPECIAL, CONSEQUENTIAL OR INCIDENTAL DAMAGES IN EXCESS OF THE PURCHASE PRICE OF THE HUMIDIFIER. YOUR SOLE REMEDY WILL BE REPAIR OR REPLACEMENT AS PROVIDED ABOVE.

SOME AMERICAN STATES AND CANADIAN PROVINCES DO NOT ALLOW:

- LIMITATIONS ON HOW LONG AN IMPLIED WARRANTY LASTS
- THE EXCLUSION OR LIMITATION OF DIRECT, INDIRECT, SPECIAL, INCIDENTAL OR CONSEQUENTIAL DAMAGES
- THE EXCLUSION OR INVALIDITY OF EXPRESS OR IMPLIED WARRANTIES IF THE USER CEASES TO OWN THE HUMIDIFIER

- THE LIMITATION OF REMEDIES AND RE-COURSES AVAILABLE TO THE PURCHASER, OR
- THE INVALIDITY OF AN EXPRESS WARRANTY WHEN A PRODUCT IS IDENTIFIED BY BRAND NAME IS NOT USED (UNLESS SPECIFIC CONDITIONS ARE FULFILLED)

SO THE ABOVE LIMITATIONS OR EXCLUSIONS MAY NOT APPLY TO YOU.

THIS WARRANTY GIVES YOU SPECIFIC LEGAL RIGHTS AND YOU MAY ALSO HAVE OTHER RIGHTS WHICH VARY FROM STATE TO STATE OR PROVINCE TO PROVINCE.

Other Home Comfort Products from Hunter

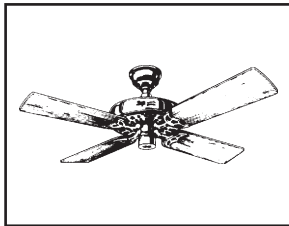

Hunter Original®

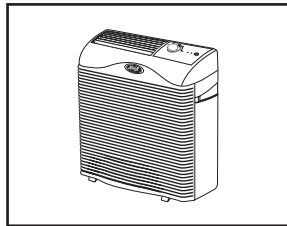

QuietFlo™
True HEPA Air
Purifier

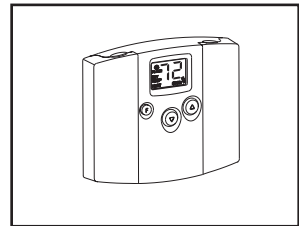

Programmable
Thermostat

To learn more about Hunter Fan Company products, please see our web page at:
www.hunterfan.com

HUNTER FAN COMPANY
2500 FRISCO AVENUE
MEMPHIS, TN 38114, USA

