

This Owner's Manual is provided and hosted by [Appliance Factory Parts](#).



# LG DPGT750EC1WW Owner's Manual

[Shop genuine replacement parts for LG  
DPGT750EC1WW](#)



[Find Your LG Dryer Parts - Select From 451 Models](#)

----- Manual continues below -----

## Table of Contents

Airflow Diagram (Gas and Electric Models) .....	
Backsplash .....	
Belt Switch .....	
Blower Motor .....	
Component Locator Views .....	
Control Features .....	
Door Switch .....	
Drive Belt .....	
Drive Motor .....	
Drum .....	
Drum Light .....	
Dryer Components .....	
Electronic Control Boards .....	
Front Panel .....	
Gas Valve .....	
Glo-Bar Igniter Circuit Operation .....	
Heater Assembly (Electric Models) .....	
Hi-Limit Thermostat .....	
Ignitor .....	
Inlet Thermistor .....	
Inverter .....	
Motor and Blower Wheel .....	
Nomenclature .....	
Outlet Thermostat .....	
Outlet Thermistor .....	
Reversing the Door Swing .....	
Safety Thermostat .....	
Service Diagnostics Program .....	
Schematic .....	
Sensor Rod Circuit .....	
Switching the Washer and Dryer Backsplashes .....	
Serial Number .....	
Top Panel .....	
Troubleshooting .....	
Troubleshooting Guide .....	
Warranty .....	

# Nomenclature

D P G T 7 5 0 E C 0 W W

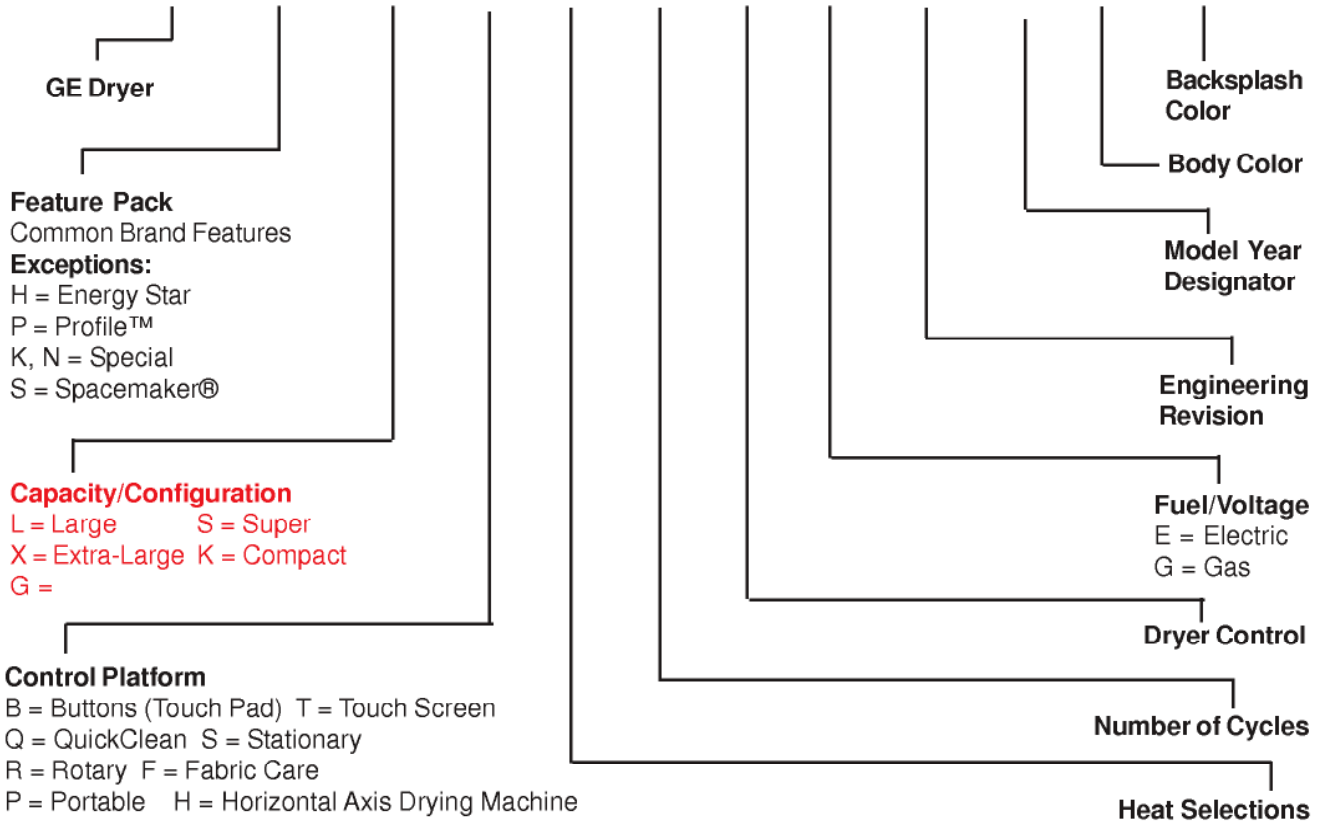

# Serial Number



**Note:** Model number and serial number are located on the front panel inside the door.

- The technical sheet is located behind the control panel.

The first two characters of the serial number identify the month and year of manufacture.

*Example:*    AD123456S = January 2003

A - JAN	2005 - H
D - FEB	2004 - G
F - MAR	2003 - F
G - APR	2002 - D
H - MAY	2001 - A
L - JUN	2000 - Z
M - JUL	1999 - V
R - AUG	1998 - T
S - SEP	1997 - S
T - OCT	1996 - R
V - NOV	1995 - M
Z - DEC	1994 - L

The letter designating the year repeats every 12 years.

*Example:*

T - 1974  
T - 1986  
T - 1998

# Warranty

All warranty service provided by our Factory Service Centers or an authorized Customer Care<sup>®</sup> technician. To schedule service on-line, 24 hours a day, visit us at [www.GEAppliances.com](http://www.GEAppliances.com) or call 800.GE.CARES (800.432.2737).

For The Period Of:	We Will Replace:
<b>One Year</b> <i>From the date of the original purchase</i>	<i>Any part</i> of the dryer which fails due to a defect in materials or workmanship. During this <b>full one-year warranty</b> , GE will also provide, <b>free of charge</b> , all labor and related service costs to replace the defective part.
<b>Second Year</b> <i>From the date of the original purchase</i>	<i>Any part</i> of the dryer which fails due to a defect in materials or workmanship. During this <b>additional one-year limited warranty</b> , you will be responsible for any labor or related service costs.
<b>Third through Fifth Year</b> <i>From the date of the original purchase</i>	<i>The extra large or super capacity dryer drum and main electronic control board</i> if any of these parts should fail due to a defect in materials or workmanship. During this <b>additional three-year limited warranty</b> , you will be responsible for any labor or related service costs.

## What Is Not Covered:

- Service trips to your home to teach you how to use the product.
- Improper installation.
- Failure of the product if it is abused, misused, or used for other than the intended purpose or used commercially.
- Replacement of house fuses or resetting of circuit breakers.
- Damage to the product caused by accident, fire, floods, or acts of God.
- Incidental or consequential damage caused by possible defects with this appliance.

*This warranty is extended to the original purchaser and any succeeding owner for products purchased for home use within the USA. In Alaska, the warranty excludes the cost of shipping or service calls to your home. Proof of the original purchase date is needed to obtain service under the warranty.*

*Some states do not allow the exclusion or limitation of incidental or consequential damages. This warranty gives you specific legal rights, and you may also have other rights which vary from state to state. To know what your legal rights are, consult your local or state consumer affairs office or your state's Attorney General.*

# Control Features

## Dryer Control Panel

Throughout this manual, features and appearance may vary from your model.

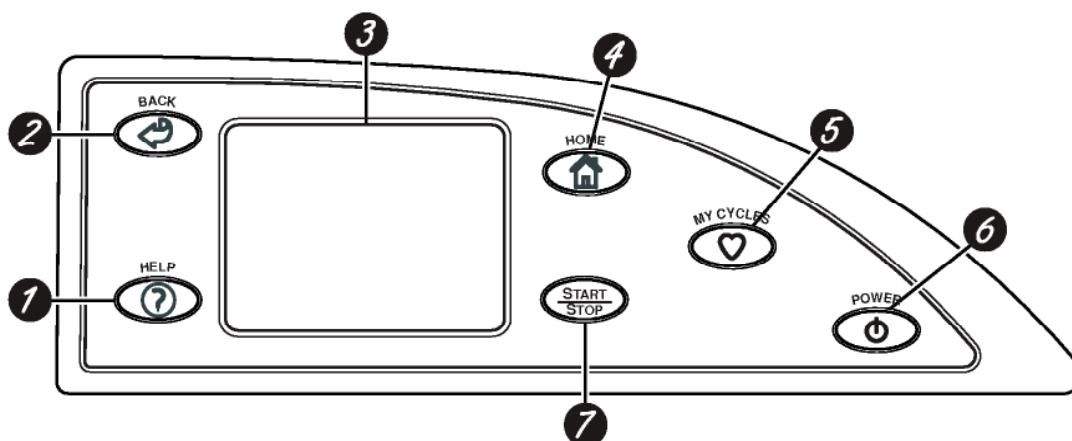

## Control Features

- 1 HELP.** Press to set machine preferences, to find help using the Touch Screen, or to find troubleshooting tips for common dryer problems.
- 2 BACK.** Press to return to the previous screen.
- 3 TOUCH SCREEN.** Press the touch pads on the interactive display to use the dryer features.
- 4 HOME.** Press to return to the "TOUCH TO SELECT Sensor DRY CYCLE" screen (Home Screen).
- 5 MY CYCLES.** Press to use, create, rename, modify, or delete custom dry cycles.
- 6 POWER.** Press to put the dryer into standby mode. Press the Touch Screen or any button to "wake up" the display.  
**NOTE: Pressing POWER does not disconnect the appliance from the power supply.**
- 7 START/STOP.** Press to start a dry cycle. If the dryer is running, pressing once will pause the dryer. Press again to restart the dry cycle.

## Quick Start

### Getting Started

If the Touch Screen is dark, press **POWER** to access the dry cycles menu.

- 1 Clean the lint filter.  
**IMPORTANT:** Clean the lint filter each time you use the dryer.
- 2 Add clothes. **Do not overload.** This wastes energy and promotes wrinkling.
- 3 Select one of the four drying methods from the Home Screen:
  - Press **BY FABRIC** to dry according to **fabric type**.
  - Press **BY GARMENT** to dry according to **clothing type**.
  - Press **SPECIAL CYCLES** to dry **non-garment items**, to dry without heat, or to dry using the drying rack.
  - Press **TIMED DRY** to specify a drying time and temperature.



Home Screen

- 4 Change any of the automatic settings, if desired, by pressing the Touch Screen pad and following the on-screen instructions.  
By changing the settings you can:
  - Change the level of dryness
  - Change the drying temperature
  - Set a Delay Start or Extended Tumble, or change the End-of-Cycle Signal volume
  - Adjust time settings

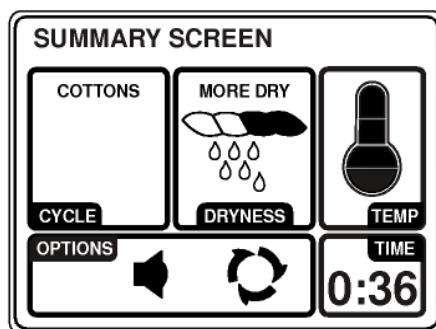

- 5 Close the door and press **START**.  
The dryer will not operate unless the door is closed.



### Washer Communicated Cycles

If the Washer/Dryer Communication features of your washer and dryer are turned ON, your dryer will receive cycle information from your washer once the wash cycle is complete.

Once the information is received, your dryer can then create the optimal dry cycle for your load. You can then change any of the automatic cycles, as desired.

**NOTE:** For some communicated wash cycles, your dryer will prompt you to select a **FABRIC CYCLE**.

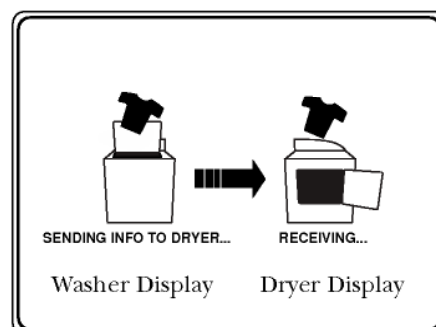

## Dry Cycles

If the Touch Screen is dark, press **POWER**, the Touch Screen, or any button to access the dry cycles menu.

The default cycle settings are based on standard load types. Always follow the fabric manufacturer's care label when laundering.

### *Drying by Fabric Type*

Select **By FABRIC** to dry loads sorted by fabric type.

FABRIC CYCLES include:

- Cottons
- Delicates
- Polyester
- Knits
- Blends
- Washable Silks



### *Drying by Garment Type*

Select **By Garment** to dry loads sorted by garment type.

GARMENT CYCLES include:

- Easy Care/Wrinkle-Free
- Blouses
- Underwear
- Jeans
- Swimwear
- Washable Silks
- Dress Shirts
- Sweaters
- Lingerie
- Delicates
- Play Clothes
- Mixed Garments
- Khakis
- Athletic Wear
- Knits
- Everyday Wear/Casual



### *Drying Using the Special Cycles*

Select **SPECIAL CYCLES** to dry loads of nongarment items, use the drying rack, or to tumble using low or no heat.

SPECIAL CYCLES include:

- Jackets/Coats
- Blankets (Cotton)
- Dryer™
- Comforter
- Blankets (Other)
- Timed Dry
- Pillows (Washable)
- Air Dry
- Sneakers
- Throw Rugs (Washable)
- Warm Up
- Towels
- Pet Bedding (Washable)
- Rack Dry
- Sheets
- Dewrinkle



### *Drying Using Timed Dry*

Select **TIMED DRY** to set your own drying time.

Timed Dry is also recommended for small loads.

- 1 Press **TIMED DRY**.
- 2 Use the arrows to set more or less time, then press **OK**.
- 3 Use the arrows to set the temperature, then press **OK**.
- 4 Press **START**.



## Summary Screen

### *About the Summary Screen*

After selecting a dry cycle, the Summary Screen displays the automatic settings for the cycle you have chosen. You can adjust these by touching the screen location for any of the settings shown.

If you change any of the automatic settings, you can save the new settings as a custom My Cycle by pressing the **MY CYCLES** button while on the Summary Screen and choosing **SAVE CURRENT SETTINGS**.

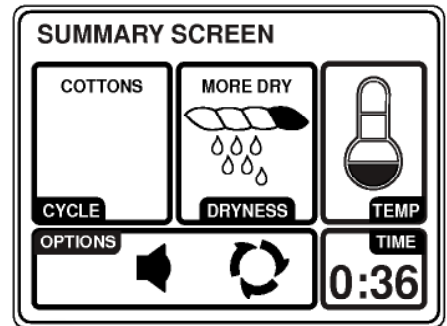

### *Changing the Dryness Level*

To change the dryness level, touch the **DRYNESS** pad on the Touch Screen; then use the arrows to select the level of dryness. Press **OK** when you have reached the desired setting.

**MORE DRY** – Use for heavy-duty fabrics.

**DRY** – Use for a normal dryness level suitable for most loads. This is the preferred cycle for energy saving.

**LESS DRY** – Use for lighter fabrics.

**DAMP** – Use to leave items partially damp.

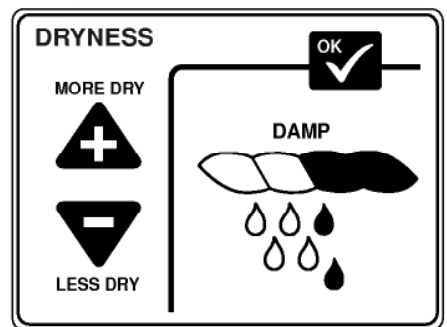

### *Changing the Drying Temperature*

To change the drying temperature, touch the **TEMP** pad on the Touch Screen, then use the arrows to select higher or lower temperature. Press **OK** when you have reached the desired setting.

**HIGH** – For regular to heavy cottons.

**MEDIUM** – For synthetics, blends and items labeled permanent press.

**LOW** – For delicates, synthetics and items labeled Tumble Dry Low.

**EXTRA LOW** – For delicates, lingerie and special-care fabrics.

**AIR DRY** – For tumbling items without heat.

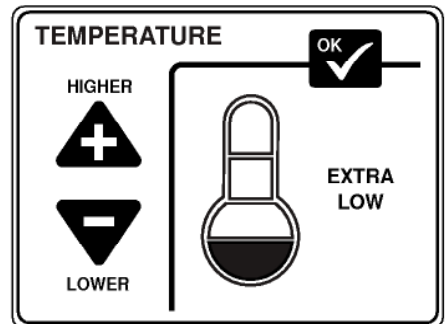

## Summary Screen

### *About the Drying Options*

Touch the **OPTIONS** pad on the Touch Screen to select drying options. After selecting any drying options, press **OK** to save your setting.

#### *Delay Start*

Touch the **DELAY START** pad repeatedly to set a delay time of up to 12 hours. The countdown time will be shown in the display.

#### *Extended Tumble*

Minimizes wrinkles by adding approximately 20 minutes of no-heat tumbling after clothes are dry. Touch **EXTENDED TUMBLE** to turn the feature on or off.

#### *End-of-Cycle Signal*

Alerts you that the cycle is complete. The beeper will continue to sound every ??? minutes for the next ??? minutes, until the clothes are removed. The clothes should be removed when the beeper goes off so wrinkles won't set in. Touch **SIGNAL** to select the volume, or to turn the beeper off.

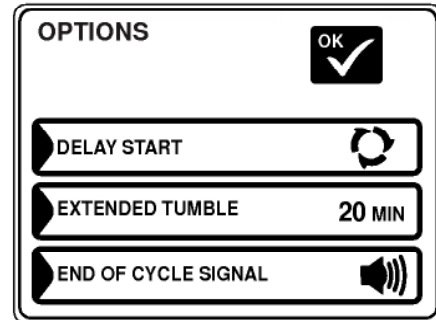

### *Adjusting the Time Settings*

You can adjust the time setting for the dry cycle, delay start and extended tumble times. Touch the **TIME** pad on the Summary Screen, then choose the time you wish to adjust.

**To change the dry cycle time**, select **CYCLE TIME**; then use the arrows to select more or less drying time.

**To change the delay start or extended tumble time**, select **DELAY START** or **EXTENDED TUMBLE**; then follow the instructions in the About the Drying Options section.

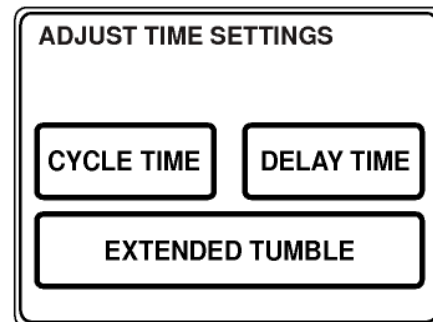

## My Cycles

---

### *About the My Cycles Feature*

The **My Cycles** feature allows you to create, store and reuse up to 6 custom cycles. Create your own cycles from scratch, or adjust the settings of a predefined dry cycle, then save for one-touch recall.

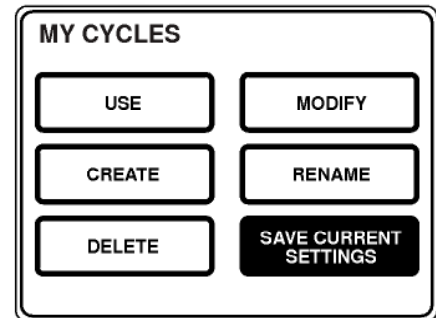

### *Creating and Using a My Cycle*

You can create **My Cycles** two ways, by either modifying a predefined dry cycle or creating a cycle from your own combination of settings and options.

#### **To build your own My Cycle:**

- 1 Press the **MY CYCLES** button.
- 2 Select **CREATE** from the Touch Screen menu.
- 3 Choose whether you want to modify a predefined cycle, or create a new cycle.
- 4 If you are modifying a predefined cycle, select the dry cycle you wish to modify.
- 5 Change any of the automatic settings and select any options.
- 6 Touch **SAVE** on the Touch Screen.
- 7 Using the keypad on the Touch Screen, type the name of your My Cycle and press **OK**.

To begin using your new My Cycle right away, select it from the Touch Screen menu and press **START**.

#### **To save a current cycle as a My Cycle:**

- 1 Select an existing cycle from the Color Cycles, Fabric Cycles, Garment Cycles, Special Cycles, or set a Timed Dry.
- 2 Change any of the automatic settings.
- 3 Press the **MY CYCLES** button.
- 4 Select **SAVE CURRENT SETTINGS** from the Touch Screen menu.
- 5 Using the keypad on the Touch Screen, type the name of your My Cycle and press **OK**.

To begin using your new My Cycle right away, select it from the Touch Screen menu and press **START**.

#### **To use a My Cycle:**

- 1 Press the **MY CYCLES** button.
- 2 Select **USE** from the Touch Screen menu.
- 3 Select the cycle name from the Touch Screen menu.
- 4 Change any of the automatic settings and select any options.
- 5 Press **START**.

## My Cycles

---

### *Modifying, Renaming, or Deleting a My Cycle*

#### To modify the settings of a My Cycle:

- 1 Press the **MY CYCLES** button.
- 2 Select **MODIFY** from the Touch Screen menu.
- 3 Select the cycle name from the Touch Screen menu.
- 4 Change any of the automatic settings and select any options.
- 5 Press **SAVE** on the Touch Screen.

#### To rename a My Cycle:

- 1 Press the **MY CYCLES** button.
- 2 Select **RENAME** from the Touch Screen menu.
- 3 Select the cycle name from the Touch Screen menu.
- 4 Using the keypad on the Touch Screen, type the name of your My Cycle and press **OK**.

#### To delete a My Cycle:

- 1 Press the **MY CYCLES** button.
- 2 Select **DELETE** from the Touch Screen menu.
- 3 Select the cycle name from the Touch Screen menu.
- 4 Choose **YES** to delete the cycle or **CANCEL** to return to the list of My Cycles.

## Help

---

### *About the Help Feature*

Pressing the **HELP** button from the Home Screen allows you to locate troubleshooting tips for common dryer problems, to find help with using the Home Screen, or to set machine preferences.

Pressing the **HELP** button while on any other screen allows you to find additional information on features found on that screen. Press **HELP**; then touch any pad on the Touch Screen for an explanation of that feature. To exit the feature, press **HELP** once to return to the previous screen or twice to exit Help.

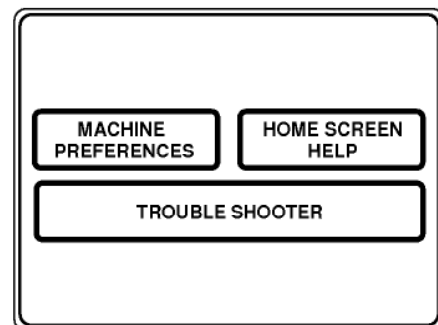

### *Using the Troubleshooter*

To locate Troubleshooting Tips for common dryer problems:

- 1 Press the **HELP** button.
- 2 On the Touch Screen, select **TROUBLE SHOOTER**.
- 3 On the Touch Screen, select the problem description from the list. You can use the arrows at the right of the screen to scroll up and down through the list of additional problems.
- 4 On the Touch Screen, select a possible cause for the problem and follow the on-screen instructions to find a solution.

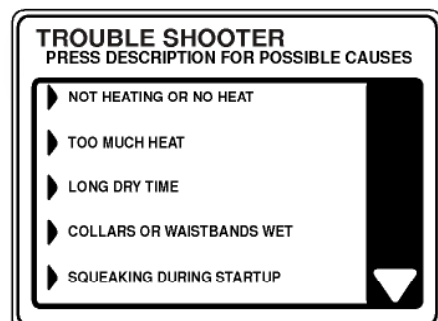

## Help

### *Finding Help Using the Home Screen*

Pressing the **HELP** button then selecting **HOME SCREEN HELP** allows you to find additional information on features found on the Home Screen. Touch any pad on the Touch Screen for an explanation of that feature. To exit the feature, press the **BACK** button.

### *Setting the Machine Preferences*

The machine settings on the Help feature allow you to set the display language of the Touch Screen, control the volume of the button beep and end-of-cycle signal, and turn the washer/dryer communication feature on or off.

Press the **HELP** button, then select from the on-screen options.

#### **Button Beep**

The button beep controls the volume of the beep that is made when you press any of the buttons on the control panel or Touch Screen.

#### **To change the volume of the button beep:**

- 1 From the Home Screen, press the **HELP** button.
- 2 Select **MACHINE PREFERENCES** from the Touch Screen.
- 3 Select **BUTTON BEEP** from the Touch Screen.
- 4 Use the arrows to make the volume louder or softer, or to turn the beep off.
- 5 Select **OK** from the Touch Screen.

#### **Washer/Dryer Communication**

Washer/Dryer communication allows your dryer to receive cycle information from your washer once the wash cycle is complete. Once the information is sent, your dryer can then create the optimal dry cycle for your load.

#### **To turn the Washer/Dryer Communication feature on or off:**

- 1 From the Home Screen, press the **HELP** button.
- 2 Select **MACHINE PREFERENCES** from the Touch Screen.
- 3 Select **WASHER/DRYER COMMUNICATION** from the Touch Screen.
- 4 Touch the pad at the bottom of the Touch Screen to select **ON** or **OFF**.
- 5 Select **OK** from the Touch Screen.

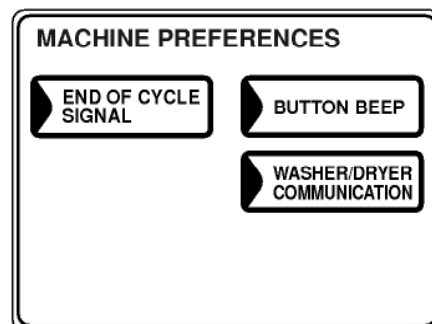

#### **End-of-Cycle Signal**

The End-of-Cycle signal alerts you when the cycle is complete.

#### **To change the volume of the end-of-cycle signal:**

- 1 From the Home Screen, press the **HELP** button.
- 2 Select **MACHINE PREFERENCES** from the Touch Screen.
- 3 Select **END OF CYCLE SIGNAL** from the Touch Screen.
- 4 Use the arrows to make the volume louder or softer, or to turn the signal off.
- 5 Select **OK** from the Touch Screen.

## Component Locator View

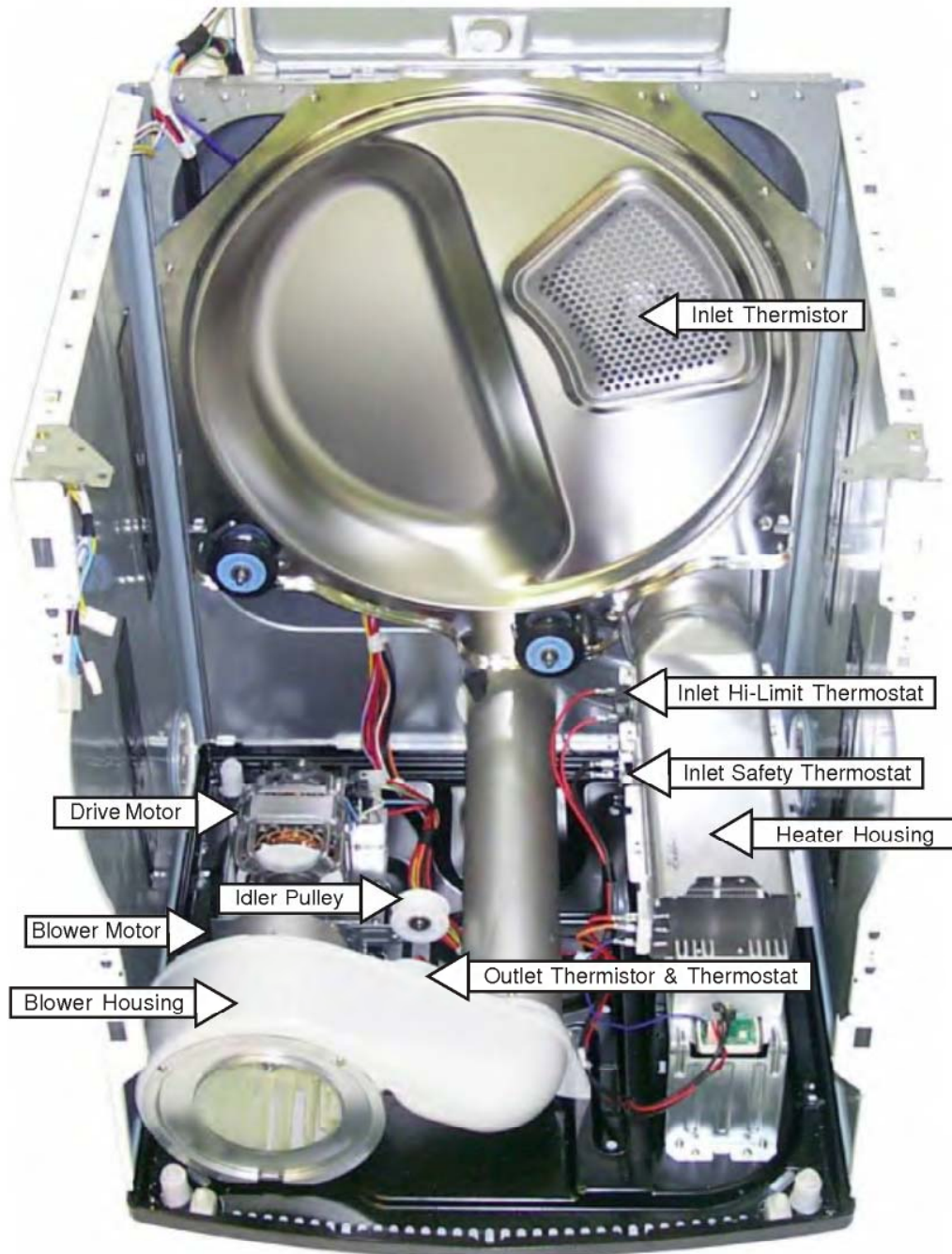

Electric Model

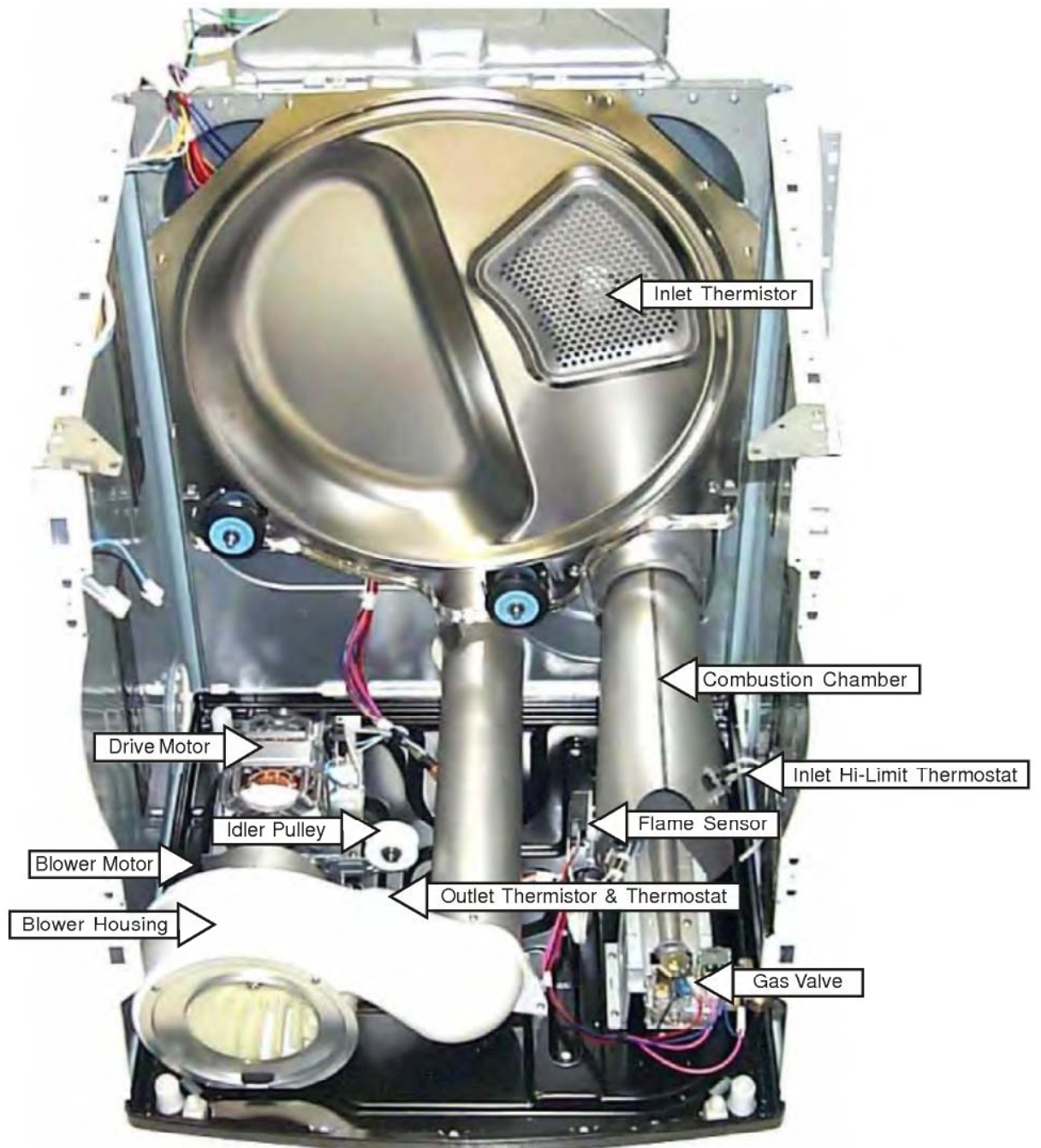

## Gas Model

# Dryer Components

## Backsplash

To remove the backslash:

1. Remove 4 screws from the rear of the backslash.



2. Place a towel over the lid of the washer to prevent scratches to the surface. Gently lift each corner of the backslash, then roll it forward so it rests on top of the dryer.
3. Disconnect the wiring to the key panel, then remove the backslash.

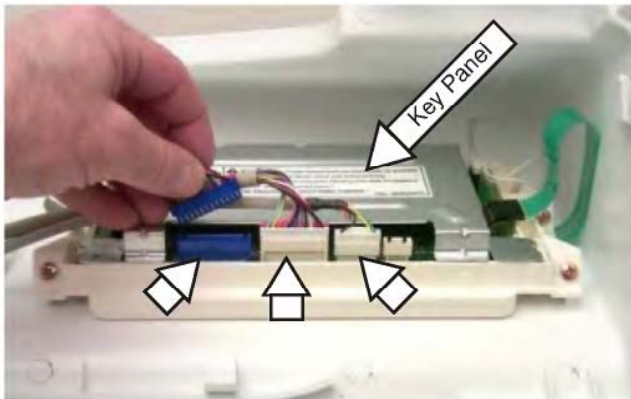

## Inverter

To access and remove the inverter board:

1. Remove the backslash (see *Backslash*).
2. Remove the 2 screws that hold the inverter box in place.

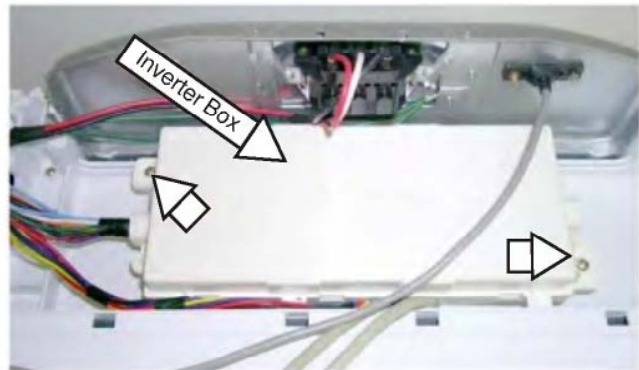

3. Slide the inverter box toward the rear of the dryer and lift out.
4. With a flat blade screwdriver, press the tabs on the side of the inverter box and gently pry it open.

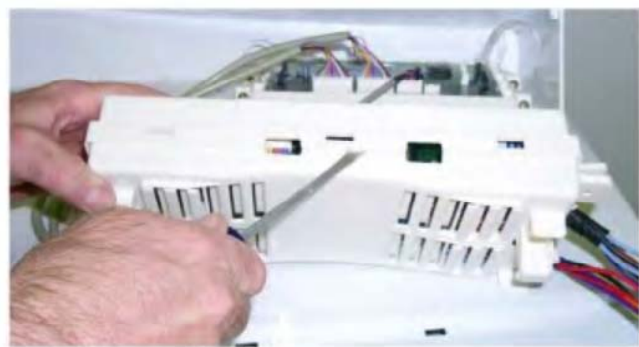

5. Disconnect the wiring from the inverter board then remove the inverter board.

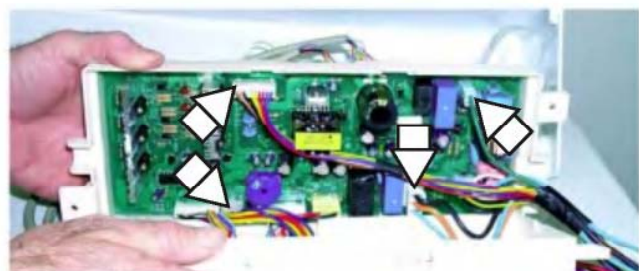

## Top Panel

The top panel is held in place by 2 rear screws and 2 tabs located in the front.

### To remove the top panel:

1. Remove the backsplash (see *Backsplash*).
2. Remove the 2 screws that hold the inverter box in place (see *Inverter*).
3. Place the inverter box off to the side of the dryer.
4. Slide the wiring harness guard out, then disconnect the wires from the \_\_\_\_\_.

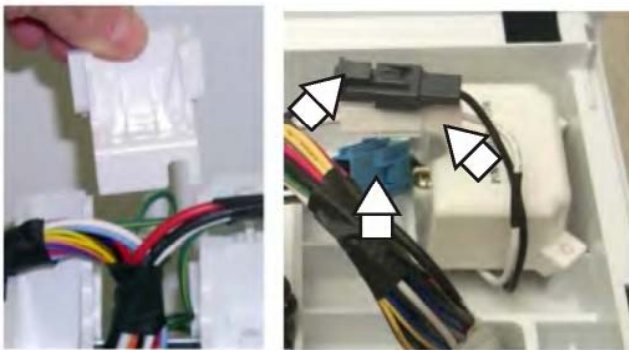

4. Remove the 2 rear screws that hold the top panel in place.



5. Lift the top panel and slide it forward to clear the front tabs.



## Front Panel

**WARNING:** Sharp edges may be exposed when the inner top panel is removed. Use caution to avoid injury when servicing dryer.

### To remove the front panel:

1. To access the 2 top screws securing the front panel, remove the backsplash and top panel (see *Backsplash* and *Top Panel*).
2. Remove the 2 screws securing the front panel to the side panels.



3. Remove the 4 screws from the front panel then remove the front panel.



4. Lift and tilt the front panel forward slightly to disconnect wiring to the door switch.

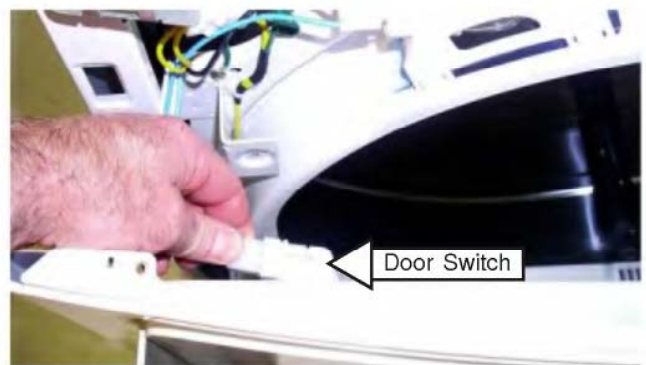

5. Remove the front panel .

## Drum

**WARNING:** Sharp edges may be exposed. Use extreme caution when removing the drum.

The dryer drum is made of stainless steel and has 3 replaceable drum vanes attached to the inside.

### To remove the drum:

1. Remove the top panel and the front panel. (See *Top Panel* and *Front Panel*.)
2. The inner top panel is held in place by 4 screws (2 on each side) and 2 plastic rails (1 on each side). Remove the 4 screws then the plastic rails.

**Tech Tip:** The drum *can* be removed without removing the inner top panel if desired. However, installation and removal of the drum can be difficult due to the constricting space around the drum if the inner top panel is left in place.

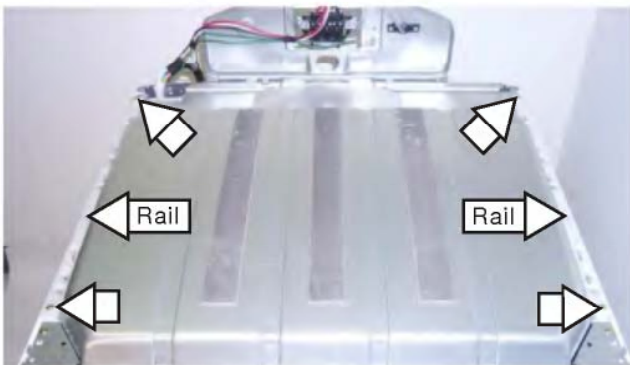

3. Disconnect wiring to the drum light, and sensor rods.

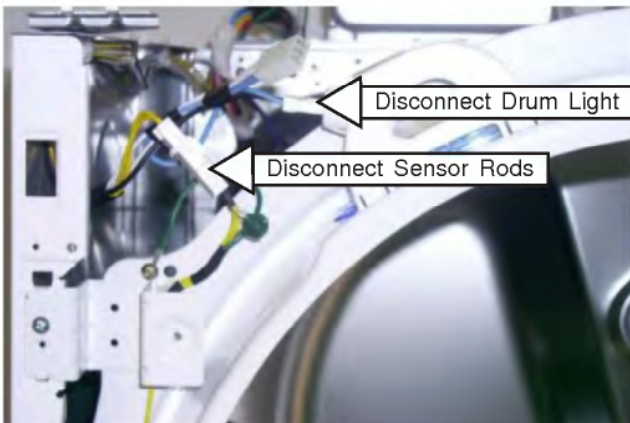

5. Remove the 4 screws that hold the drum support to the sides of the dryer.

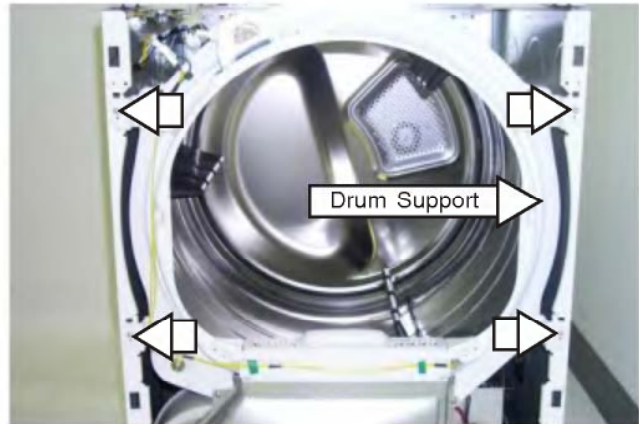

6. Grasp the top outside edges of the drum support and unsnap the 4 corners from the sides of the dryer.
7. Remove the drive belt from the motor. (See *Drive Belt*.)
8. Using the belt as a handle, pull the drum forward and guide it out of the dryer cabinet.

## Door Switch

The door switch is fastened to the front panel by 2 locking tabs and is common to all dryer functions. When the dryer door is closed, the switch will complete the motor circuit, allowing dryer operation. When the dryer door is open, the switch will open the motor circuit, interrupting dryer operation. Opening the dryer door will also cause the door switch to close the drum light circuit, allowing the drum light to be energized.

### Door Switch Strip Circuit

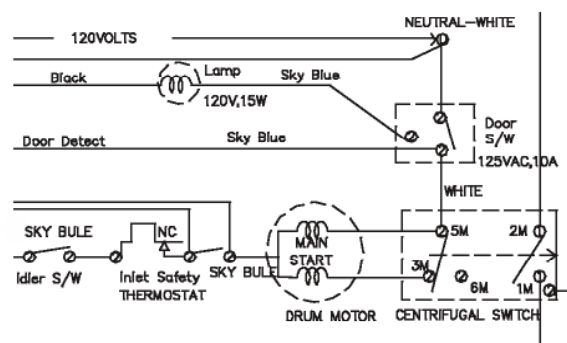

## Drum Light

The drum light is a screw-in 10-watt, 120-VAC bulb located in the top of the front panel and switched on the neutral side by the door switch. Replace only with a bulb of the same size and type. Part # \_\_\_\_\_.

Remove the screw in the bulb lens to access the bulb.



## Drive Belt

The drive belt extends from the motor pulley, past the idle pulley, and around the perimeter of the dryer drum. Part # \_\_\_\_\_.

### To remove the drive belt:

1. Remove the top panel, front panel, and drum. (See *Top Panel, Front Panel and Drum.*)
2. Reach under the left side of the drum, push the idler pulley to the left to take tension off the belt.
3. Remove the belt from the motor pulley and idler pulley, then pull the belt through the front of the dryer.

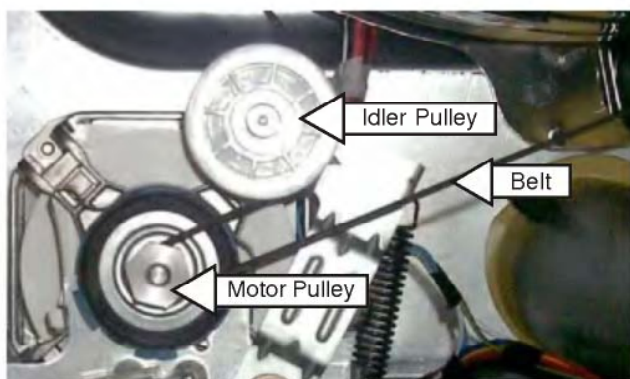

### To install the drive belt:

1. Place the belt in position around the center of the drum.
  2. Reach under the left side of the drum and place the belt in position around the motor pulley. Push the idler pulley to the left and place the belt onto the idler pulley.
  3. Release the idler pulley and guide the belt into position.
  4. Install the drum support (see *Drum*).
- Note:** Lift the drum slightly to line up the drum with the drum support.
5. Check to make sure the belt is in place and not twisted before installing the top and front panels.

## Belt Switch

The belt switch is activated by the idler pulley. It is fastened to the motor bracket by 2 screws. If the drive belt breaks, the belt switch opens the drive motor circuit, interrupting dryer operation.

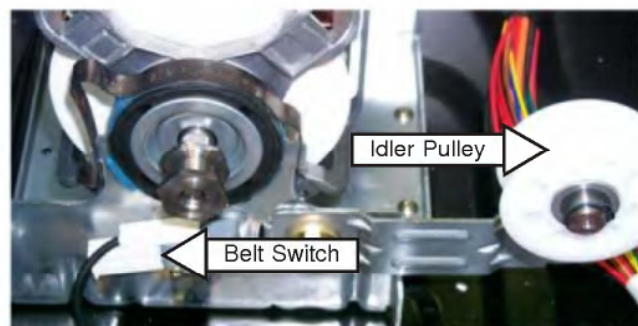

### To remove the belt switch:

1. Remove the top panel, front panel, and drum. (See *Top Panel, Front Panel and Drum.*)
2. Disconnect the wiring to the belt switch.
3. Remove the the 2 screws that secure the belt switch to the motor bracket.

## Drive Motor

### To remove the drive motor:

The drive-motor is a single-speed,  $\frac{1}{3}$ -hp motor with an automatic reset overload protector. The overload protector is an internal component of the motor and cannot be replaced separately. The motor contains a centrifugal switch that serves three purposes: It disengages the motor start winding, engages the motor run winding, and closes the circuit contacts for the heat source

1. Disconnect power to the unit.
2. Remove the top panel, front panel, and drum. (See *Top Panel, Front Panel, and Drum.*)
3. Disconnect the motor wiring.
4. With a flat blade screwdriver compress the open end of the spring strap until it releases. (One strap on each end of the drive motor.)

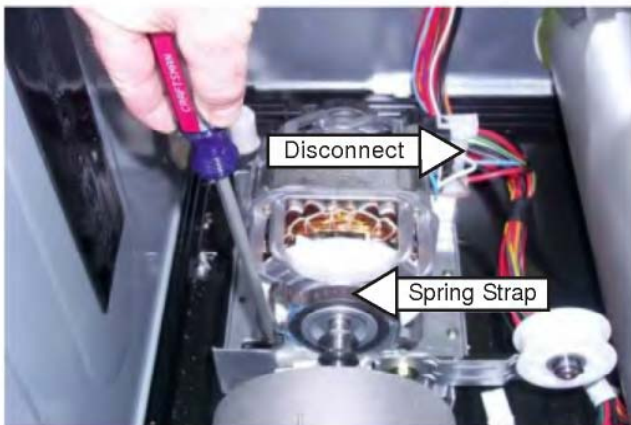

5. Remove the spring straps, then remove the drive motor from its cradle.

### Drive Motor Strip Circuit

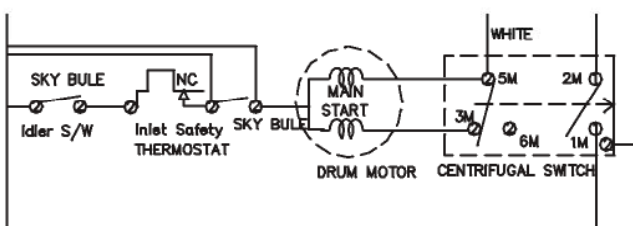

## Blower Motor

### To remove the blower motor:

The blower housing must be removed to access the blower motor.

1. Disconnect power to the unit.
2. Remove the top panel, front panel and drum. (See *Top Panel, Front Panel, and Drum.*)
3. Disconnect the outlet thermistor and outlet thermostat wiring located on the back side of the blower housing.
4. Disconnect the motor wiring.

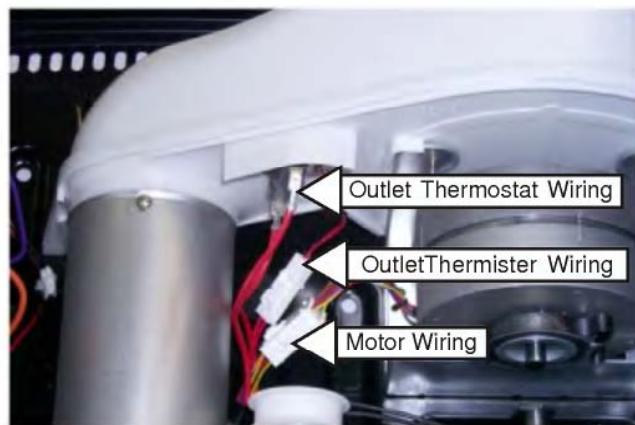

5. Remove the 2 blower guard screws, then remove the blower guard.

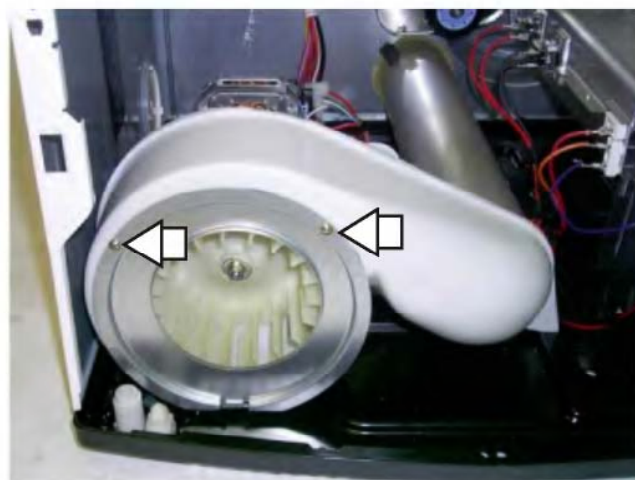

## Blower Motor (Cont.)

- Remove the center nut, then remove the blower wheel.



- Remove the 3 screws securing the blower housing to the housing bracket

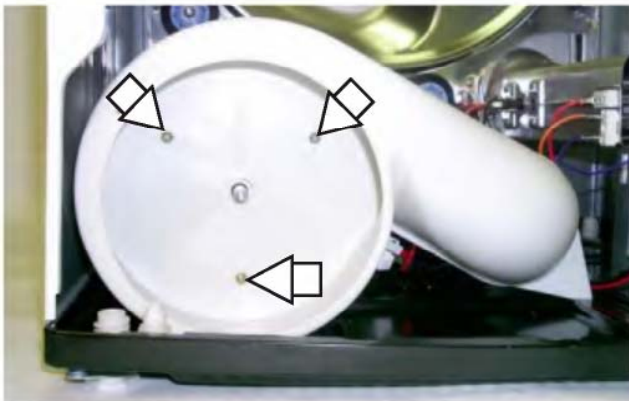

- Remove the 2 screws securing the dryer base and exhaust duct.

Top View

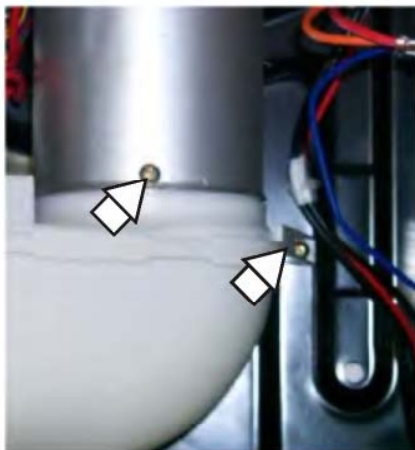

- Remove the motor shaft snap ring.



- Remove the blower housing.
- With a flat blade screwdriver compress the open end of the spring strap until it releases. (One strap on each end of the drive motor.)



- Remove the spring straps, then remove the drive motor from its cradle.

## Blower Motor Strip Circuit

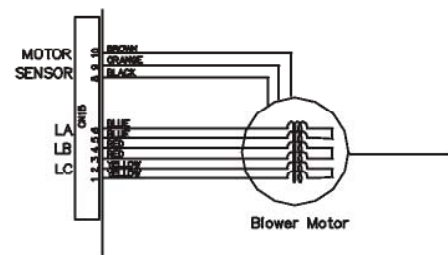

## Heater Assembly (Electric Models)

The heater assembly is located below the drum and consists of 2 rows of coils installed in a rectangular metal housing. The open end in the back of the housing allows air to be drawn over the heating coils and into the drum. The heating coils should have a resistance value of XX.

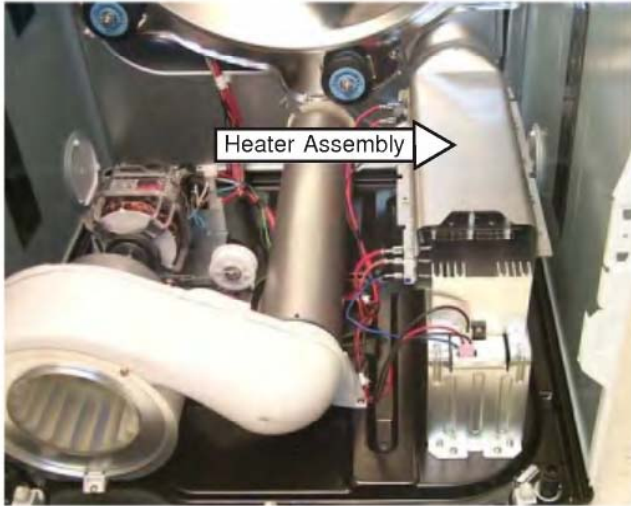

### To remove the heater assembly:

1. Remove the top panel, the front panel, and the drum. (See *Top Panel*, *Front Panel*, and *Drum*.)
2. Note their locations and disconnect all wiring to the heater assembly.

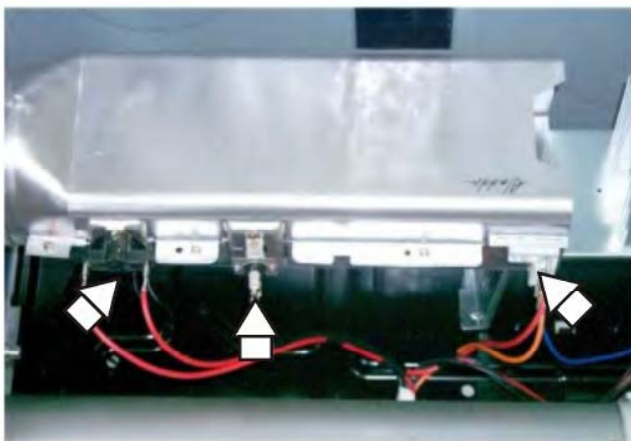

3. Remove the 2 screws that hold the heater assembly in place.

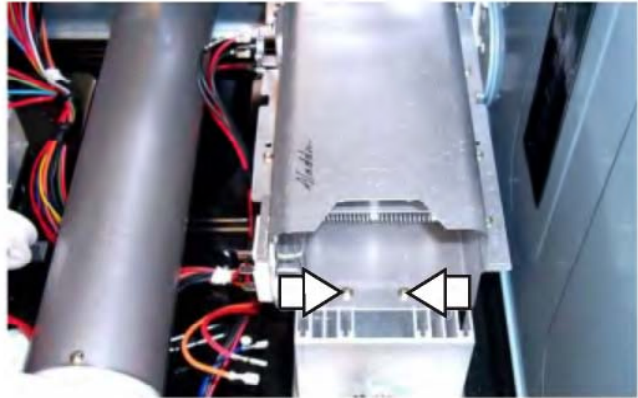

4. Remove the heater assembly.



## Inlet Thermistor

The inlet thermistor is located on the inside of the drum support on both the electric and gas model.

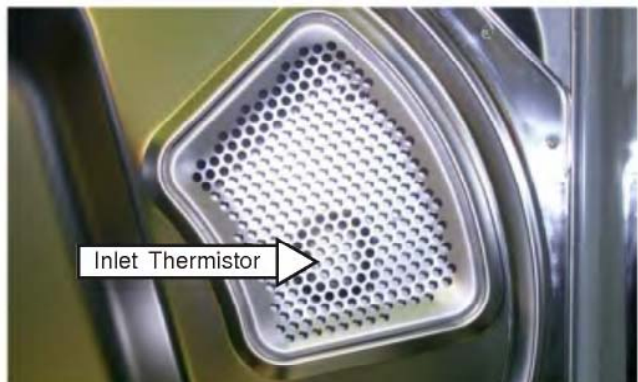

## Inlet Thermistor (Cont.)

The inlet thermistor measures the incoming air temperature and responds to temperature changes. The inlet thermistor provides temperature change information to the electronic control board. The electronic control board makes heating decisions based on this information.

At room temperature the inlet thermistor has a resistance value of 2.27 K-ohms +/- 5%.

### To remove the thermistor:

1. Remove the inlet thermistor access cover located on the back of the dryer.
2. Disconnect the thermistor wiring,

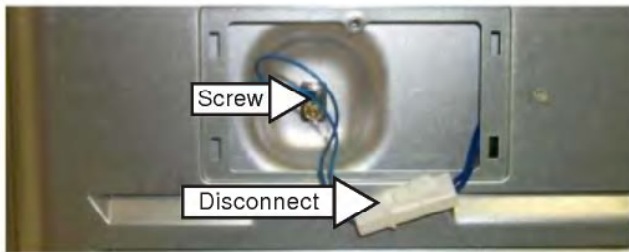

3. Remove the screw that holds the thermistor in place, then remove the thermistor.

### Inlet Thermistor Strip Circuit

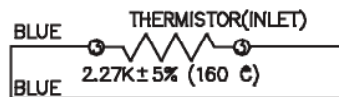

## Safety Thermostat

The hi-limit thermostat is located on the left side of the heater housing on electric models. It is located on left lower side of the combustion chamber on gas models

### Electric Model Location

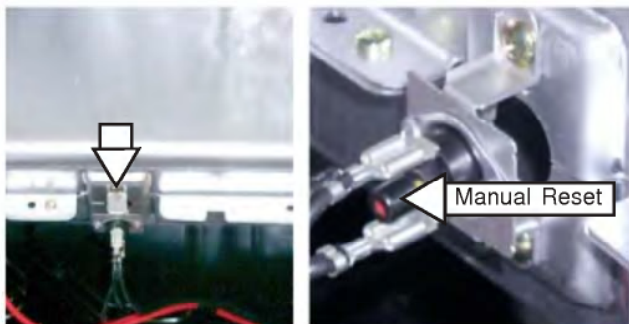

### Gas Model Location

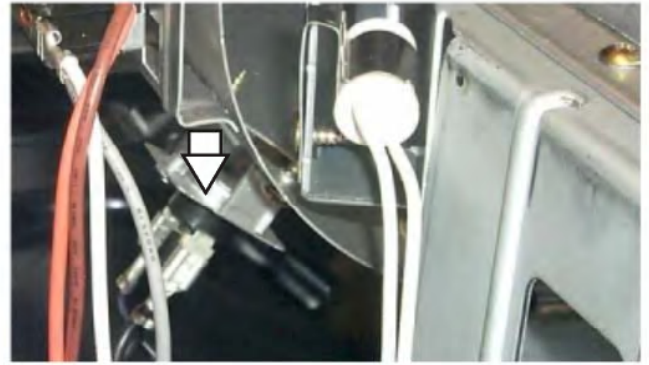

The safety thermostat monitors incoming air temperature. If the safety thermostat reaches a temperature beyond its maximum temperature rating, it will trip and disable all dryer functions. Dryer functions will be restored when the safety thermostat cools and resets.

The safety thermostat can also be reset manually by pressing the reset button on the back (see photo.)

**Note:** The safety thermostat on the electric models has a trip temperature of 248°F and a reset temperature of 32°F.

The safety thermostat on the gas models has a trip temperature of 212°F and a reset temperature of 32°F.

### To remove the safety thermostat:

1. Remove the top panel, the front panel, and the drum. (See Top Panel, Front Panel and Drum.)
2. Disconnect the safety thermostat wiring.
3. Remove the 2 screws that hold the safety thermostat in place.
4. Remove the safety thermostat.

### Safety Thermostat Strip Circuit

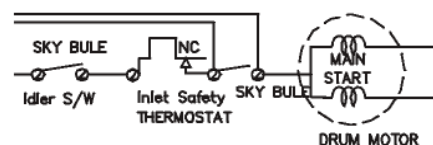

## Outlet Thermistor

The outlet thermistor is located on the blower housing on both the gas and electric models.

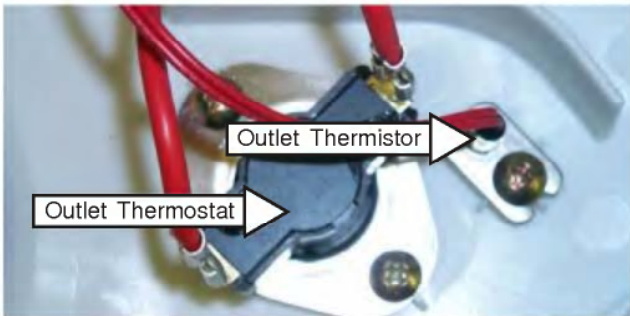
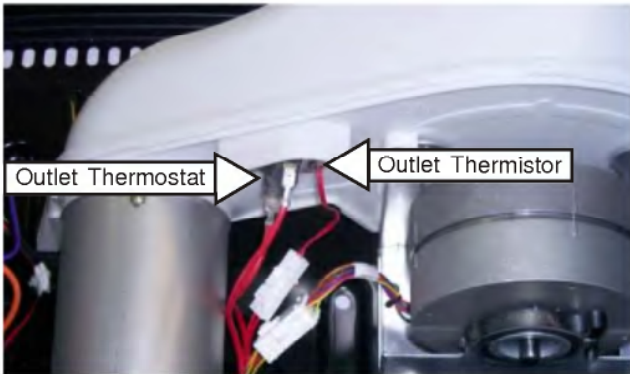

The outlet thermistor measures outgoing air temperature and responds to temperature changes. The outlet thermistor provides temperature change information to the electronic control board. The electronic control board makes heating decisions based on this information.

At room temperature the outlet thermistor has a resistance value of 10 K-ohms +/- 3%.

### To remove the outlet thermistor:

1. Remove the top panel, the front panel, and the drum. (See Top Panel, Front Panel, and Drum.)
2. Disconnect the thermistor wiring.
3. Remove the screw that holds the thermistor in place.
4. Remove the thermistor.

### Outlet Thermistor Strip Circuit

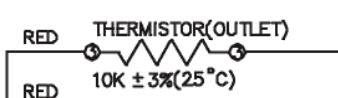

## Outlet Thermostat

The outlet thermostat is located on the blower housing on both the gas and electric models (see photos.)

The outlet thermostat monitors outgoing air temperature. If the outlet thermostat reaches a temperature beyond its maximum temperature rating, it will trip and disable the heating function. The heating function will be restored when the outlet thermostat cools and resets.

The outlet thermostat on the electric model has a trip temperature of 189°F and a reset temperature of 153°F.

The outlet thermostat on the gas model has a trip temperature of 185°F and a reset temperature of 149°F.

### To remove the outlet thermostat:

1. Remove the top panel and the front panel. (See Top Panel and Front Panel.)
2. Disconnect the thermostat wiring.
3. Remove 2 screws that secure the outlet thermostat to the blower housing.
4. Remove the outlet thermostat.

### Outlet Thermostat Strip Circuit Electric Model

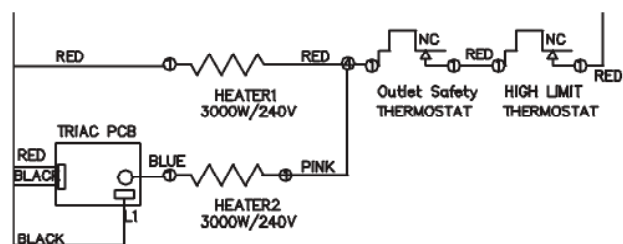

### Out-Let Thermostat Strip Circuit Gas Model

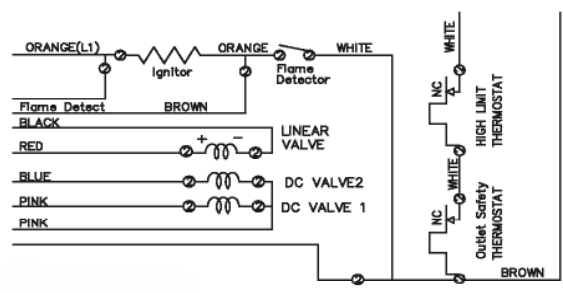

## Hi-Limit Thermostat

The hi-limit thermostat is located on the left side of the heater housing on electric models. It is located on the right upper side of the combustion chamber on gas models.

### Electric Model Location

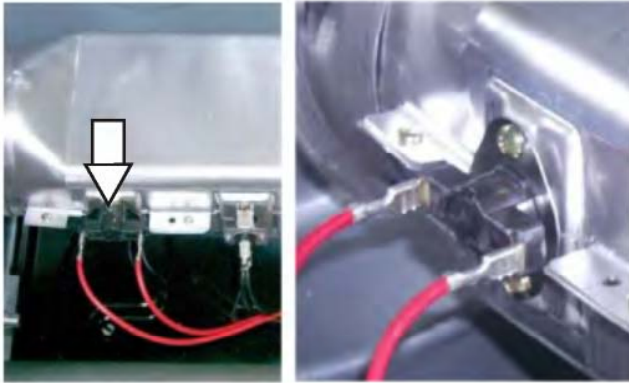

### Gas Model Location



The hi-limit thermostat monitors incoming air temperature. If the hi-limit thermostat reaches a temperature beyond its maximum temperature rating, it will trip and disable the heating function. Heating functions will be restored when the hi-limit thermostat cools and resets.

The hi-limit thermostat on the electric models has a trip temperature of 230°F and a reset temperature of 194°F.

The hi-limit thermostat on the gas models has a trip temperature of 194°F and a reset temperature of 158°F.

### To remove the hi-limit thermostat:

1. Remove the top panel, front panel, and drum. (See Top Panel, Front Panel, and Drum.)
2. Disconnect the lead wires to the hi-limit thermostat.
3. Remove the 2 screws that secure the hi-limit thermostat to the housing.
4. Remove the hi-limit thermostat.

### Hi-Limit Thermostat Strip Circuit Electric Model

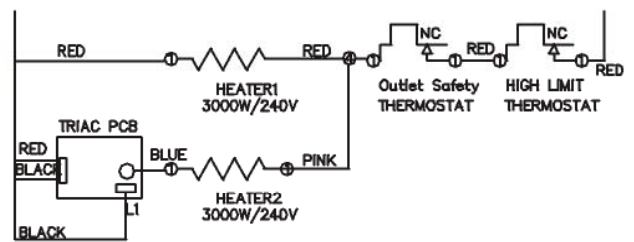

### Hi-Limit Thermostat Strip Circuit Gas Model

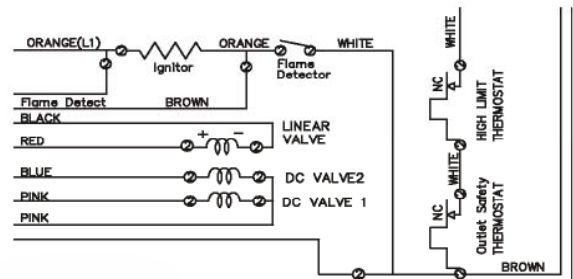

## Gas Valve

The gas valve is located in the bottom right corner of the dryer cavity.



### To remove the gas valve:

1. Shut the gas off to the unit.
2. Remove the top panel and front panel. (See *Top Panel* and *Front Panel*.)
3. Disconnect all wiring to the gas valve and ignitor.
4. Remove the 2 screws securing the gas valve to the elbow coupling.
5. Remove the 2 screws securing the gas valve assembly to the dryer floor.

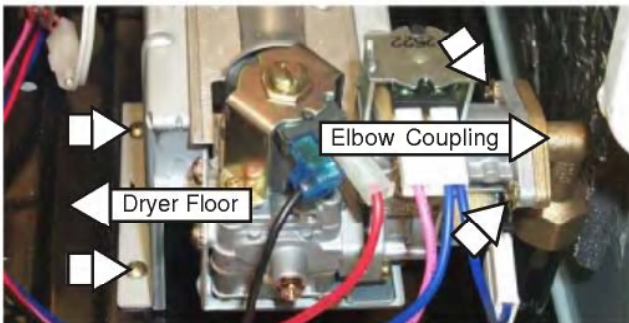

6. Slide the gas valve assembly out through the front of the dryer cavity.
7. Remove the 3 screws that secure the gas valve to the mounting assembly, then remove the gas valve.

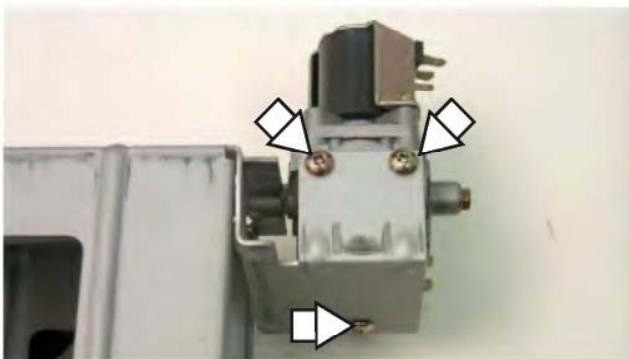

## Ignitor

The ignitor is located at the end of the gas valve assembly in front of the combustion chamber opening.

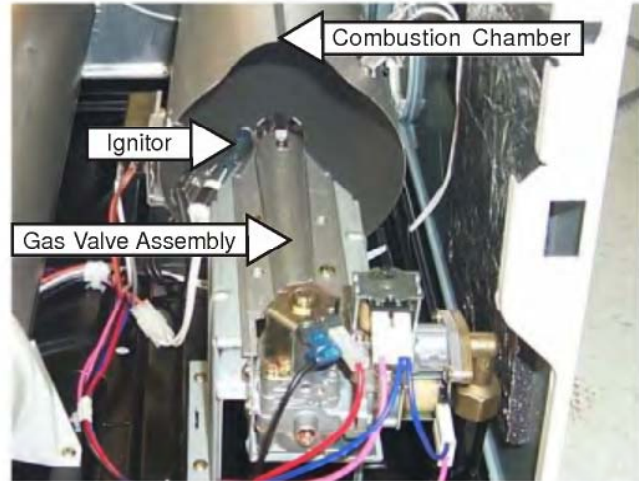

### To remove the ignitor:

1. Shut the gas off to the unit.
2. Remove the top panel and front panel. (See *Top Panel* and *Front Panel*.)
3. Remove the gas valve assembly (see steps 3 through 6 under *Gas Valve*).
4. Remove the screw securing the ignitor to the assembly, then remove the ignitor.



### Ignitor Strip Circuit

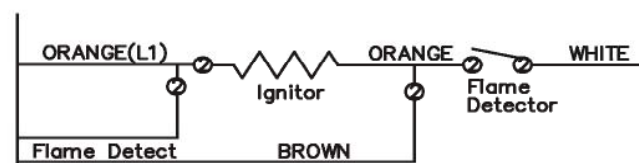

## Glo-Bar Igniter Circuit Operation

The glo-bar igniter circuit is made up of the following components: a gas valve with safety and main valves, a glo-bar igniter, and a flame detector. The safety valve is actuated by a double coil, that comprises a safety coil (resistance approximately 1400 ohms) and a booster coil (resistance approximately 580 ohms). Both coils are needed to open the safety valve. Once energized, the safety coil alone will hold the valve open. The main valve has a single coil (resistance approximately 1300 ohms).

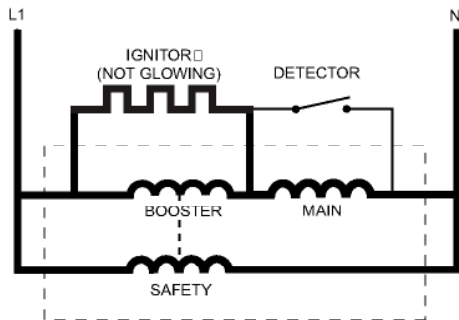

Ignitor On

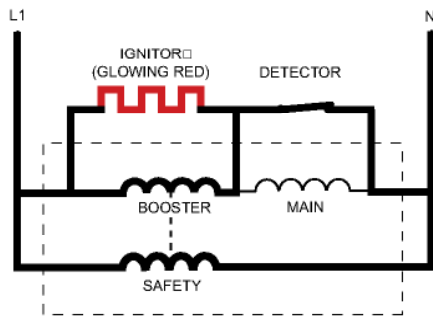

Gas Valve Open

The flame detector (< 1 ohm) is mounted on the combustion chamber. It is normally in the closed position (N.C.). The flame detector is opened by the radiant heat produced by the glo-bar; and once open, the flame detector will be held open by the radiant heat produced by the gas flame.

When the control system calls for heat, the following circuits are energized:

1. N- through detector, igniter, outlet control backup, inlet safety thermostats to L1.
2. N- through detector, booster coil, outlet control backup, inlet safety thermostats to L1.
3. N- through safety coil and outlet control backup, inlet safety thermostats to L1.

When the glo-bar is heating, the booster and safety coils are both energized and will open the safety valve. The main valve is closed as its coil is bypassed by the N.C. flame detector. When the glo-bar reaches ignition temperature, approximately 60 seconds or less, the flame detector is heated and opens, which places the main coil in series with the glo-bar. The main valve opens, allowing gas to flow into the combustion chamber and ignite.

The main coil, now in series with the glo-bar, causes the glo-bar to cool down. However, the flame detector is held open by the radiant heat from the gas flame.

The booster coil is now also in series with the main coil and is essentially inoperative. Should a momentary power failure occur, the gas valve will shut off and an attempt to restart will not occur until the flame detector cools and resets, approximately 30 seconds .

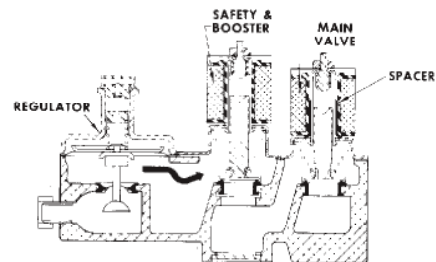

Valves Closed

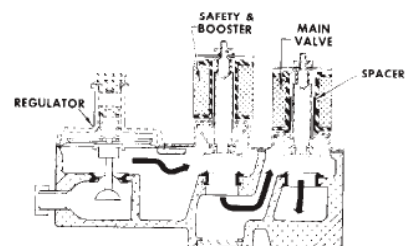

Valves Open

## Airflow Diagram (Gas and Electric Models)

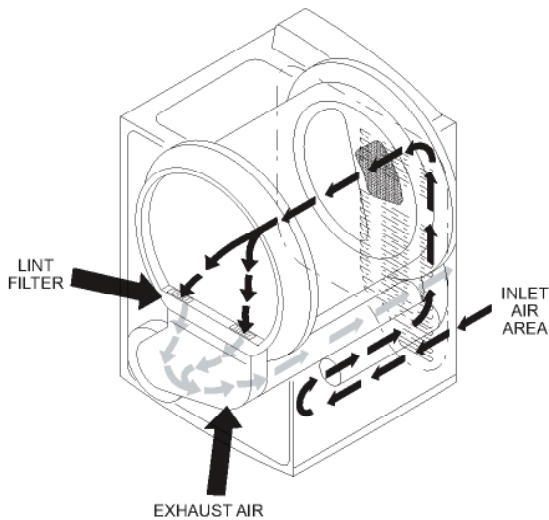

## Sensor Rod Circuit

The moisture-sensing rods are part of a circuit that is designed to utilize a low-voltage capacitor that charges to 5 VDC when the circuit is open and discharges to 1 VDC when the circuit is shorted.

A space between the 2 rods causes an open in the sensor rod circuit. When wet clothes touch the two rods, they create a short, which discharges the capacitor. When the clothes become dry, they cannot short the circuit; and the charge across the capacitor builds to 5 VDC.

If the electronic control board reads 1 VDC across the capacitor, it is determined that the clothes are wet. As the clothes are dried, the voltage across the capacitor increases. When the electronic control board reads 5 VDC across the capacitor, it is determined that the clothes are completely dry.

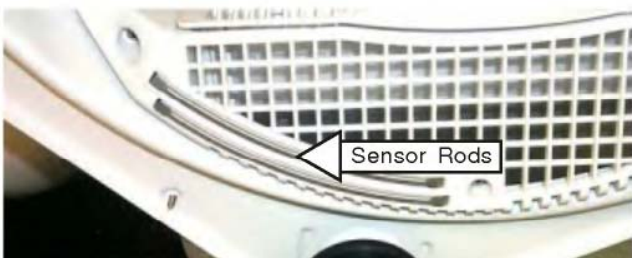

**Note:** Proper leveling of the dryer is vital for accurate sensor drying. Excessive rearward adjustment will cause clothes to tumble toward the rear of the drum, preventing contact with the sensor rods, thus producing a false dryness reading.

## Electronic Control Boards

The dryer has 2 electronic control boards. The key panel board is attached to the back of the backsplash and controls \_\_\_\_\_. The inverter board is enclosed in a protective case and controls \_\_\_\_\_ (see *Inverter* for access and removal instructions). It is located on top of the dryer under the control panel.

If a faulty board is suspect, visually inspect the components mounted on the board. If any component appears burnt or damaged, replace the board.

**Caution:** To prevent electrostatic discharge, ground yourself to the dryer cabinet or use an ESD wristband.

## Key Panel Board (protective cover removed)



## Inverter Board



# Switching the Washer and Dryer Backsplashes

## Overview

When viewed from the front, the washer is shipped for installation on the left and the dryer is shipped for installation on the right. If the hose utility connections are arranged so that the units must be installed with the washer on the right and the dryer on the left, the backsplashes of the washer and dryer can be switched in order to maintain the proper curved appearance.

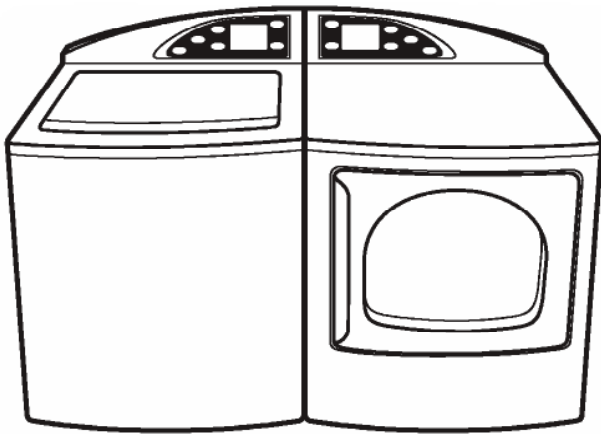

## Tools Needed



#2 Screwdriver



Towel (2)

## WARNING!

- Make sure the washer and dryer are unplugged.
- Turn both the home hot and cold water valves to the off position.
- Turn the home gas shut-off valve to the off position (for gas dryer models).

## To switch the washer and dryer backsplashes:

1. Place a towel over the lid of the washer to prevent scratches to the surface.
2. Remove the 2 screws from the washer backsplash.
3. Rotate backsplash forward and lift off.

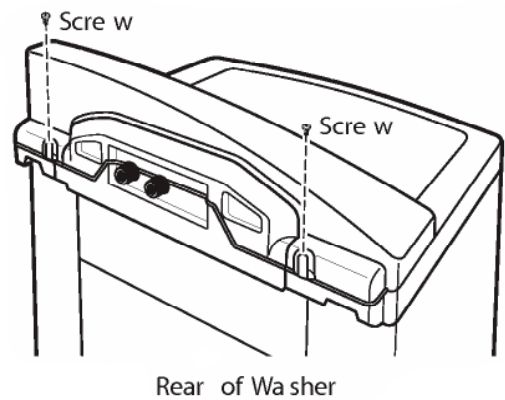

4. Disconnect the ribbon at the right of the washer keypanel by pulling up on the connector that holds the ribbon in place and pulling the ribbon out.

**Note:** Do not disconnect any other wires from the washer keypanel.

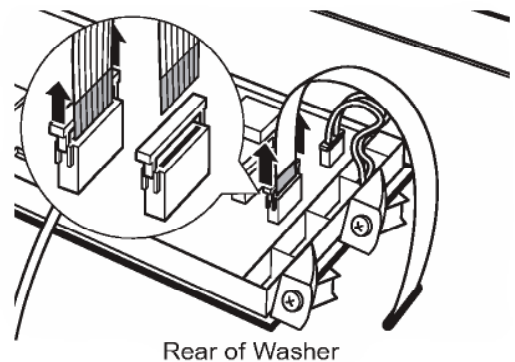

## Switching the Washer and Dryer Backsplashes (Cont.)

5. Remove the four screws holding the washer keypanel to the backslash then remove the keypanel and set it aside.

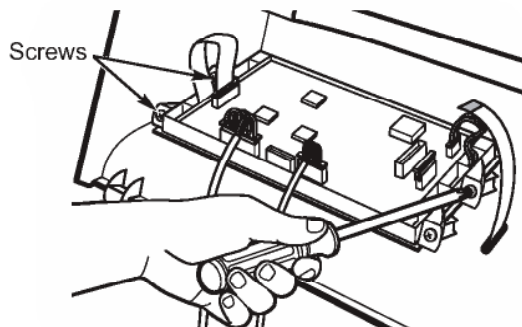

6. Place a towel over the top surface of the dryer to prevent scratches to the surface.
7. Remove the four screws from the dryer backslash.
8. Rotate backslash forward and lift off.

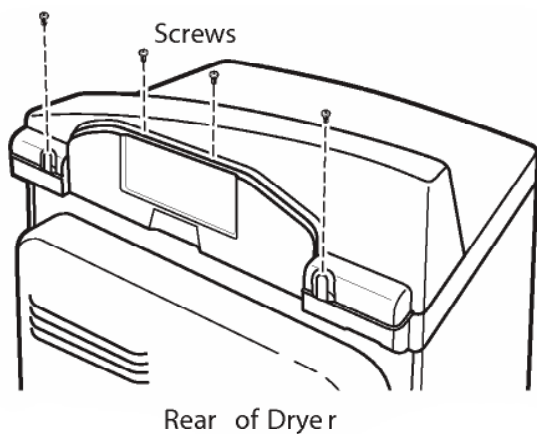

9. Disconnect the ribbon at the right of the dryer keypanel by pulling up on the connector that holds the ribbon in place and pulling the ribbon out.

**Note:** Do not disconnect any other wires from the dryer keypanel.

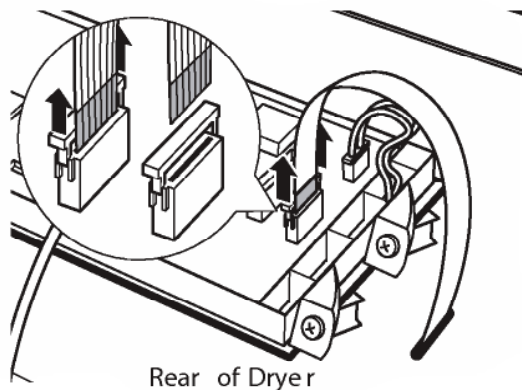

10. Remove the four screws holding the dryer keypanel to the backslash.
11. Remove the dryer keypanel and set it aside.

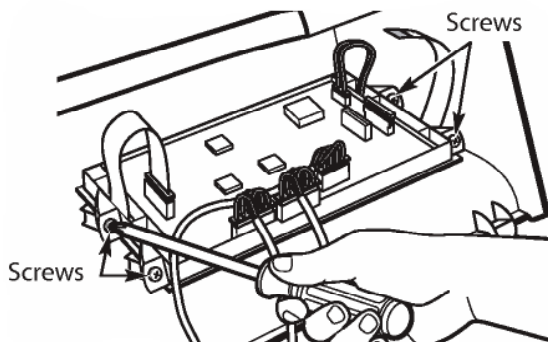

## Switching the Washer and Dryer Backsplashes (Cont.)

- Place the backslash from the dryer on top of the washer and place the backslash from the washer on top of the dryer.

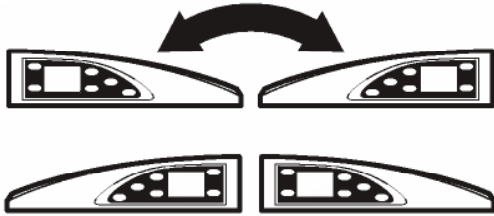

- Attach the dryer keypanel to the new backslash by replacing the four screws removed from the dryer keypanel earlier.

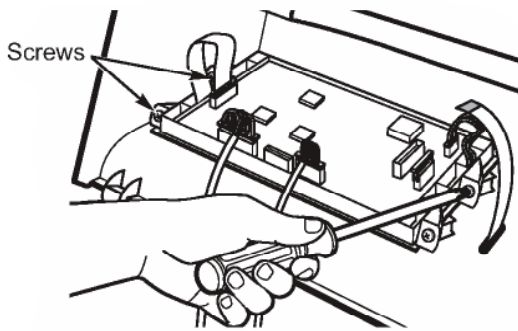

- Connect the dryer keypanel to the new backslash by inserting the ribbon from the new backslash into the dryer keypanel and pushing down on the connector.

**Note:** The colored end of the ribbon does not go all the way into the connector. Make sure the ribbon is not twisted before inserting into the connector.

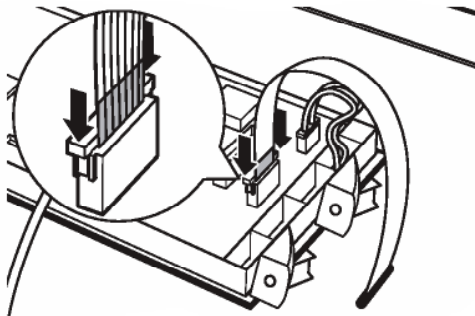

- Place the gray wire from the serial port under the strain relief of the new backslash.

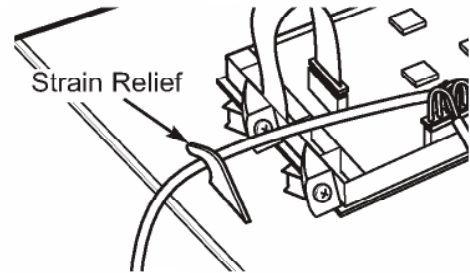

- Insert the tabs on the bottom front of the new backslash into the slots on the dryer and rotate the backslash into place.

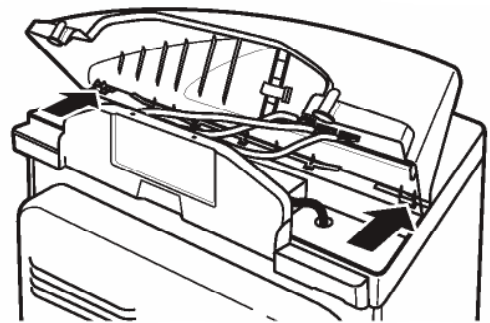

- Secure the new backslash to the dryer using the four screws removed earlier.

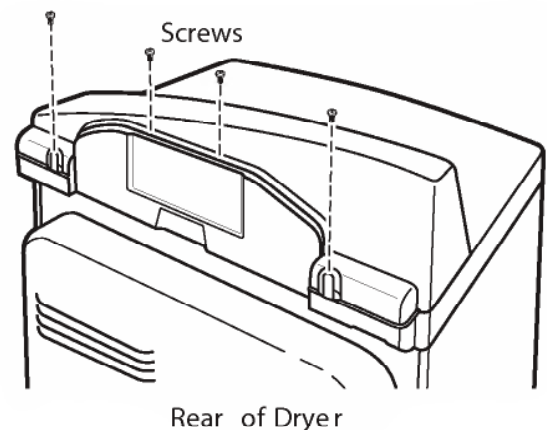

## Switching the Washer and Dryer Backsplashes (Cont.)

18. Attach the washer keypanel to the new backslash by replacing the four screws removed from the washer keypanel earlier.

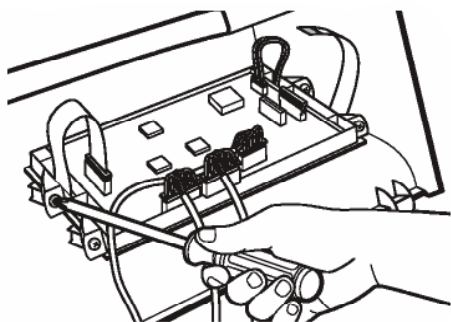

19. Connect the washer keypanel to the new backslash by inserting the ribbon from the new backslash into the keypanel and pushing down on the connector.

**Note:** The colored end of the ribbon does not go all the way into the connector. Make sure the ribbon is not twisted before inserting into the connector.

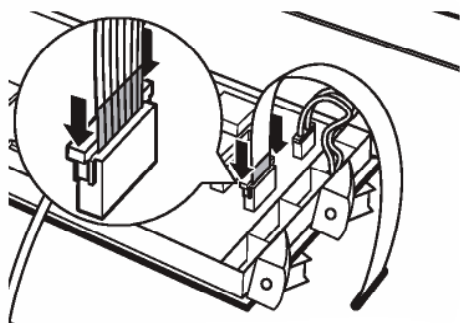

20. Place the ribbon and the wire from the rear cover under the strain relief on the new backslash

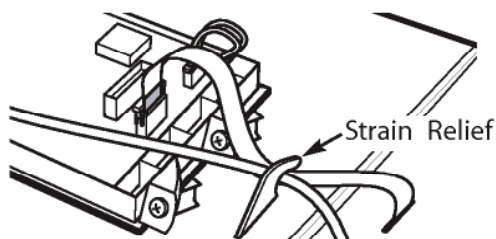

21. Insert the tabs on the bottom front of the new backslash into the slots on the washer and rotate the backslash into place.

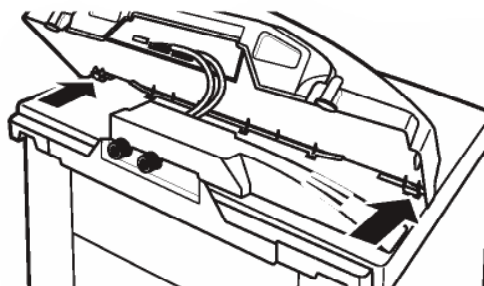

22. Secure the new backslash to the washer using the 2 screws removed earlier.

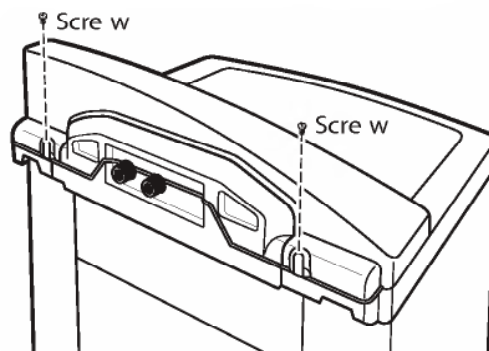

Rear of Washer

23. Reconnect house utilities.  
24. Plug the washer and dryer back in

# Reversing the Door Swing

## Overview

When viewed from the front, the dryer is shipped so the door opens from the left. Due to utility configurations or customer preferences the door can be set up to open from the right by reversing the door swing.

### To reverse the door swing:

1. Open the dryer door and remove the filler plugs opposite the hinges.

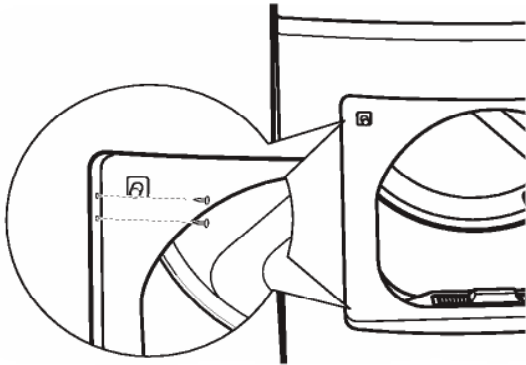

3. With the door completely open, remove the bottom screw from each hinge on the dryer face.
4. Insert the screws about halfway into the TOP holes, for each hinge, on the opposite side (where you removed the filler plugs). Apply firm pressure to get the screw started in new holes.

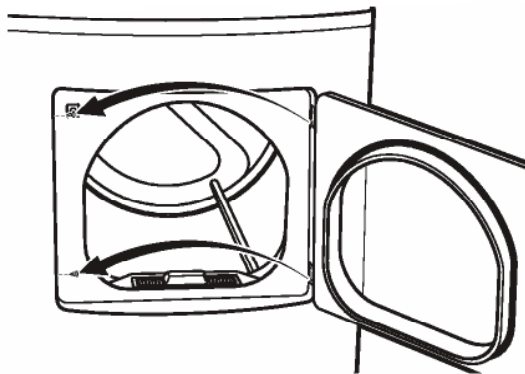

5. Loosen the top screw from each hinge on the dryer face halfway. With one hand holding the top of the door and the other hand holding the bottom, remove the door from the dryer by lifting it UP and OUT.

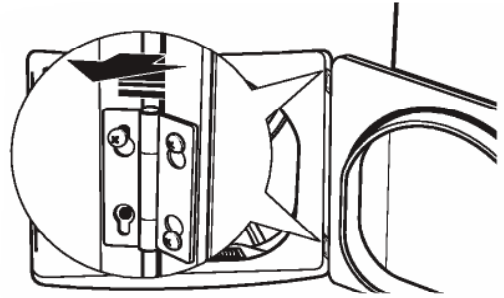

6. Remove the screws holding the handle and the two spacers.

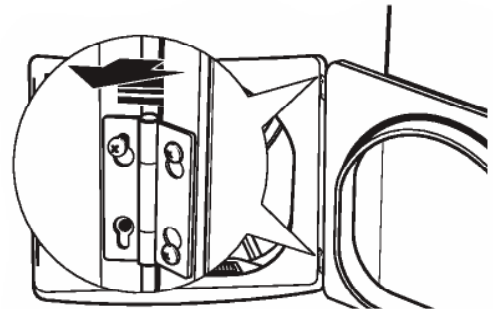

7. Remove the door catch and filler plate.
8. Install the door catch and filler plate on opposite sides of the door.

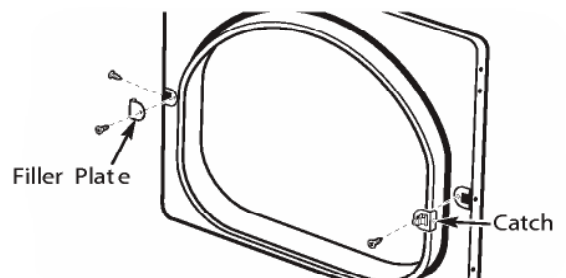

## Reversing the Door Swing (Cont.)

9. Install the handle on the opposite side of the door.

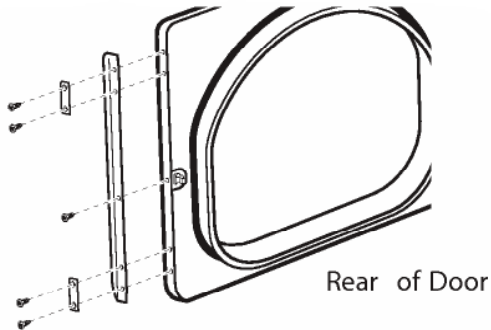

10. Remove the hinges from the door and install them on the opposite side with the hinge pin toward the outside of the door.

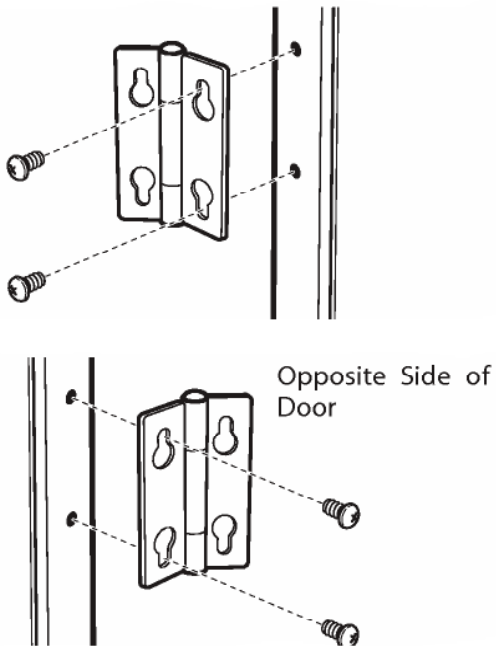

11. Insert the door on the opposite side of the opening by moving the door **IN** and **DOWN** until the top hinge and the bottom hinge are resting on the top screws.

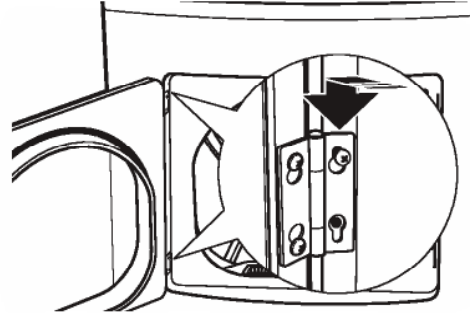

12. Remove the remaining screws from the side of the opening from which the door was removed. With these screws, secure each hinge at the bottom.

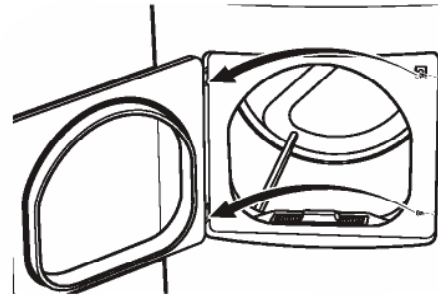

13. Tighten the two top screws of each hinge. Reinsert the plastic plugs on the side from which the door was removed.

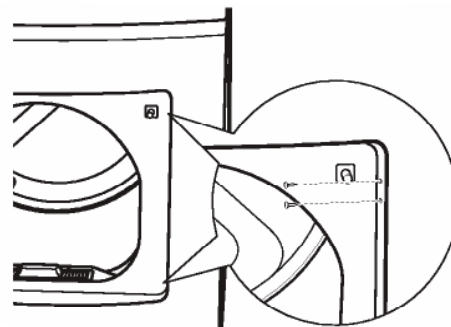

# Service Diagnostics Program

## Overview

The dryer has a self-diagnostics program to help the service technician identify and correct problems. This program tests the basic operating systems of the dryer and specifically identifies the components or systems to be checked if a problem is detected.

The dryer will not automatically identify a problem unless the self-diagnostics program has first been run. This program does not use error codes and is a part of the initial start-up process for the dryer during installation.

If a problem is found during the initial start-up process, a NOTICE message displays on the screen prompting the user to call GE service. The dryer will not operate until the problem(s) have been corrected.

After this start-up process has been completed, the owner does not have access to the self-diagnostic program. It can then only be accessed by a service technician through entering the service mode.

### To enter the service mode:

1. Press the POWER key to turn the dryer on.
  - a. If the home screen is displayed, proceed

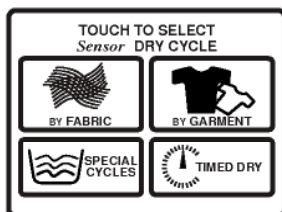

- b. If the NOTICE screen is displayed, prompting the user to call GE service, proceed to step 3.

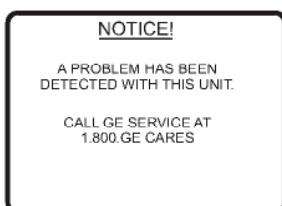

2. Press the HELP key. The troubleshooting screen is displayed.

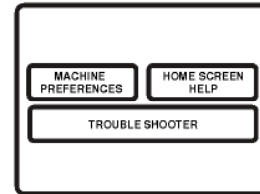

3. Press and hold HELP, MY CYCLES and BACK simultaneously for 3 seconds. The service mode diagnostics screen displays a list of problems.



4. Press EXIT. The screen prompts you to unplug the dryer before servicing.

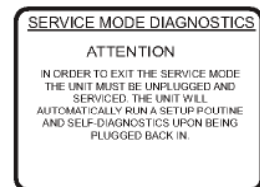

5. Disconnect power and check the listed systems and make repairs.
6. Reconnect power and press the POWER key, the dryer will prompt you to run the diagnostics program. Press OK to run the program and follow the on-screen instructions.

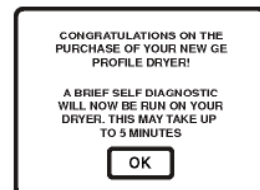

7. If a problem still exists the NOTICE screen is displayed, prompting the user to call GE service, (see step b). Repeat steps 3 through 7 until the problem has been resolved.

# Troubleshooting

For a complete list of solutions to common dryer problems, use the Troubleshooting Tips feature located by pressing the HELP button on the dryer HOME screen (see *Using the Troubleshooter*).

# Schematics

## Electric Model

**WARNING:** Disconnect electrical power before servicing.

**Caution:** Label all wires prior to disconnection. Wiring errors can cause improper and dangerous operation. Verify operation after servicing.

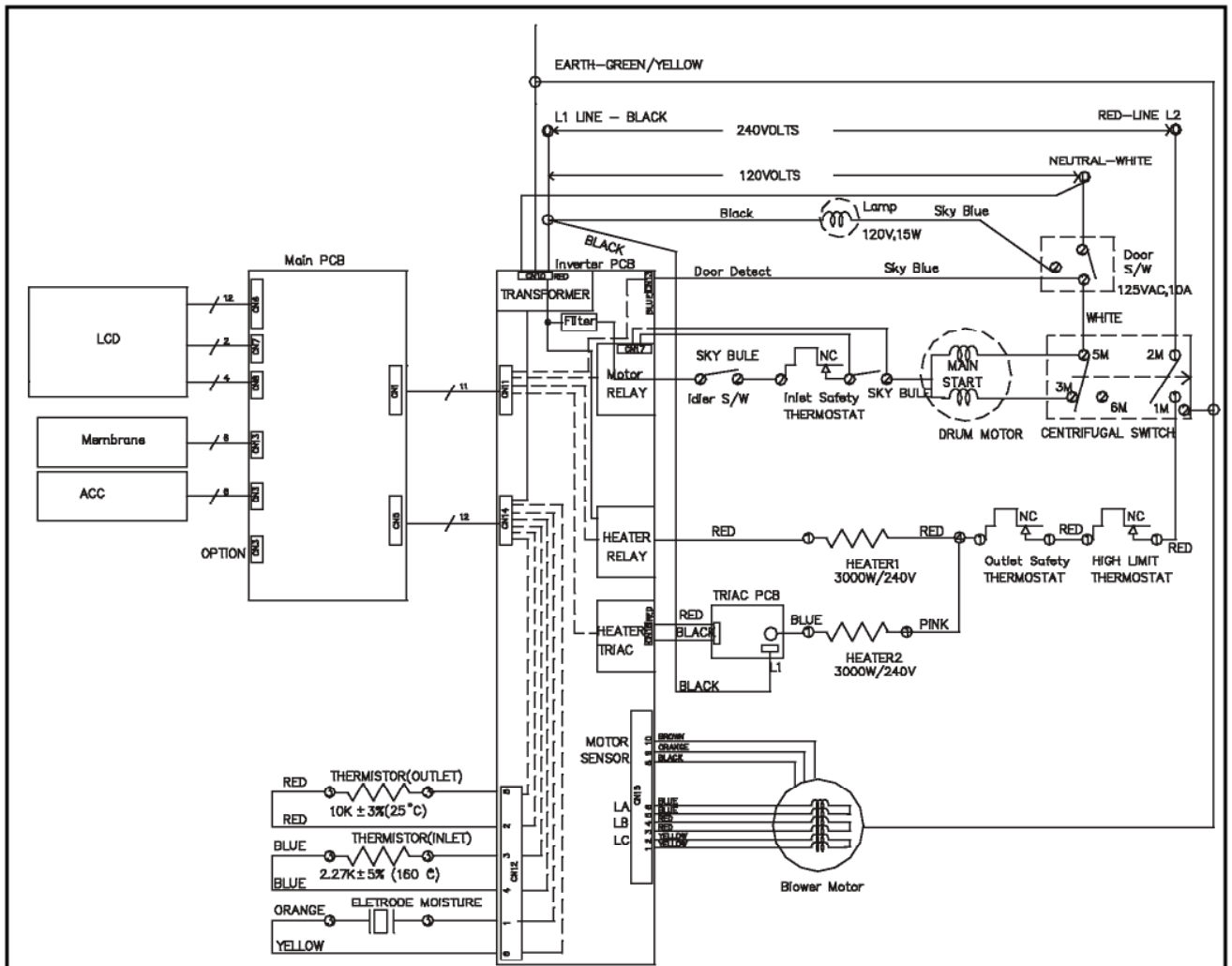

# Gas Model

**WARNING:** Disconnect electrical power before servicing.

**Caution:** Label all wires prior to disconnection. Wiring errors can cause improper and dangerous operation. Verify operation after servicing.

