

This Owner's Manual is provided and hosted by [Appliance Factory Parts](#).



LG LSN242HE Owner's Manual

[Shop genuine replacement parts for LG LSN242HE](#)



[Find Your LG Air Conditioner Parts - Select From 2328 Models](#)

----- Manual continues below -----



Room Air Conditioner

SVC MANUAL(Exploded View)

**MODEL : LSN092CE(ASNC0914DH0)/LSN092HE(ASNH091E1H0)
LSU092CE(ASUC0914DH0)/LSU092HE(ASUH091E1H0)
LSN122CE(ASNC121E1H0)/LSN122HE(ASNH121E1H0)
LSU122CE(ASUC121E1H0)/LSU122HE(ASUH121E1H0)
LSN182CE(ASNC1835DM0)/LSN182HE(ASNH1835DM0)
LSU182CE(ASUC1835DM0)/LSU182HE(ASUH1835DM0)
LSN242CE(ASNC2435DM0)/LSN242HE(ASNH2435DM0)
LSU242CE(ASUC2435DM0)/LSU242HE(ASUH2435DM0)**

CAUTION

Before Servicing the unit, read the safety precautions in General SVC manual.
Only for authorized service personnel.

1. Specification

Item	Model Name		LS*092CE (AS-C0914DH0)	LS*122CE (AS-C121E1H0)	LS*182CE (AS-C1835DM0)	LS*242CE (AS-C2435DM0)
	Unit					
Power Supply	Ø, V, Hz		1, 115V, 60	1, 115V, 60	1, 230/208, 60	1, 230/208, 60
Cooling Capacity	BTU/h		9,000	11,500	18,000/17,800	22,100/22,500
Input	W		780	1,150	1,940	2,250
Running Current	A		7	10.5	8.6/9.5	12.5/11.5
COMP. Locked Rotor AMP.	A		50	57	25*2	29+33
S.E.E.R			13	13	13	13
Air Circulation	m ³ G/min(cfm)		7.1(250)	9.3(330)	13.0(460)	15(530)
Moisture Removal	l/h(pts/hr)		1.2(2.6)	1.4(3.0)	2.5(5.3)	3.1(6.6)
Noise Level (Sound Pressure, 1m)	Indoor, High	dB(A)	36	41	41	46
	Med	dB(A)	31	36	36	41
	Low	dB(A)	28	34	35	38
	Outdoor, Max	dB(A)	48	48	55	57
Features	Temperature Control		Thermistor	themistor	Thermistor	themistor
	Air Deflection		4-way	4-way	4-way	4-way
	Steps, Fan/Cool		3/3	3/3/3	3/3	3/3/3
	Air Deflection Control(up&down)		Auto	auto	Auto	auto
	Air Deflection Control(left&right)		Auto	auto	Auto	auto
	Remocon Type		Wireless LCD	Wireless LCD	Wireless LCD	Wireless LCD
	Setting Temperature Range, Cooling Mode		64~86°F	64~86°F	64~86°F	64~86°F
	Temperature Increment		2°F(1°C)	2°F(1°C)	2°F(1°C)	2°F(1°C)
	Auto Operation(electronic control)		Yes	Yes	Yes	Yes
	Self Diagnosis		Yes	Yes	Yes	Yes
	Timer		24hr , On/Off	24hr , on/off	24hr , On/Off	24hr , on/off
	Sleep Operation		Yes	Yes	Yes	Yes
	Healthy Dehumidification Mode		Yes	Yes	Yes	Yes
	Restart Delay	minutes	3	3	3	3
Refrigerant(R-410a) Charge	g(oz)		600(21.1)	930(32.8)	850(30.0)	1750(61.7)
Power cord	AWG#:P*mm ²		14:3*2.5	14:3*2.5	14:3*2.5	12:3*2.5
Fuse of breaker Capacity	A		15	20	20	30
Connecting Cable	AWG#:P*mm ²		18:4*0.75	18:4*0.75	18:4*0.75	18:4*0.75
Connecting Tube (Ø, Socket Flare)	Liquid Side	mm(in)	6.35(1/4)	6.35(1/4)	6.35(1/4)	6.35(1/4)
	Gas Side	mm(in)	9.52(3/8)	12.7(1/2)	12.7(1/2)	15.88(5/8)
	Length, std	m(ft)	7.5(25)	7.5(25)	7.5(25)	7.5(25)
Additional Drain Hose(outer Dia.)	mm(in)		15.5(5/8)	15.5(5/8)	15.5(5/8)	15.5(5/8)
Dimensions (WxHxD)	Indoor	mm	840*270*153	895*282*165	1090*300*178	1090*300*178
		in	33-1/16*10-5/8*6-1/32	35-1/4*11-1/8*6-1/2	42-15/16*11-13/16*7-1/32	42-15/16*11-13/16*7-1/32
	Outdoor	mm	770*541*244	770*541*244	871*655*320	871*800*320
		in	30-5/16*21-5/16*9-5/18	30-5/16*21-5/16*9-5/18	34-5/16*25-13/16*12-5/8	34-5/16*31-1/2*12-5/8
Net Weight	Indoor	Kg(lbs)	7.0(15.4)	9.3(20.5)	13.0(28.6)	13(28.6)
	Outdoor	Kg(lbs)	30(66.1)	33(72.8)	68.1(149.9)	77(169.6)
Gross Weight	Indoor	Kg(lbs)	8.2(18.0)	10.5(23.1)	16.0(35.3)	16.0(35.3)
	Outdoor	Kg(lbs)	33.3(73.4)	33.3(73.4)	71.1(156.5)	82.5(181.6)

* Design and specifications subject to change without prior notice for product improvement.

Items		Unit	LS*092HE (AS-H091E1H0)	LS*122HE (AS-H121E1H0)	LS*182HE (AS-H1835DM0)	LS*242HE (AS-H2435DM0)
Power Supply		ø, V, Hz	1, 115V, 60	1, 115V, 60	1, 230/208, 60	1, 230/208, 60
Cooling Capacity		BTU/h	9,800	11,500	19,000/19,500	22,100/22,500
Heating Capacity		BTU/h	9,800	11,500	19,000/19,500	22,100/22,500
Input	Cooling	W	980	1,150	2,250	2,250
	Heating	W	980	1,150	2,700	2,700
Running Current	Cooling	A	9.5	10.5	12.5/11.5	12.5/11.5
	Heating	A	9.5	10.5	12.5/11.5	12.5/11.5
COMP. Locked Rotor AMP.	Cooling	A	57	57	29+33	29+33
	Heating	A	57	57	29+33	29+33
S.E.E.R			13	13	13	13
H.S.P.E			7.8	7.8	7.8	7.8
Air Circulation		m ³ /min(cfm)	9.3(330)	9.3(330)	15(530)	15(530)
Moisture Removal		l/h(pts/hr)	1.4(3.0)	1.4(3.0)	3.1(6.6)	3.1(6.6)
Noise Level (Sound Pressure, 1m)	Indoor, High	dB(A)	41	41	46	46
	Med	dB(A)	36	36	41	41
	Low	dB(A)	34	34	38	38
	Outdoor, Max	dB(A)	48	48	57	57
Features	Temperature Control		themistor	themistor	themistor	themistor
	Air Deflection		4-way	4-way	4-way	4-way
	Steps, Fan/Cool/Heat		3/3/3	3/3/3	3/3/3	3/3/3
	Airflow Direction Control(up&down)		auto	auto	auto	auto
	Airflow Direction Control(left&right)		auto	auto	auto	auto
	Remocon Type		Wireless LCD	Wireless LCD	Wireless LCD	Wireless LCD
	Setting Temperature Range, Cooling Mode		64~86°F	64~86°F	64~86°F	64~86°F
	Heating Mode		60~86°F	60~86°F	60~86°F	60~86°F
	Temperature Increment		2°F(1°C)	2°F(1°C)	2°F(1°C)	2°F(1°C)
	Auto Operation(electronic control)		Yes	Yes	Yes	Yes
	Self Diagnosis		Yes	Yes	Yes	Yes
	Timer		24hr, on/off	24hr, on/off	24hr, on/off	24hr, on/off
	Sleep Operation		Yes	Yes	Yes	Yes
	Healthy Dehumidification Mode		Yes	Yes	Yes	Yes
	Restart Delay	minutes	3	3	3	3
	Defrost Control		Yes	Yes	Yes	Yes
Hot Start		Yes	Yes	Yes	Yes	
Refrigerant(R410A) Charge		g(oz)	930(32.8)	930(32.8)	1750(61.7)	1750(61.7)
Power cord		AWG #: P*mm ²	14:3*2.5	14:3*2.5	12:3*2.5	12:3*2.5
Fuse or breaker Capacity		A	20	20	30	30
Connecting Cable		AWG #: P*mm ²	18:4*0.75	18:4*0.75	18:4*0.75	18:4*0.75
Connecting Tube (ø. Socket Flare)	Liquid Side	mm(in)	6.35(1/4)	6.35(1/4)	6.35(1/4)	6.35(1/4)
	Gas Side	mm(in)	12.7(1/2)	12.7(1/2)	15.88(5/8)	15.88(5/8)
	Length, std	m(ft)	7.62(25)	7.62(25)	7.62(25)	7.62(25)
Additional Drain Hose(Outer Dia.)		mm(in)	15.5(5/8)	15.5(5/8)	15.5(5/8)	15.5(5/8)
Dimensions (WxHxD)	Indoor	mm	895*282*165	895*282*165	1090*300*178	1090*300*178
		in	35-1/4*11-1/8*6-1/2	35-1/4*11-1/8*6-1/2	42-15/16*11-13/16*7-1/32	42-15/16*11-13/16*7-1/32
	Outdoor	mm	770*541*244	770*541*244	871*800*320	871*800*320
		in	30-5/16*21-5/16*9-5/8	30-5/16*21-5/16*9-5/8	34-5/16*31-1/2*12-5/8	34-5/16*31-1/2*12-5/8
Net Weight	Indoor	kg(lbs)	9.3(20.5)	9.3(20.5)	13(28.6)	13(28.6)
	Outdoor	kg(lbs)	33(72.8)	33(72.8)	77(169.6)	77(169.6)
Gross Weight	Indoor	Kg(lbs)	10.5(23.1)	10.5(23.1)	16.0(35.3)	16.0(35.3)
	Outdoor	Kg(lbs)	34.3(75.7)	34.3(75.7)	82.5(181.6)	82.5(181.6)

* Design and Specifications subject to change without prior notice for product improvement.

2. Piping Diagrams

(1) Cooling Only Models

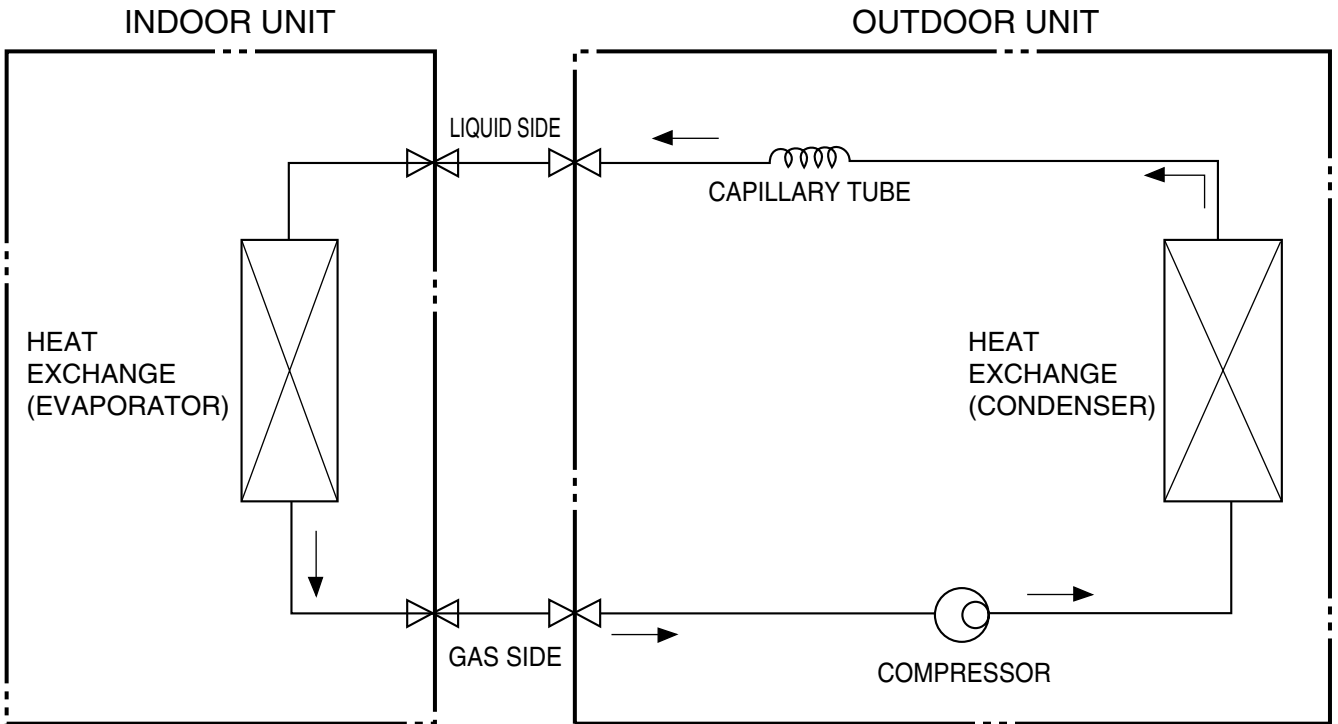

(2) Cooling & Heating Models

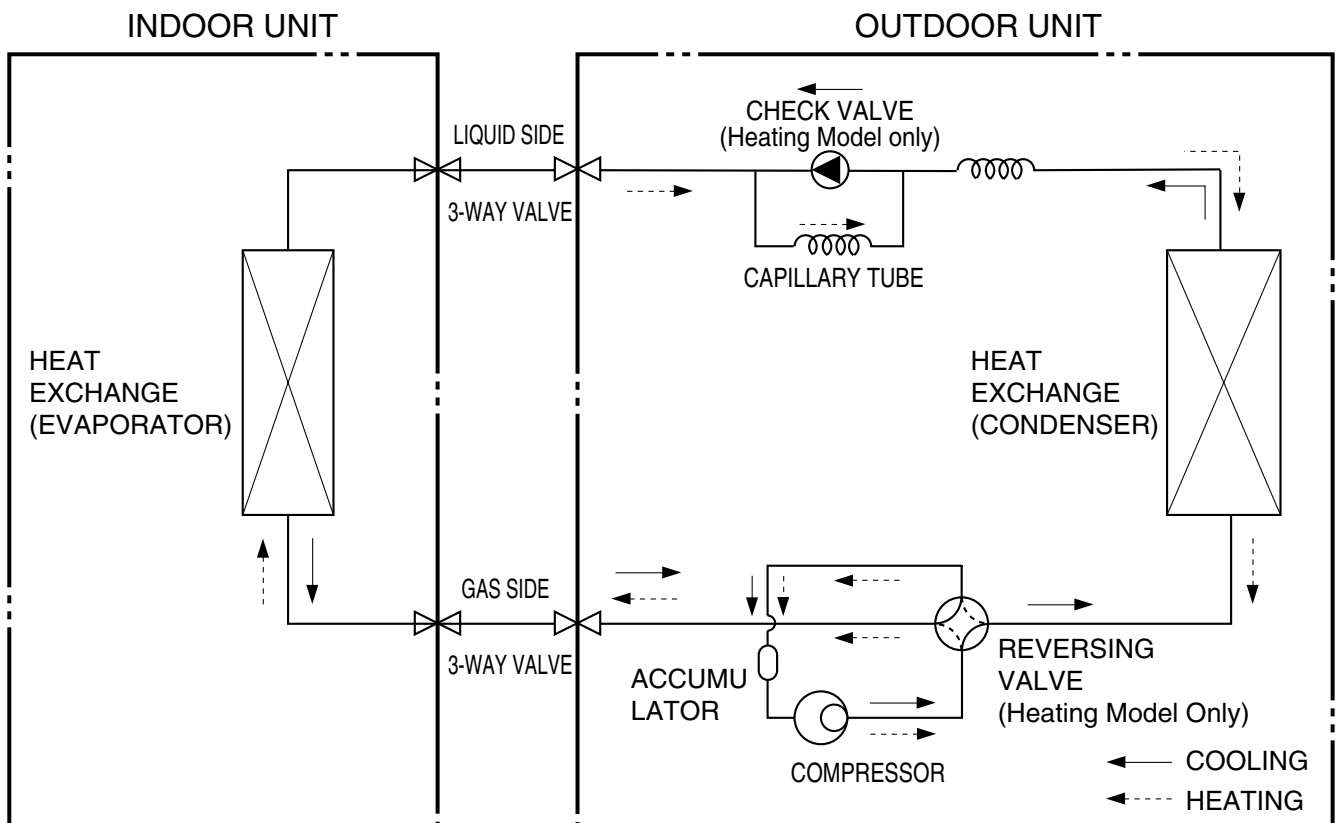

3. Wiring Diagrams

Indoor Unit

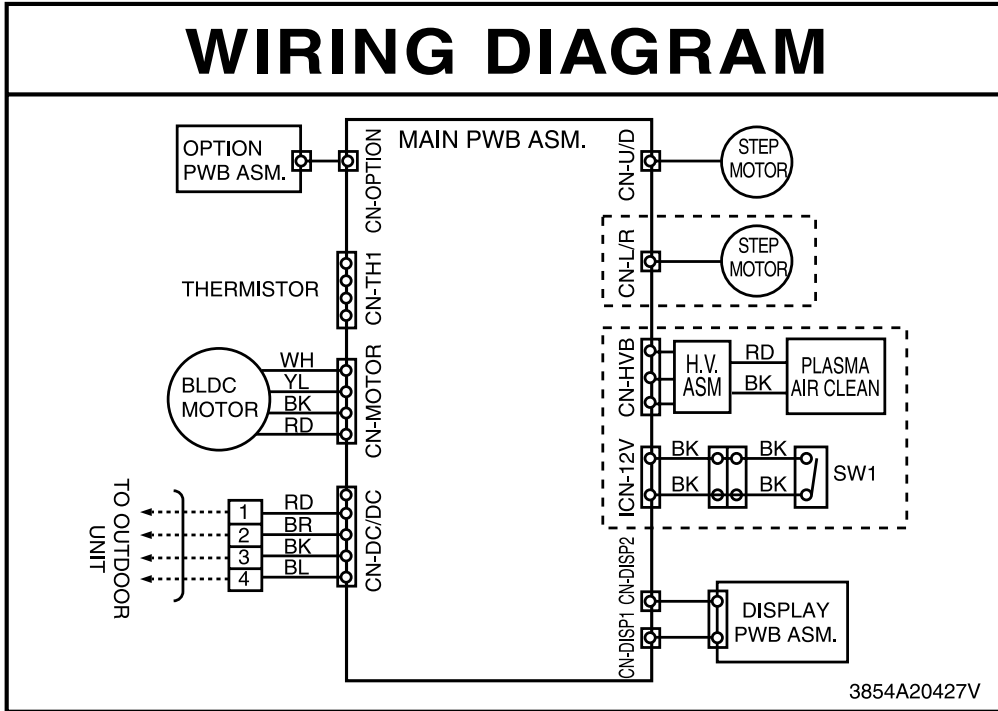

Models: 18k(C/O)

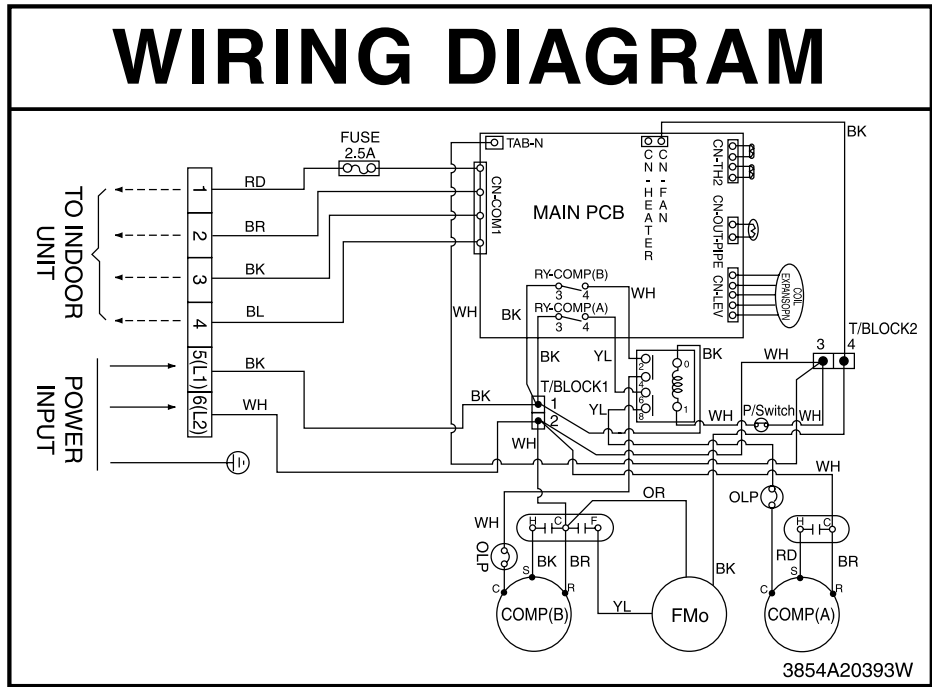

Models: 18k(H/P), 24k(C/O, H/P)

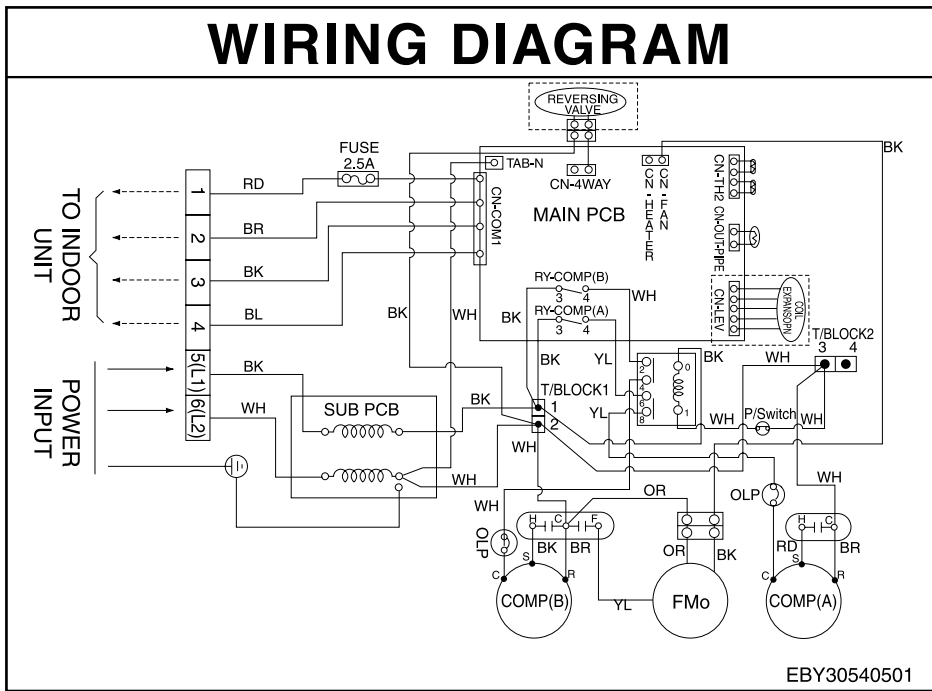

4. Exploded View

Indoor Unit



Note) * Please ensure GCSC since the replacement parts may be changed depending upon the buyer's request. Please check the correct parts in View RPL(Replacement Part List) on GCSC. (GCSC Website <http://biz.Lgservice.com>.)

Indoor Unit (ASNC0914DH0)

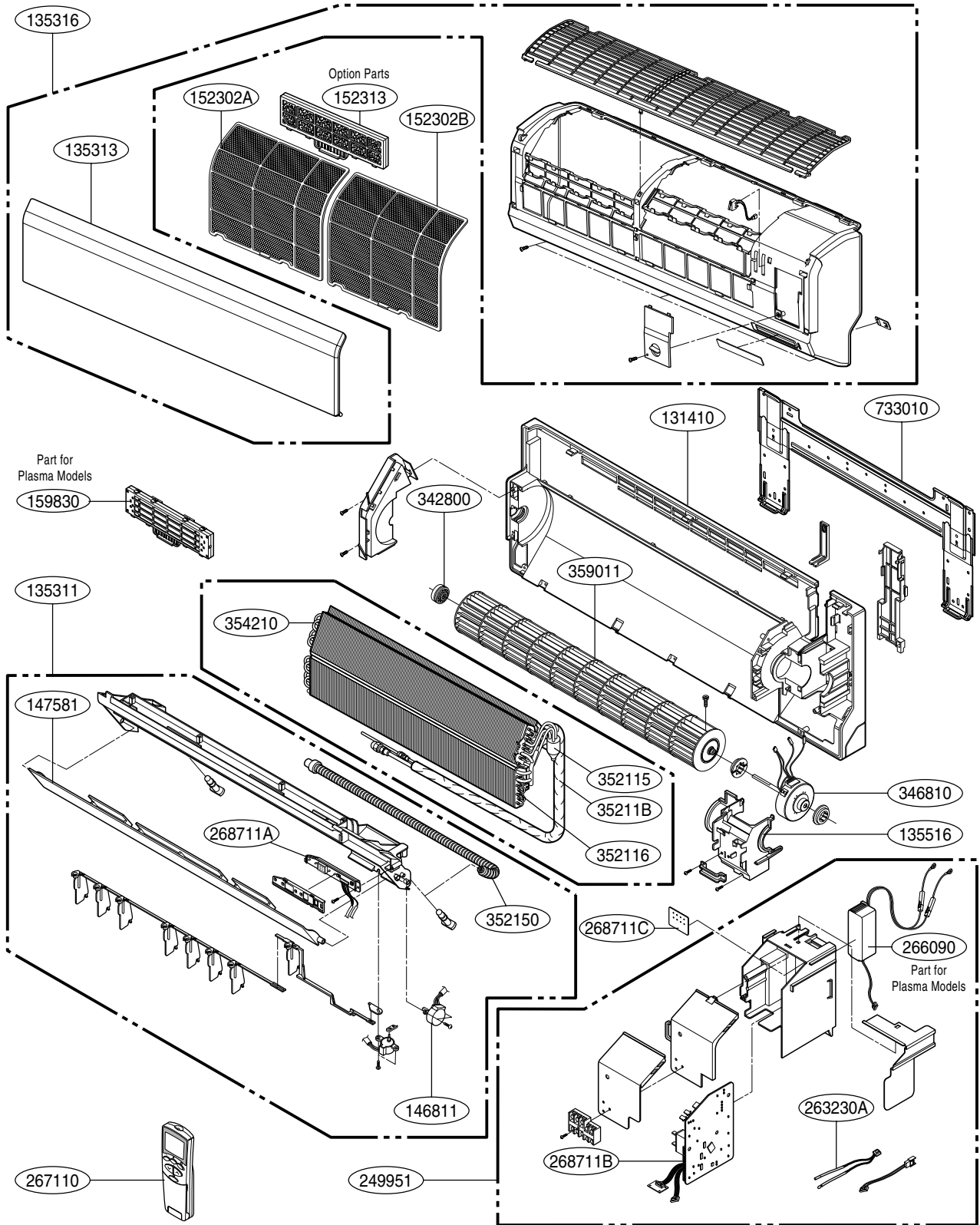

Note) * Please ensure GCSC since the replacement parts may be changed depending upon the buyer's request. Please check the correct parts in View RPL(Replacement Part List) on GCSC. (GCSC Website <http://biz.Lgservice.com>.)

Indoor Unit (ASN*1835DM0/ASN*2435DM0)

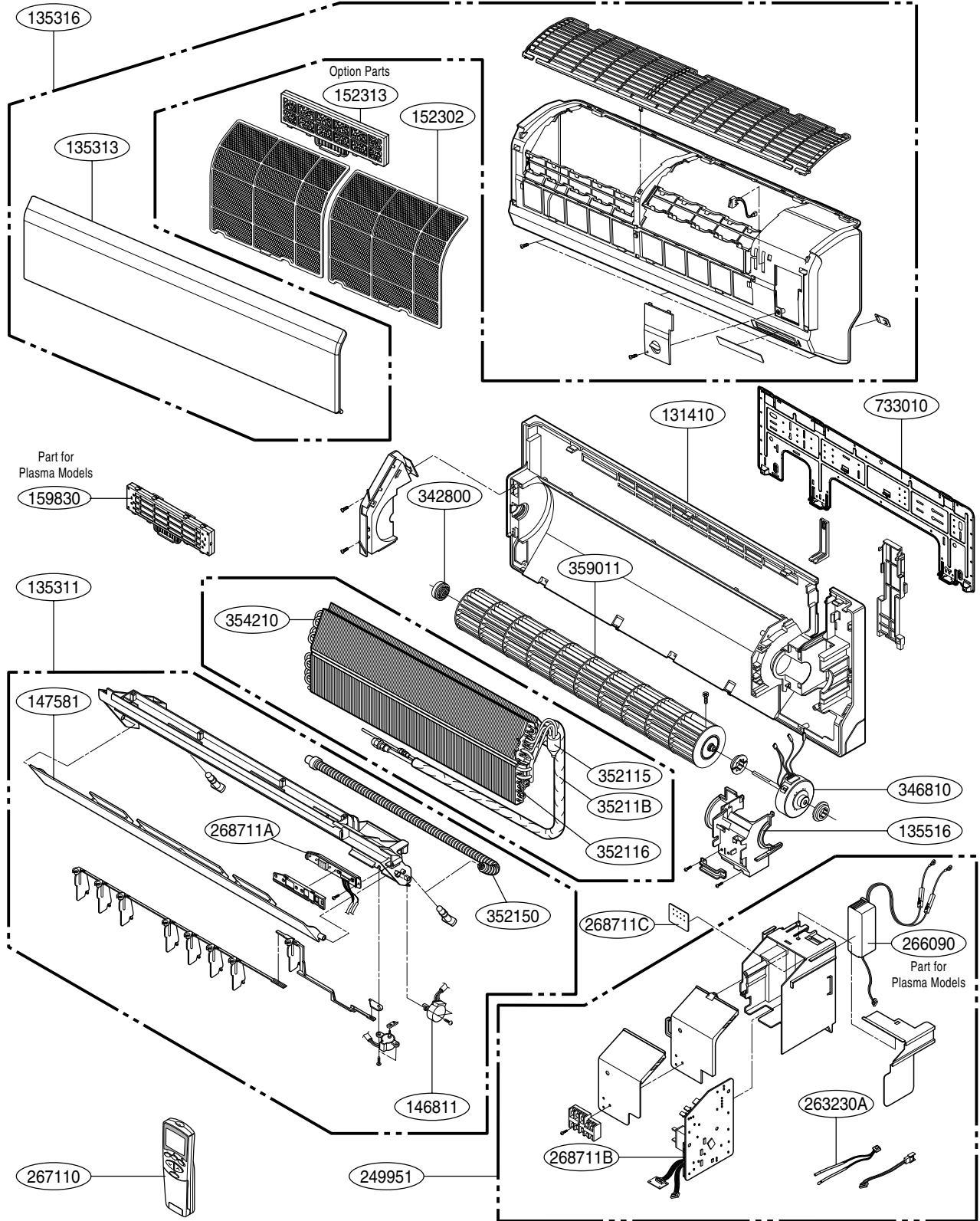

Note) * Please ensure GCSC since the replacement parts may be changed depending upon the buyer's request. Please check the correct parts in View RPL(Replacement Part List) on GCSC. (GCSC Website <http://biz.Lgservice.com>.)

Outdoor Unit
9k, 12k(C/O) Series

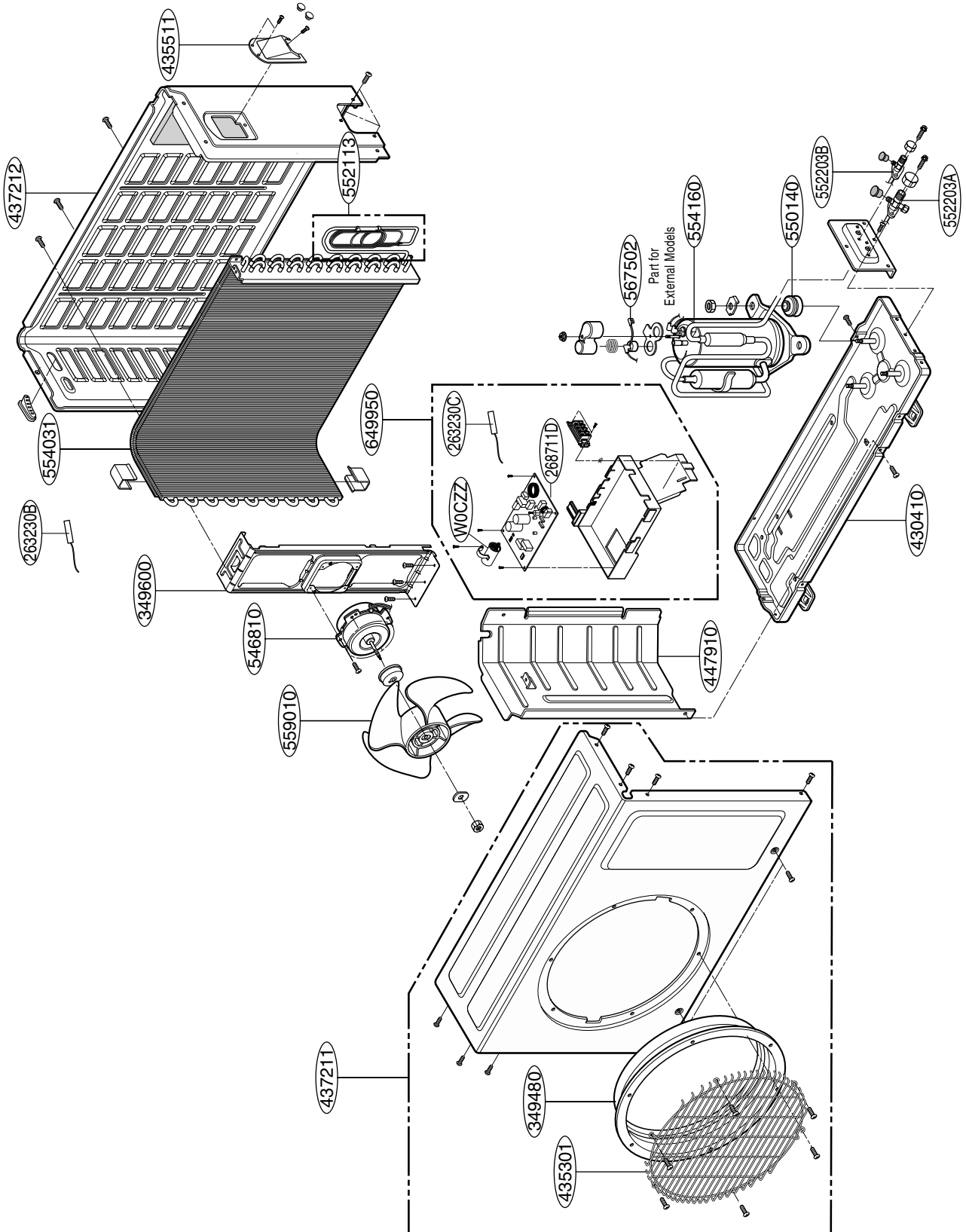

Note) * Please ensure GCSC since the replacement parts may be changed depending upon the buyer's request.
 Please check the correct parts in View RPL(Replacement Part List) on GCSC.
 (GCSC Website <http://biz.Lgservice.com>.)

Outdoor Unit 9k, 12k(H/P) Series

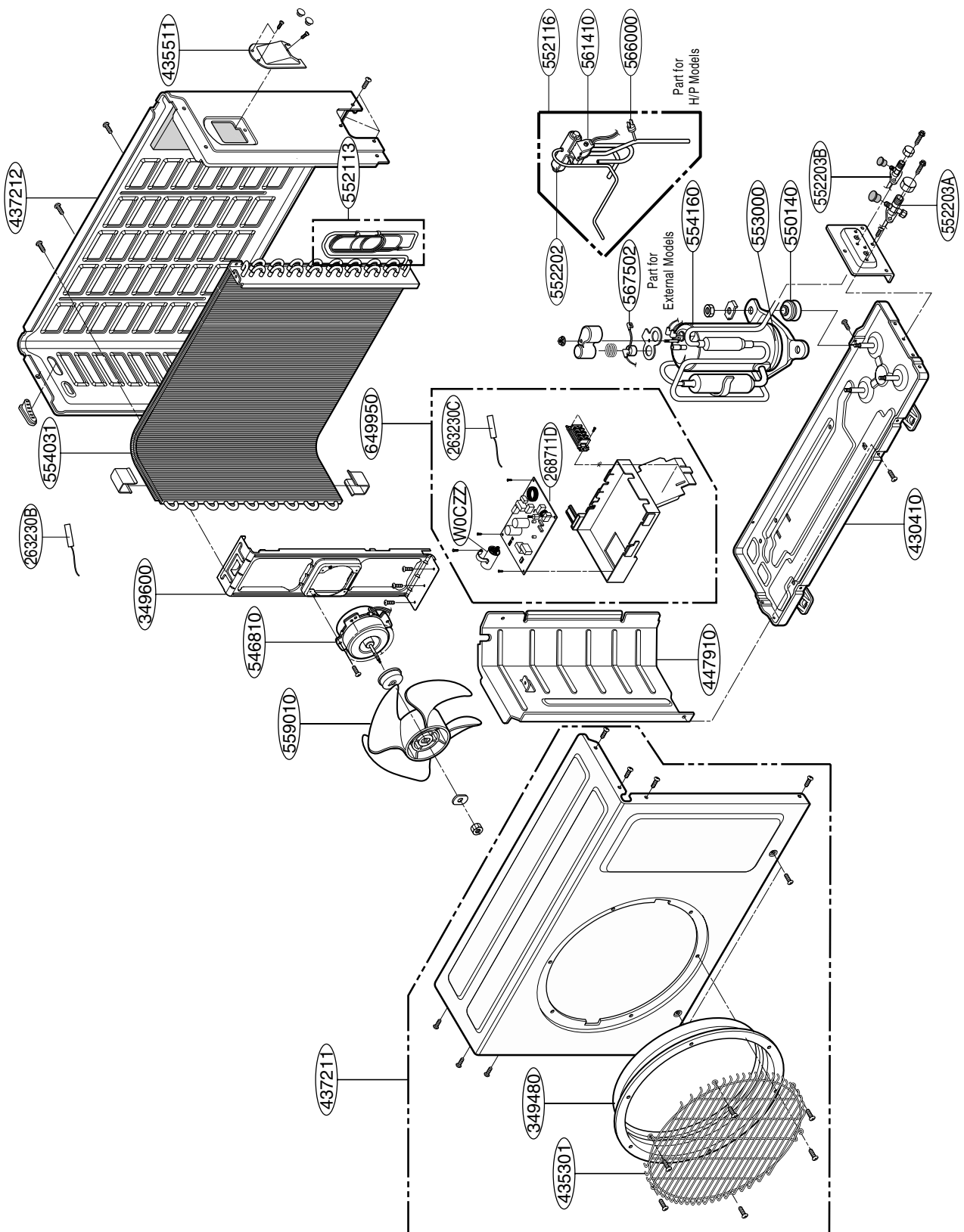

Note) * Please ensure GCSC since the replacement parts may be changed depending upon the buyer's request.
Please check the correct parts in View RPL(Replacement Part List) on GCSC.
(GCSC Website <http://biz.Lgservice.com>.)

**Outdoor Unit
18k(C/O) Series**

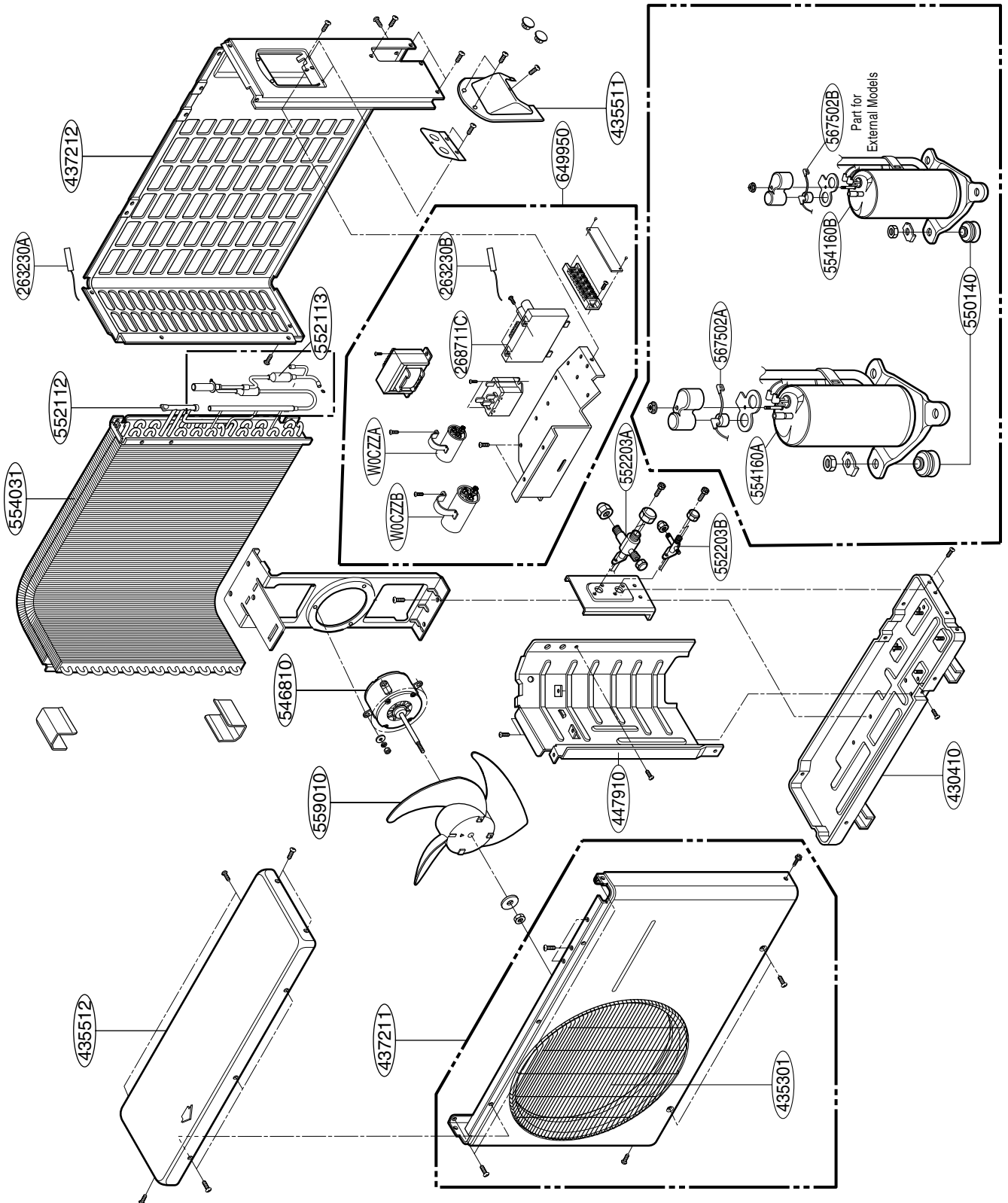

Note) * Please ensure GCSC since the replacement parts may be changed depending upon the buyer's request.
Please check the correct parts in View RPL(Replacement Part List) on GCSC.
(GCSC Website <http://biz.lgservice.com>.)

Outdoor Unit 24k(C/O) Series

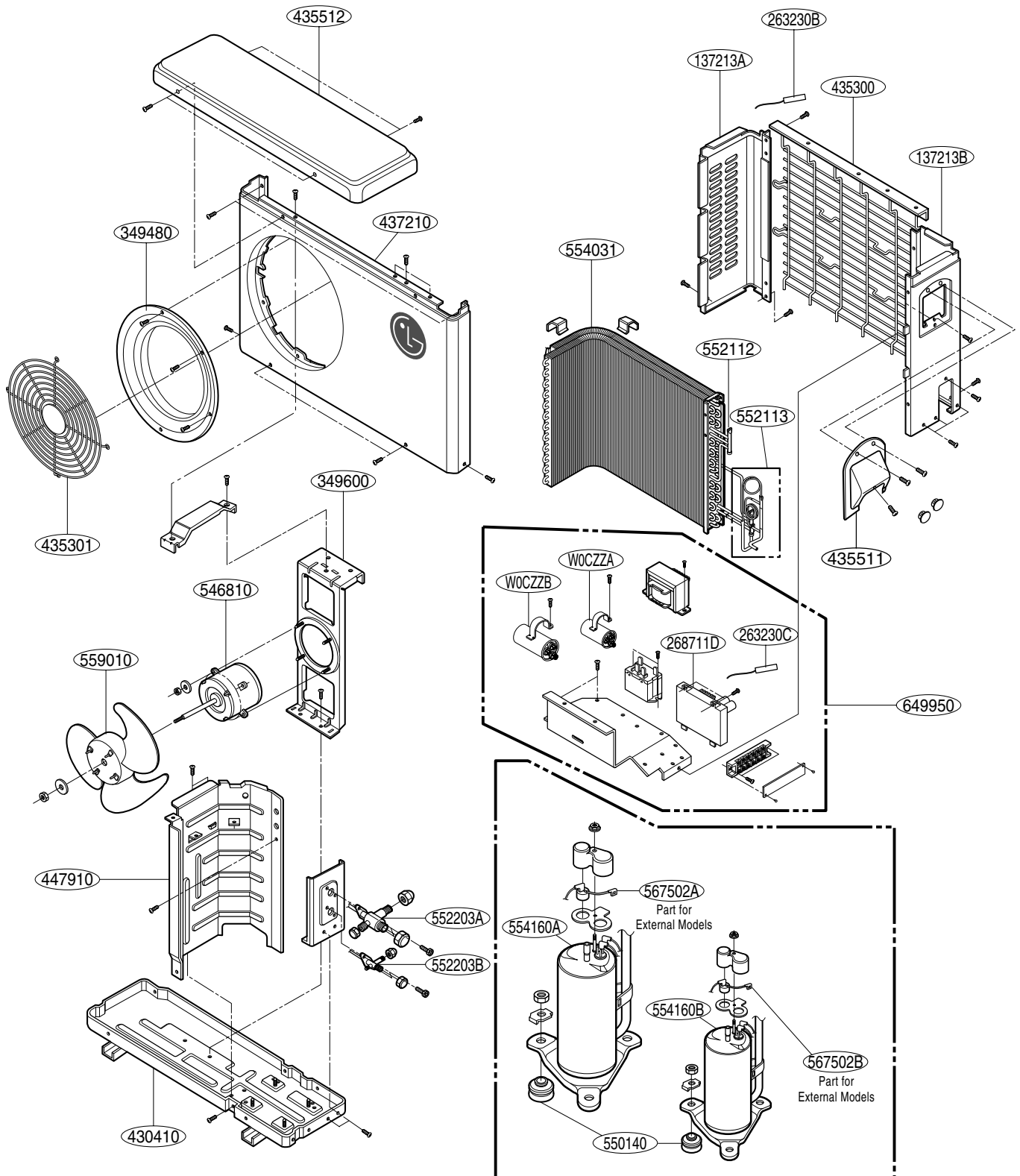

Note) * Please ensure GCSC since the replacement parts may be changed depending upon the buyer's request.
Please check the correct parts in View RPL(Replacement Part List) on GCSC.
(GCSC Website <http://biz.Lgservice.com>.)

Outdoor Unit

18k, 24k(H/P) Series

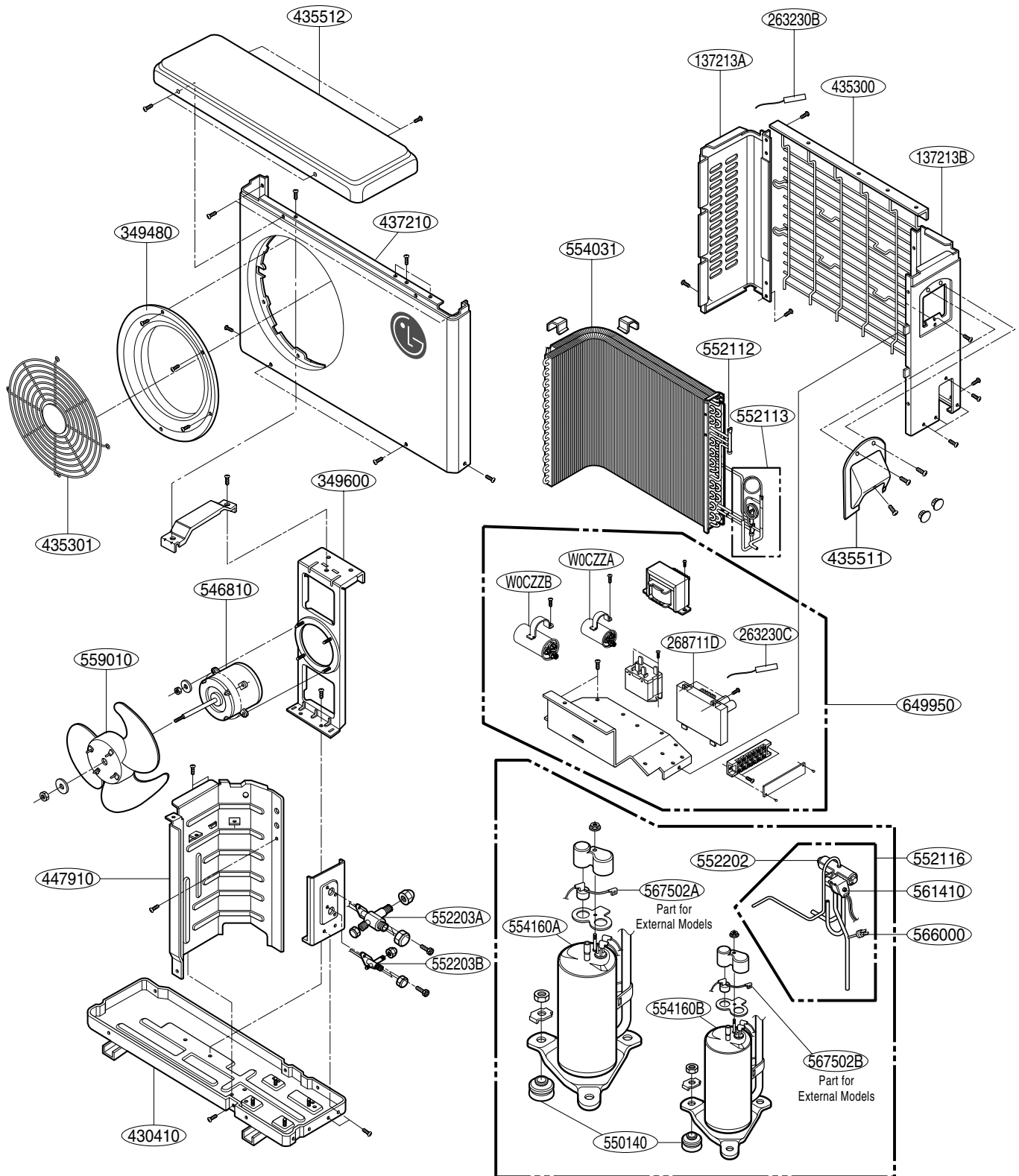

Note) * Please ensure GCSC since the replacement parts may be changed depending upon the buyer's request.
 Please check the correct parts in View RPL(Replacement Part List) on GCSC.
 (GCSC Website <http://biz.Lgservice.com>.)



P/NO : MFL42684211

MARCH, 2008