

Over The Range Microwave Oven Owner's Manual

Covering Model ACO1840A

Installer: Please leave this manual with this appliance.

Consumer: Please read and keep this manual for future reference. Keep sales receipt and/or cancelled check as proof of purchase.

Model Number

Serial Number

Date of Purchase

In our continuing effort to improve the quality and performance of our appliances, it may be necessary to make changes to the appliance without revising this guide.

If you have questions, write us (include your model number and phone number) or call:

Amana Appliances Consumer Services
Amana Appliances
2800-220th Trail
Amana, IA 52204
1-800-843-0304 U.S.A.
1-866-587-2002 Canada
Internet: <http://www.amana.com>

Contents

| | |
|-------------------------------------|-------|
| Important Safety Instructions | 2-4 |
| Features | 5-6 |
| Operation | 7-17 |
| Cooking | 18-22 |
| Maintenance..... | 23-24 |
| Recommended Utensils | 25 |
| Trouble Shooting | 26 |
| Questions and Answers | 27 |
| Warranty | 28 |

Electric Microwave

**Keep instructions for future reference.
Be sure manual stays with oven.**

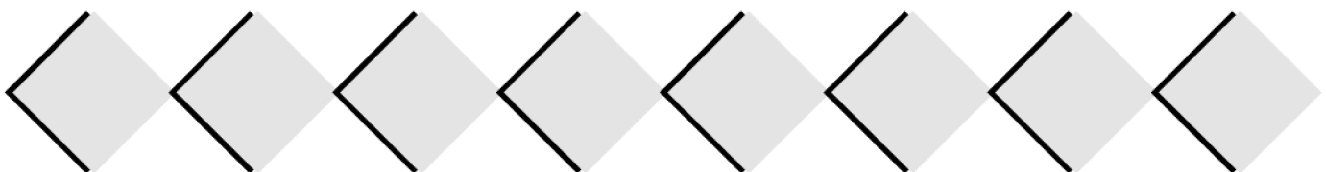

IMPORTANT SAFETY INSTRUCTIONS

What You Need to Know About Safety Instructions

Warning and Important Safety Instructions appearing in this manual are not meant to cover all possible conditions and situations that may occur. Common sense, caution, and care must be exercised when installing, maintaining, or operating microwave.

Always contact your dealer, distributor, service agent, or manufacturer about problems or conditions you do not understand.

Recognize Safety Symbols, Words, Labels

 **DANGER**

DANGER— Immediate hazards which WILL result in severe personal injury or death.

 **WARNING**

WARNING— Hazards or unsafe practices which COULD result in severe personal injury or death.

 **CAUTION**

CAUTION— Hazards or unsafe practices which COULD result in minor personal injury.

 **WARNING**

To avoid risk of electrical shock or death, this oven must be grounded and plug must not be altered.

Grounding Instructions

Oven **MUST** be grounded. Grounding reduces risk of electric shock by providing an es-



cape wire for the electric current if an electrical short occurs. This oven is equipped with a cord having a grounding wire with a grounding plug. The plug must be plugged into an outlet that is properly installed and grounded.

Consult a qualified electrician or servicer if grounding instructions are not completely understood, or if doubt exists as to whether the oven is properly grounded.

Do not use an extension cord. If the product power cord is too short, have a qualified electrician install a three-slot receptacle. This oven should be plugged into a separate 60 hertz circuit with the electrical rating as shown in specifications table. When the combination oven is on a circuit with other equipment, an increase in cooking times may be required and fuses can be blown.

Microwave operates on standard household current, 110-120V.

FEDERAL COMMUNICATIONS COMMISSION RADIO FREQUENCY INTERFERENCE STATEMENT (U.S.A. ONLY)

This equipment generates and uses ISM frequency energy and if not installed and used properly, that is in strict accordance with the manufacturer's instructions, may cause interference to radio and television reception. It has been type tested and found to comply with limits for ISM Equipment pursuant to part 18 of FCC Rules, which are designed to provide reasonable protection against such interference in a residential installation.

However, there is no guarantee that interference will not occur in a particular installation. If this equipment does cause interference to radio or television reception, which can be determined by turning the equipment off and on, the user is encouraged to try to correct the interference by one or more of the following:

- Reorient the receiving antenna of the radio or television.
- Relocate the Microwave Oven with respect to the receiver.
- Move the microwave oven away from the receiver.
- Plug the microwave oven into a different outlet so that the microwave oven and the receiver are on different branch circuits.

The manufacturer is not responsible for any radio or TV interference caused by **unauthorized modification** to this microwave oven. It is the responsibility of the user to correct such interference.

SAVE THESE INSTRUCTIONS

IMPORTANT SAFETY INSTRUCTIONS

CAUTION

When using electrical appliances, basic safety precautions should be followed to reduce the risk of burns, electric shock, fire, or injury to persons or exposure to excessive microwave energy.

1. **READ** all instructions before using oven.
2. **READ AND FOLLOW** the specific “**PRECAUTIONS TO AVOID POSSIBLE EXPOSURE TO EXCESSIVE MICROWAVE ENERGY**” on this page.
3. This oven **MUST BE GROUNDED**. Connect only to properly **GROUNDED** outlet. See installation instructions.
4. Install or locate this oven **ONLY** in accordance with the installation instructions in this manual.
5. Some products such as whole eggs and sealed containers—for example, closed glass jars—are able to explode and **SHOULD NOT** be **HEATED** in this oven.
6. Use this oven **ONLY** for its intended use as described in this manual. Do not use corrosive chemicals or vapors in this oven. This type of oven is specifically designed to heat, cook, or dry food. It is not designed for industrial or laboratory use.
7. As with any appliance, **CLOSE SUPERVISION** is necessary when used by **CHILDREN** or **INFIRM PERSONS**.
8. See door cleaning instructions in the Care and Cleaning section of manual on page 23.
9. Baby food jars shall be open when heated and contents stirred or shaken before consumption, in order to avoid burns.
10. **DO NOT** use this oven for commercial purposes. It is made for household use only.
11. **DO NOT** heat baby bottles in oven.
12. **DO NOT** operate this oven if it has a damaged cord or plug, if it is not working properly, or if it has been damaged or dropped.
13. This oven, including power cord, must be serviced **ONLY** by qualified service personnel. Special tools are required to service oven. Contact nearest authorized service facility for examination, repair, or adjustment.
14. **DO NOT** cover or block filter or other openings on oven.
15. **DO NOT** store this oven outdoors. **DO NOT** use this product near water – for example, near a kitchen sink, in a wet basement, near a swimming pool or similar locations.
16. **DO NOT** immerse cord or plug in water.
17. Keep cord **AWAY** from **HEATED** surfaces.
18. **DO NOT** let cord hang over edge of table or counter.
19. Clean the ventilating hood frequently.
20. Do not allow grease to accumulate on the hood or filters.
21. Use care when cleaning the ventilating hood filters. Corrosive cleaning agents such as lyebased oven cleaners may damage the filters.
22. When flaming foods under the hood, turn the fan on.
23. Suitable for use above both gas and electric cooking equipment 36 inches or less wide.

PRECAUTIONS TO AVOID POSSIBLE EXPOSURE TO EXCESSIVE MICROWAVE ENERGY

- A. **DO NOT** attempt to operate this oven with the door open since open door operation can result in harmful exposure to microwave energy. It is important not to defeat or tamper with the safety interlocks.
- B. **DO NOT** place any object between the oven front face and the door to allow soil or cleaner residue to accumulate on sealing surfaces.
- C. **DO NOT** operate the oven if it is damaged. It is particularly important that oven door close properly and that there is no damage to:
 1. door (bent),
 2. hinges and latches (broken or loosened),
 3. door seals and sealing surfaces.
- D. Oven should not be adjusted or repaired by anyone except properly qualified service personnel.

SAVE THESE INSTRUCTIONS

IMPORTANT SAFETY INSTRUCTIONS

Recognize this symbol as a SAFETY message

WARNING

To avoid risk of fire in the oven cavity:

- a. **DO NOT** overcook food. Carefully attend oven when paper, plastic, or other combustible materials are placed inside the oven to facilitate cooking.
- b. Remove wire twist-ties from paper or plastic bags before placing bag in oven.
- c. If materials inside the oven ignite, keep oven door **CLOSED**, turn oven off and disconnect the power cord, or shut off power at the fuse or circuit breaker panel.
- d. **DO NOT** use the cavity for storage. **DO NOT** leave paper products, cooking utensils, or food in the cavity when not in use.

WARNING

Liquids such as water, coffee, or tea are able to be overheated beyond the boiling point without appearing to be boiling due to surface tension of the liquid. Visible bubbling or boiling when the container is removed from the microwave oven is not always present. **THIS COULD RESULT IN VERY HOT LIQUIDS SUDDENLY BOILING OVER WHEN A SPOON OR OTHER UTENSIL IS INSERTED INTO THE LIQUID.** To reduce the risk of injury to persons:

1. Do not overheat the liquid.
2. Stir the liquid both before and halfway through heating it.
3. Do not use straight-sided containers with narrow necks.
4. After heating, allow the container to stand in the microwave oven for a short time before removing the container.
5. Use extreme care when inserting a spoon or other utensil into the container.

CAUTION

To avoid personal injury or property damage, observe the following:

1. Do not deep fat fry in oven. Fat could overheat and be hazardous to handle.
2. Do not cook or reheat eggs in shell or with an unbroken yolk using microwave energy. Pressure may build up and erupt. Pierce yolk with fork or knife before cooking.
3. Pierce skin of potatoes, tomatoes, and similar foods before cooking with microwave energy. When skin is pierced, steam escapes evenly.
4. Do not operate oven without load or food in oven cavity.
5. Use only popcorn in packages designed and labeled for microwave use. Popping time varies depending on oven wattage. Do not continue to heat after popping has stopped. Popcorn will scorch or burn. Do not leave oven unattended.
6. Do not use regular cooking thermometers in oven. Most cooking thermometers contain mercury and may cause an electrical arc, malfunction, or damage to oven.
7. Do not use metal utensils in oven.
8. Never use paper, plastic, or other combustible materials that are not intended for cooking.
9. When cooking with paper, plastic, or other combustible materials, follow manufacturer's recommendations on product use.
10. Do not use paper towels which contain nylon or other synthetic fibers. Heated synthetics could melt and cause paper to ignite.
11. Do not heat sealed containers or plastic bags in oven. Food or liquid could expand quickly and cause container or bag to break. Pierce or open container or bag before cooking.
12. To avoid pacemaker malfunction, consult physician or pacemaker manufacture about effects of microwave energy on pacemaker.

SAVE THESE INSTRUCTIONS

Features

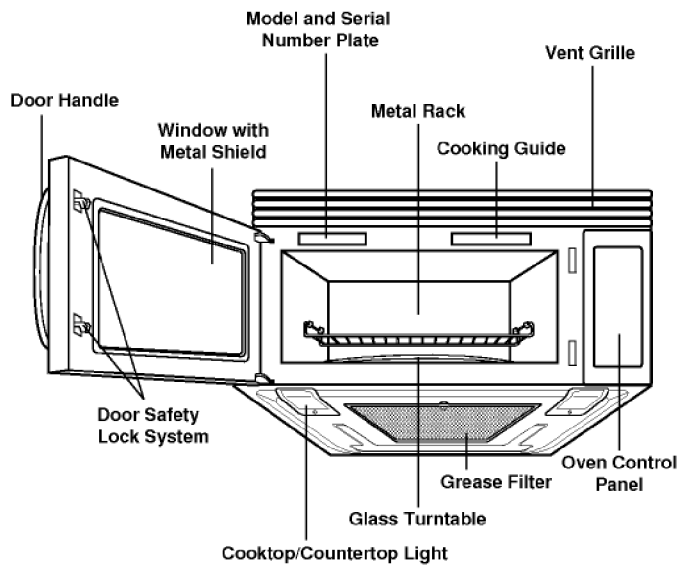

OVEN SPECIFICATIONS

| | |
|------------------|---|
| Power Supply | 120 VAC, 60 Hz |
| Input Power | 1,500 W |
| Cooking Power | 1,000 W (IEC 60705 Standard) |
| Frequency | 2,450 MHz |
| Rated Current | 13 A |
| Outer Dimensions | (WxHxD) 29 ¹⁵ / ₁₆ " x 16 ⁷ / ₁₆ " x 15 ⁵ / ₈ " |
| Cavity Volume | 1.8 Cu. Ft. |
| Net Weight | 60 lbs. |

FEATURES

NOTE: Styling and features vary by model.

1. DISPLAY: The display includes a clock and indicators to tell you time of day, cooking time settings, and cooking functions selected.

2. POPCORN: Touch this pad when popping popcorn in your microwave oven. See page 11 for more information.

3. POTATO: Touch this pad to cook from 1 to 4 potatoes. See page 11 for more information.

4. BEVERAGE: Touch this pad to reheat one or two cups of a beverage. See page 11 for more information.

5. AUTO COOK: Touch this pad to cook vegetables, rice, casseroles. See page 11 for more information.

6. PIZZA: Touch this pad to reheat 1 to 3 slices. See page 11 for more information.

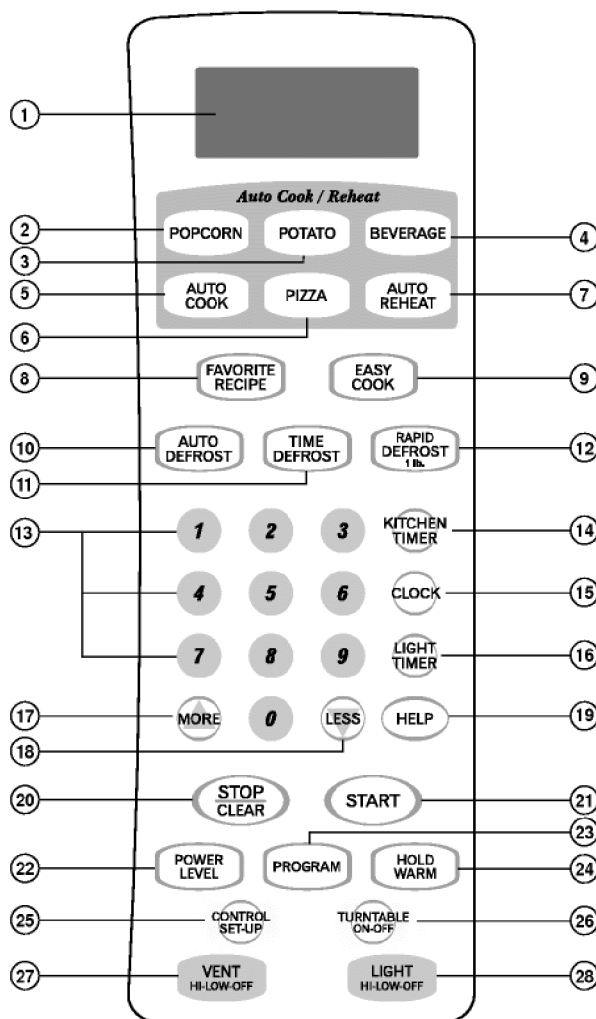

Features (cont'd)

- 7. AUTO REHEAT:** Touch this pad to reheat dinner plate, soup/sauce, casseroles, roll/muffin. See page 12 for more information.
- 8. FAVORITE RECIPE:** Touch this pad to recall one cooking instruction previously programmed into memory. See page 9 for more information.
- 9. EASY COOK:** Touch this pad to set and start quickly at 100% power level. See page 8 for more information.
- 10. AUTO DEFROST:** Meat, poultry, fish. Touch on pad to select food type and defrost food by weight. See page 13 for more information.
- 11. TIME DEFROST:** Touch this pad to defrost most other frozen foods. See page 17 for more information.
- 12. RAPID DEFROST 1lb.:** This pad provides you with the RAPID defrosting method for 1.0 pounds frozen foods. See page 17 for more information.
- 13. NUMBER:** Touch number pads to enter cooking time, power level, quantities, or weights.
- 14. KITCHEN TIMER:** Touch this pad to set the kitchen timer. See page 7 for more information.
- 15. CLOCK:** Touch this pad to enter the time of day. See page 7 for more information.
- 16. LIGHT TIMER:** Touch this pad to set the light timer. See page 8 for more information.
- 17. MORE:** Touch this pad to add ten seconds of cooking time each time you press it. See page 9 for more information.
- 18. LESS:** Touch this pad to subtract ten seconds of cooking time each time you press it. See page 9 for more information.
- 19. HELP:** Touch this pad to learn how to use each oven function. See page 7 for more information.
- 20. STOP/CLEAR:** Touch this pad to stop the oven or to clear all entries.
- 21. START:** Touch this pad to start a function. If you open the door after oven begins to cook, START again.
- 22. POWER LEVEL:** Touch this pad to select a cooking power level.
- 23. PROGRAM:** Touch this pad to set a cooking time.
- 24. HOLD WARM:** Touch this pad to keep hot, cooked foods warm in your microwave oven for up to 99 minutes 99 seconds. See page 8 for more information.
- 25. CONTROL SET-UP:** Touch this pad to change the oven's default settings for sound, clock, display speed and defrost weight. See page 7 for more information.
- 26. TURNTABLE ON-OFF:** Touch this pad to turn off the turntable. **OFF** will appear in the display. See page 7 for more information.
NOTE: This option is not available in sensor cook and defrost modes.
- 27. VENT HI-LOW-OFF:** Touch this pad to turn the fan on or off. See page 7 for more information.
- 28. LIGHT HI-LOW-OFF:** Touch this pad to turn on the cooktop/countertop light. See page 8 for more information.

Operation

LEARN ABOUT YOUR MICROWAVE OVEN

This section discusses the concepts behind microwave cooking and introduces you to the basics you need to know to operate your microwave oven. Please read this information before use.

CAUTION

- DO NOT run the oven empty.
- To avoid risk of personal injury or property damage, do not run oven empty.
- To avoid risk of personal injury or property damage, do not use stoneware, aluminum foil, metal utensils, or metal trimmed utensils in the oven.

HELP

The HELP pad displays feature information and helpful hints. Press HELP, then select a key pad.

Example: To learn about POPCORN



1. Touch **HELP** pad.



2. Touch **POPCORN** pad.

CLOCK

This oven includes a 24-hour clock.

Example: To set 8:00 AM



1. Touch **CLOCK** pad. (Press once for AM, twice for PM)



2. Enter the time by using the number key pad.



3. Touch **CLOCK** (or **START**) pad.

KITCHEN TIMER

You can use your microwave oven as a timer. Use the Timer for timing up to 99 minutes, 99 seconds.

Example: To time 3 minutes



1. Touch **KITCHEN TIMER** pad.



2. Enter the time by using the number key pad.



3. Touch **START** pad. When the time is over, you will hear seven beeps and **END** will display.

CONTROL SET-UP

You can change the default values for beep sound, clock, display speed and defrost weight.

See following chart for more information.

| No. | Function | No. | Result |
|-----|------------------------------|-----|--------------|
| 1 | Beep ON/OFF control | 1 | Sound ON |
| | | 2 | Sound OFF |
| 2 | Clock display control | 1 | Clock ON |
| | | 2 | Clock OFF |
| 3 | Display | 1 | Slow speed |
| | | 2 | Normal speed |
| | | 3 | Fast speed |
| 4 | Defrost weight mode selected | 1 | Lbs. |
| | | 2 | Kg. |

Example: To change defrost weight mode (from Lbs. to Kg)



1. Touch **CONTROL SET-UP** pad.



2. Touch number **4** pad.



3. Touch number **2** pad.

VENT HI LOW OFF



The VENT moves steam and other vapors from the cooking surface.

Touch VENT once for High fan speed, twice for Low fan speed, or three times to turn the fan off.

NOTE: If the temperature gets too hot around the microwave oven, the fan in the vent hood will automatically turn on at the LOW setting to cool the oven. It may stay on up to an hour to cool the oven. When this occurs, **You cannot turn the vent fan off.**

TURNTABLE ON-OFF



For best cooking results, leave the turntable on.

It can be turned off for large dishes. Press TURNTABLE ON-OFF to turn the turntable on or off.

NOTE:

- **The turntable ON-OFF feature does not operate with the DEFROST.**
- **Sometimes the turntable can become hot to touch.** Be careful touching the turntable during and after cooking.
- **Do not run the oven empty.**

Operation (cont'd)

CHILD LOCK

You may lock the control panel to prevent the microwave from being accidentally started or used by children.

The Child Lock feature is also useful when cleaning the control panel. Child Lock prevents accidental programming when wiping the control panel.

Example: To set the child lock



1. Touch **STOP/CLEAR** pad.
2. Touch and hold **0** pad more than 4 seconds. **LOCKED** will appear in the display window with two beeps.

Example: To cancel the child lock



1. Touch and hold **0** pad more than 4 seconds. **LOCKED** will disappear and you hear two beeps. At this time the oven is ready.

LIGHT HI-LOW-OFF



Touch **LIGHT** pad once for bright light, twice for night light, or three times to turn the light off.

LIGHT TIMER

You can set the **LIGHT** to turn on and off automatically at any time you want. The light comes on at the same time every day until reset.

Example: Turn on 2:00 AM, turn off 7:00 AM



1. Touch **LIGHT TIMER** pad. (Press once for AM, twice for PM.)
2. Enter the time you want the **LIGHT** to turn on.
3. Touch **LIGHT TIMER** pad again. (Press once for AM, twice for PM.)
4. Enter the time you want the **LIGHT** to turn off.
5. Touch **START** pad.

NOTE:

- To reset that time to turn on and off the **LIGHT**, repeat steps 1 to 5.

Example: To cancel the LIGHT TIMER



1. Touch **LIGHT TIMER** pad.
2. Touch **STOP/CLEAR** pad.

NOTE:

- If you want to cancel the **LIGHT TIMER** in operation, you should touch  key.

EASY COOK

A time-saving pad, this simplified control lets you quickly set and start microwave cooking without the need to touch **START** pad.

Example: To set for 2 minutes



Touch **EASY COOK** pad 4 times. The oven begins cooking and display shows time counting down.

NOTE:

- If you touch **EASY COOK**, it will add 30 seconds up to 3 minutes; after 3 minutes, every touch will add 1 minute up to 99 minutes 59 seconds.

HOLD WARM

You can keep cooked food warm in your microwave oven for up to 99 minutes 99 seconds. You can use **HOLD WARM** by itself or to follow a cooking cycle automatically.

Example: To use HOLD WARM



1. Touch **HOLD WARM** pad.



2. Touch **START** pad.

NOTES:

- **HOLD WARM** operates for up to 99 minutes 99 seconds.
- **Food cooked covered** should be covered during **HOLD WARM**.
- **Pastry items** (pies, turnovers, etc.) should be uncovered during **HOLD WARM**.
- **Complete meals** kept warm on a dinner plate can be covered during **HOLD WARM**.

To make HOLD WARM automatically follow another cycle:

- While you are programming the cooking instructions, touch HOLD WARM before touching START.
- When the last cooking cycle is over, you will hear two tones and "WARM" will appear in the oven display.
- You can set HOLD WARM to follow AUTO DEFROST, or multi-cycle cooking.

FAVORITE RECIPE

FAVORITE RECIPE lets you recall one cooking instruction previously placed in memory and begin cooking quickly.

Example: To cook for 2 minutes

1. Touch **FAVORITE RECIPE** pad.
2. Enter the cook time.
3. Touch **START** pad.

Example: To recall the favorite recipe

1. Touch **FAVORITE RECIPE** pad.
2. Touch **START** pad. When the cook time is over, you will hear four beeps and **END** will display.

MORE/LESS

By using the MORE or LESS keys, all of the preprogrammed cook and time cook features can be adjusted to cook food for a longer or shorter time.

Pressing MORE will add 10 seconds of cooking time each time you press it. Pressing LESS will subtract 10 seconds of cooking time each time you press it.

Example: To adjust the 1.75 oz. POPCORN cooking time for a longer time

1. Touch **POPCORN** pad.
2. Touch number **1** pad.
3. Touch **MORE** pad.

COOKING AT HIGH POWER LEVEL

Example: To cook food for 8 minutes 30 seconds

1. Enter the cook time.
2. Touch **START** pad. When the cook time is over, you will hear four beeps and **END** will display.

COOKING AT LOWER POWER LEVELS

HIGH power cooking does not always give you the best results with foods that need slower cooking, such as roasts, baked goods, or custards. Your oven has 10 power settings in addition to HIGH.

Example: To cook food for 7 minutes 30 seconds at 70% power

1. Enter the cook time.
2. Touch **POWER LEVEL** pad.
3. Enter the power level.

4. Touch **START** pad. When the cook time is over, you will hear four beeps and **END** will display. See cooking guide for power levels, page 10.

COOKING WITH MORE THAN ONE COOK CYCLE

For best results, some recipes call for one Power Level for a certain length of time, and another Power Level for another length of time. Your oven can be set to change from one to another automatically, for up to three cycles if the first heating cycle is defrost or the last at 0% power.

Example: To cook food for 3 minutes at 100% power and then 70% power for 7 minutes 30 seconds

1. Enter the cook time.
2. Touch **PROGRAM** pad.
3. Enter the second cook time.
4. Touch **POWER LEVEL** pad.
5. Enter the power level.
6. Touch **START** pad. When the cook time is over, you will hear four beeps and **END** will display.

Operation (cont'd)

COOKING GUIDE FOR POWER LEVELS

The 10 power levels in addition to HIGH allow you to choose the best power level for the food you are cooking. Below are listed all the power levels, examples of foods best cooked at each level, and the amount of microwave power you are using.

| POWER LEVEL | MICROWAVE OUTPUT | USE |
|-------------|------------------|--|
| 10 High | 100% | <ul style="list-style-type: none"> • Boil water. • Cook ground beef. • Make candy. • Cook fresh fruits and vegetables. • Cook fish and poultry. • Preheat browning dish. |
| 9 | 90% | <ul style="list-style-type: none"> • Reheat meat slices quickly. • Saute onions, celery, and green pepper. |
| 8 | 80% | <ul style="list-style-type: none"> • All reheating. • Cook scrambled eggs. |
| 7 | 70% | <ul style="list-style-type: none"> • Cook breads and cereal products. • Cook cheese dishes, veal. • Cook cakes, muffins, brownies, cupcakes. |
| 6 | 60% | <ul style="list-style-type: none"> • Cook pasta. |
| 5 | 50% | <ul style="list-style-type: none"> • Cook meats, whole poultry. • Cook custard. • Cook whole chicken, turkey, spare ribs, rib roast, sirloin roast. |
| 4 | 40% | <ul style="list-style-type: none"> • Cook less tender cuts of meat. • Reheat frozen convenience foods. |
| 3 | 30% | <ul style="list-style-type: none"> • Thawing meat, poultry, and seafood. • Cooking small quantities of food. • Finish cooking casserole, stew, and some sauces. |
| 2 | 20% | <ul style="list-style-type: none"> • Soften butter and cream cheese. • Heating small amounts of food. |
| 1 | 10% | <ul style="list-style-type: none"> • Soften ice cream. • Raise yeast dough. |
| 0 | | <ul style="list-style-type: none"> • Standing time. |

POPCORN

POPCORN lets you pop 1.75 oz., 3.0 oz., and 3.5 oz. bags of commercially packaged microwave popcorn. Pop only one package at a time. If you are using a microwave popcorn popper, follow manufacturer's instructions. To set your microwave oven correctly, follow this chart:

| Bag Size-ozs. | 1.75 | 3.0 | 3.5 |
|---------------|------|-----|-----|
| Touch NUMBER | 1 | 2 | 3 |

Example: To pop a 3.0 oz. bag

POPCORN

1. Touch **POPCORN** pad.

2

2. Touch number **2** pad.
When the cook time is over, you will hear four beeps and **END** will display.

POTATO

POTATO lets you cook potatoes with preset times and cook powers. You can choose from 1 to 4 potatoes.

NOTE:

- Cooking times are based on an average 9-11 ozs. potato per each.
- Before baking, pierce potato with fork several times.
- After baking, let stand for 5 minutes.

Example: To cook 2 potatoes

POTATO

1. Touch **POTATO** pad.

2

2. Touch number **2** pad.
When the cook time is over, you will hear four beeps and **END** will display.

PIZZA

PIZZA lets you reheat up to 3 slices refrigerated pizza. A slice is based on a 5 oz. slice.

Example: To reheat 1 slice of pizza

PIZZA

1. Touch **PIZZA** pad.

1

2. Touch number **1** pad.
When the cook time is over, you will hear four beeps and **END** will display.

BEVERAGE

BEVERAGE lets you heat up to 2 beverages.

NOTE:

- Reheat times based on an 8 oz. cup.
- Beverage may be very hot; remove from oven with care.

Example: To reheat one 8 oz. beverage

BEVERAGE

1. Touch **BEVERAGE** pad.

1

2. Touch number **1** pad.
When the cook time is over, you will hear four beeps and **END** will display.

AUTO COOK

AUTO COOK provides four preset categories for cooking.

Example: To cook 2 cups of rice

AUTO COOK

1. Touch **AUTO COOK** pad.

3

2. Choose food category.

| Category | Touch Pad Number |
|------------------|------------------|
| Fresh vegetable | 1 |
| Frozen vegetable | 2 |
| Rice | 3 |
| Casserole | 4 |

2

3. Enter quantity/servings

| Category | Number of cups |
|------------------|----------------|
| Fresh vegetable | 1-4 cups |
| Frozen vegetable | 1-4 cups |
| Rice | 1-2 cups |
| Casserole | 1-4 cups |

When the cook time is over, you will hear four beeps and **END** will display.

Operation (cont'd)

COOKING GUIDE FOR AUTO COOK

| CODE | CATEGORY | QUANTITY | DIRECTIONS |
|------|------------------|--|---|
| 1 | FRESH VEGETABLE | 1 cup Vegetables and 2 tbsp. water | Place in a microwavable bowl or casserole. Add water according to the quantity. Cover with plastic wrap and vent. Let stand for 5 minutes. |
| | | 2 cups Vegetables and 2 tbsp. water | |
| | | 3 cups Vegetables and 4 tbsp. water | |
| | | 4 cups Vegetables and 4 tbsp. water | |
| 2 | FROZEN VEGETABLE | 1 cup Vegetables and 2 tbsp. water | Place in a microwavable bowl or casserole. Cover with plastic wrap and vent. Add water according to the quantity. Let stand for 5 minutes. |
| | | 2 cup Vegetables and 2 tbsp. water | |
| | | 3 cup Vegetables and 4 tbsp. water | |
| | | 4 cup Vegetables and 4 tbsp. water | |
| 3 | RICE | 2 cups of long grain rice and 2¼ cups of water | In large microwavable casserole, combine water, rice, margarine and salt. Cover with microwavable lid or plastic wrap and vent. After cooking, let stand covered for 5 minutes. |
| | | 2 cups of long grain rice and 4½ cups of water | |
| 4 | CASSEROLE | 1 cup | Place in a microwavable bowl or casserole. Cover with plastic wrap and vent. |
| | | 2 cups | |
| | | 3 cups | |
| | | 4 cups | |

AUTO REHEAT

AUTO REHEAT provides four present categories for reheating.

Example: To reheat 2 servings of dinner plate



1. Touch **AUTO REHEAT** pad.

1

2. Choose food category.

| Category | Touch Pad Number |
|--------------|------------------|
| Dinner Plate | 1 |
| Soup/Sauce | 2 |
| Casserole | 3 |
| Roll/Muffin | 4 |

2

3. Enter quantity/ servings

| Category | Number of cups |
|--------------|----------------|
| Dinner Plate | 1-2 servings |
| Soup/Sauce | 1-4 cups |
| Casserole | 1-4 cups |
| Roll/Muffin | 1-4 pieces |

When the cook time is over, you will hear four beeps and **END** will display.

COOKING GUIDE FOR AUTO REHEAT

| CODE | CATEGORY | SERVING AMOUNT | DIRECTION |
|------|--------------|----------------|--|
| 1 | DINNER PLATE | 1 serving | Place on a low plate. |
| | | 2 servings | Cover with vented plastic wrap. |
| 2 | SOUP/SAUCE | 1 cup | Place in shallow microwavable casserole. |
| | | 2 cups | Cover with vented plastic wrap. |
| | | 3 cups | |
| | | 4 cups | |
| 3 | CASSEROLE | 1 cup | Place in a microwavable bowl or casserole. |
| | | 2 cups | Cover with vented plastic wrap. |
| | | 3 cups | |
| | | 4 cups | |
| 4 | ROLL/MUFFIN | 1 piece | Place on paper towel. |
| | | 2 pieces | Do not cover. |
| | | 3 pieces | |
| | | 4 pieces | |

AUTO DEFROST

Your microwave oven is preset with three defrost sequences. Using AUTO DEFROST is the best way to defrost frozen foods. The Auto Defrost Sequence Table below provides some basic guidelines for using the three defrost sequences.

Example: To defrost 1.2 lbs. of ground beef

AUTO DEFROST

1. Touch **AUTO DEFROST** pad.

1

2. Choose food category.

| Category | Touch Pad Number |
|----------|------------------|
| Meat | 1 |
| Poultry | 2 |
| Fish | 3 |

1 2

3. Enter the weight.

START

4. Touch **START** pad.

NOTE: When you touch the **START** pad. The display changes to defrost time count down. The oven will beep during the DEFROST cycle. At beep, open the door and turn food over, separate or rearrange the food. Remove any portions that have thawed. The oven will not STOP during the beep unless the door is opened.

START

5. Close the door and restart.

When the defrost time is over, you will hear four beeps and **END** will display.

NOTE: If the door is not opened, the display will resume the countdown.

Operation (cont'd)

WEIGHT CONVERSION CHART

To enter food weight in AUTO DEFROST, you must specify pounds and tenths of a pound. If the weight on the food package is in fractions of a pound, you can use the following chart to convert the weight to decimals.

| Equivalent Ounce Weight | Tenths of a Pound |
|-------------------------|-------------------------|
| 1.6 | .10 |
| 3.2 | .20 |
| 4.0 | .25 One-Quarter Pound |
| 4.8 | .30 |
| 6.4 | .40 |
| 8.0 | .50 One-Half Pound |
| 9.6 | .60 |
| 11.2 | .70 |
| 12.0 | .75 Three-Quarter Pound |
| 12.8 | .80 |
| 14.4 | .90 |
| 16.0 | 1.00 One Pound |

DEFROSTING TIPS

- When using AUTO DEFROST, the weight to be entered is the net weight in pounds and tenths of pounds (the weight of the food minus the container).
- Use AUTO DEFROST only for raw food. AUTO DEFROST gives best results when food to be thawed is a minimum of 0° F (taken directly from a true freezer). If food has been stored in a refrigerator-freezer that does not maintain a temperature of 5° F or below, always program a lower food weight (for a shorter defrosting time) to prevent cooking the food.
- If the food is stored outside the freezer for up to 20 minutes, enter a lower food weight.
- The shape of the package alters the defrosting time. Shallow rectangular packets defrost more quickly than a deep block.
- Separate pieces as they begin to defrost. Separated pieces defrost more easily.
- You can use small pieces of aluminum foil to shield foods like chicken wings, leg tips, and fish tails, but the foil must not touch the side of the oven. Foil causes arcing, which can damage the oven lining.
- Shield areas of food with small pieces of foil if they start to become warm.
- For better results, a preset standing time is included in the defrosting time.

AUTO DEFROST CHART

Meat Setting

| FOOD | SETTING | AT BEEP | SPECIAL INSTRUCTIONS |
|------------------------------|---------|--|--|
| BEEF | | | Meat of irregular shape and large, fatty cuts of meat should have the narrow or fatty areas shielded with foil at the beginning of a defrost sequence. |
| Ground Beef, Bulk | MEAT | Remove thawed portions with fork. Turn over. Return remainder to oven. | Do not defrost less than ¼ lb. Freeze in doughnut shape. |
| Ground Beef, Patties | MEAT | Separate and rearrange. | Do not defrost less than 2 oz. patties. Depress center when freezing. |
| Round Steak | MEAT | Turn over. Cover warm areas with aluminum foil. | Place on a microwavable roasting rack. |
| Tenderloin Steak | MEAT | Turn over. Cover warm areas with aluminum foil. | Place on a microwavable roasting rack. |
| Stew Beef | MEAT | Remove thawed portions with fork. Separate remainder and return to oven. | Place in a microwavable baking dish. |
| Pot Roast, Chuck Roast | MEAT | Turn over. Cover warm areas with aluminum foil. | Place on a microwavable roasting rack. |
| Rib Roast | MEAT | Turn over. Cover warm areas with aluminum foil. | Place on a microwavable roasting rack. |
| Rolled Rump Roast | MEAT | Turn over. Cover warm areas with aluminum foil. | Place on a microwavable roasting rack. |
| LAMB | | | |
| Cubes for Stew | MEAT | Remove thawed portions with fork. Return remainder to oven. | Place in a microwavable baking dish. |
| Chops (1 inch thick) | MEAT | Separate and rearrange. | Place on a microwavable roasting rack. |
| PORK | | | |
| Chops (½ inch thick) | MEAT | Separate and rearrange. | Place on a microwavable roasting rack. |
| Hot Dogs | MEAT | Separate and rearrange. | Place on a microwavable roasting rack. |
| Spareribs Country-style Ribs | MEAT | Turn over. Cover warm areas with aluminum foil. | Place on a microwavable roasting rack. |
| Sausage, Links | MEAT | Separate and rearrange. | Place on a microwavable roasting rack. |
| Sausage, Bulk | MEAT | Remove thawed portions with fork. Turn over. Return remainder to oven. | Place in a microwavable baking dish. |
| Loin Roast, Boneless | MEAT | Turn over. Cover warm areas with aluminum foil. | Place on a microwavable roasting rack. |

Operation (cont'd)

AUTO DEFROST CHART, (cont'd)

Poultry Setting

| FOOD | SETTING | AT BEEP | SPECIAL INSTRUCTIONS |
|--------------------------|---------|--|--|
| CHICKEN | | | |
| Whole (up to 6 lbs.) | POULTRY | Turn over (finish defrosting breast-side down). Cover warm areas with aluminum foil. | Place chicken breast-side up on a microwavable roast rack. Finish defrosting by immersing in cold water. Remove giblets when chicken is partially defrosted. |
| Cut-up | POULTRY | Separate pieces and rearrange. Turn over. Cover warm areas with aluminum foil. | Place on a microwavable roasting rack. Finish defrosting by immersing in cold water. |
| CORNISH HENS | | | |
| Whole | POULTRY | Turn over. Cover warm areas with aluminum foil. | Place on a microwavable roasting rack. Finish defrosting by immersing in cold water. |
| TURKEY | | | |
| Breast (under 6 lbs.) | POULTRY | Turn over. Cover warm areas with aluminum foil. | Place on a microwavable roasting rack. Finish defrosting by immersing in cold water. |

Fish Setting

| FOOD | SETTING | AT BEEP | SPECIAL INSTRUCTIONS |
|------------------|---------|--|---|
| FISH | | | |
| Fillets | FISH | Turn over. Separate fillets when partially thawed if possible. | Place in a microwavable baking dish. Carefully separate fillets under cold water. |
| Steaks | FISH | Separate and rearrange. | Place in a microwavable baking dish. Run cold water over to finish defrosting. |
| Whole | FISH | Turn over. | Place in a microwavable baking dish. Cover head and tail with foil; do not let foil touch sides of microwave. Finish defrosting by immersing in cold water. |
| SHELLFISH | | | |
| Crabmeat | FISH | Break apart. Turn over. | Place in a microwavable baking dish. |
| Lobster tails | FISH | Turn over and rearrange. | Place in a microwavable baking dish. |
| Shrimp | FISH | Separate and rearrange. | Place in a microwavable baking dish. |
| Scallops | FISH | Separate and rearrange. | Place in a microwavable baking dish. |

NOTE : Food to be defrosted must be not more than 6.0 lbs. (4.0kg)

* Available weight is 0.1~6.0 lbs. (0.1~4.0kg)

TIME DEFROST

This feature allows you to choose the time you want to defrost.

Example: To defrost for 2 minutes

1. Touch **TIME DEFROST** pad.
2. Enter the defrosting time you want.
3. Touch **START** pad. (Defrost starts)

When the defrost time is over, you will hear four beeps and **END** will display.

RAPID DEFROST 1 lb.

The RAPID DEFROST 1 lb. feature provides rapid defrosting for 1 lb. of frozen food. The oven automatically sets the defrosting time for ground beef.

Example: To defrost 1 lb. ground beef

1. Touch **RAPID DEFROST 1 lb.** pad.
2. Touch **START** pad.

NOTE: If the door is not opened, the display will resume the countdown.

TIME DEFROST CHART

| FOOD | TIME | SPECIAL INSTRUCTIONS |
|---|--|--|
| MEAT Bacon (1 lb.) Ground meat (1 lb.) Roasts | 2 - 4 minutes 4½ - 6 minutes 4½ - 6½ minutes | Turn meat over at beep. Stand for 5 minutes after defrosting. Turn meat over at beep. Stand for 5 minutes after defrosting. Turn meat over at beep. Shield warm areas with foil. Stand for 5 to 10 minutes. |
| Steaks, chops and cutlets | 4½ - 6 minutes per lb. | Same as above. |
| POULTRY Chicken, broiler- fryer cut up(2½ to 3 lbs.) Chicken, Whole(2 to 3 lbs.) | 13 - 16 minutes 15 - 18 minutes | Turn meat over at beep. Shield warm areas with foil. Stand for 20 to 30 minutes. Cover with foil. Turn meat over at beep. Shield warm areas with foil. Stand for 20 to 30 minutes. Cover with foil. |
| Cornish hen | 5 - 7 minutes per lb. | Turn meat over at beep. Shield warm areas with foil. Stand for 20 to 30 minutes. Cover with foil. |
| FISH & SEAFOOD Fillets(1 lb.) Shellfish, small pieces(1 lb.) | 4- 5½ minutes 4- 5 minutes | Place block in casserole. Turn food over and break up after beep. Stand for 5 minutes. |

USE OF THE TWO POSITION METAL RACK

The two position metal rack gives you extra space when cooking in more than one container at the same time. The metal rack can be turned upside down to accommodate different container sizes.

To use rack:

1. Place rack securely in the four plastic supports.
 - Rack **MUST NOT** touch metal walls or back of microwave oven.
2. Place equal amounts of food both ABOVE and BELOW rack.
 - Amount of food must be approximately the same to balance out cooking energy.

CAUTION

To avoid risk of property damage:

- Do not use rack to pop popcorn.
- Rack must be on the four plastic supports when used.
- Use the rack only when cooking food on two rack positions.
- Do not cook with rack on floor of the oven.

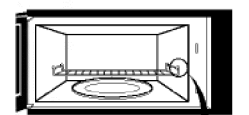
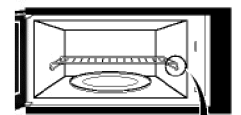

Cooking

GETTING THE BEST COOKING RESULTS

To get the best results from your microwave oven, read and follow the guidelines below.

- **Storage Temperature:** Foods taken from the freezer or refrigerator take longer to cook than the same foods at room temperature. The time for recipes in this book is based on the normal storage temperature of the food.
- **Size:** Small pieces of food cook faster than large ones, pieces similar in size and shape cook more evenly. For even cooking, reduce the power when cooking large pieces of food.
- **Natural Moisture:** Very moist foods cook more evenly because microwave energy is attracted to water molecules.
- **Stir** foods such as casseroles and vegetables from the outside to the center to distribute the heat evenly and speed cooking. Constant stirring is not necessary.
- **Turn over** foods like pork chops, baking potatoes, roasts, or whole cauliflower halfway through the

cooking time to expose all sides equally to microwave energy.

- **Place** delicate areas of foods, such as asparagus tips, toward the center of the dish.
- **Arrange** unevenly shaped foods, such as chicken pieces or salmon steaks, with the thicker, meatier parts toward the outside of the dish.
- **Shield**, with **small** pieces of aluminum foil, parts of food that may cook quickly, such as wing tips and leg ends of poultry.
- **Let It Stand:** After you remove the food from the microwave, cover food with foil or casserole lid and let it stand to finish cooking in the center and avoid overcooking the outer edges. The length of standing time depends on the density and surface area of the food.
- **Wrapping in waxed paper or paper towel:** Sandwiches and many other foods containing pre-baked bread should be wrapped prior to microwaving to prevent drying out.

FISH AND SHELLFISH

Cooking Fish and Shellfish: General Directions

- Prepare the fish for cooking.
 - Completely defrost the fish or shellfish.
 - Arrange unevenly shaped pieces with thicker parts toward the outside of the dish. Arrange shellfish in a single layer for even cooking.
 - The type of cover you use depends on how you cook. Poached fish needs a microwavable lid or vented plastic wrap.
 - Baked fish, coated fish, or fish in sauce needs to be covered lightly with waxed paper to keep the coating crisp and sauce from getting watery.
 - Always set the shortest cooking time. Fish is done when it turns opaque and the thickest part begins to flake. Shellfish is done when the shell turns from pink to red and the flesh is opaque and firm.
- The Fish and Shellfish Cooking Table below provides specific directions with Power Level and Cooking Time settings for most types of fish and shellfish.

FISH AND SHELLFISH COOKING TABLE

| FISH | POWER LEVEL | COOKING TIME | DIRECTIONS |
|-----------------|-------------|---------------|--|
| Fish fillets | HI | 3½-4½ minutes | Arrange fish in a single layer with thickest portion toward outside edge of 1½ quart microwavable baking dish. Brush with melted butter and season, if desired. Cook covered with vented plastic wrap. Let stand covered 2 minutes. If you are cooking more than 1 lb. of fish, turn the fish halfway through cooking. |
| Fish steaks | HI | 4½-5½ minutes | |
| Whole fish | 7 | 4½-6 minutes | |
| Scallops | HI | 3½-5 minutes | Arrange in a single layer. Prepare as directed above, except stir instead of turning the shellfish. |
| Shrimp, shelled | HI | 3½-5 minutes | |

APPETIZERS/SAUCES/ SOUPS

Cooking Appetizers: Tips and Techniques

Recommended

- Crisp crackers, such as melba toast, shredded wheat, and crisp rye crackers are best for microwave use. Wait until party time to add the spreads. Place a paper towel under the crackers while they cook in the microwave oven to absorb extra moisture.
- Arrange individual appetizers in a circle for even cooking.
- Stir dips to distribute heat and shorten cooking time.

Cooking Sauces: Tips and Techniques

- Use a microwavable casserole or glass measuring cup that is at least 2 or 3 times the volume of the sauce.
- Sauces made with cornstarch thicken more rapidly than those made with flour.

Cooking Soups: Tips and Techniques

- Cook soups in a microwavable dish which holds double the volume of the recipe ingredients to prevent boil-over, especially if you use cream or milk in the soup.
- Generally, cover microwaved soups with VENTED plastic wrap or a microwavable lid.
- Cover foods to retain moisture. Uncover foods to retain crispness.
- Avoid overcooking by using the minimum suggested time. Add more time, if necessary, only after checking the food.

Not Recommended

- Appetizers with a crisp coating or puff pastry are best done in a conventional oven with dry heat.
- Breaded products can be warmed in the microwave oven but will not come out crisp.
- Cook sauces made with cornstarch or flour uncovered so you may stir them 2 or 3 times during cooking for a smooth consistency.
- To adapt a conventional sauce or gravy recipe, reduce the amount of liquid slightly.
- Stirring occasionally will help blend flavors, distribute heat evenly, and may even shorten the cooking time.
- When converting a conventional soup recipe to cook in the microwave, reduce the liquid, salt, and strong seasonings.

MEAT

Cooking Meat: General Directions

- Prepare the meat for cooking.
 - Defrost completely.
 - Trim off excess fat to avoid splattering.
 - Place the meat, fat side down, on a microwavable rack in a microwavable dish.
 - Use oven cooking bag for less tender cuts of meat.
 - Arrange the meat so that thicker portions are toward the outside of the dish.
 - Cover the meat with waxed paper to prevent splattering.

- Tend the meat as it cooks.
 - Drain juices as they accumulate to reduce splattering and keep from overcooking the bottom of the meat.
 - Shield thin or bony portions with strips of foil to prevent overcooking.

NOTE: Keep the foil **at least 1 inch** from the oven walls, and do not cover more than one-third of the meat with foil at any one time.

- Let the meat stand covered with foil 10-15 minutes after you remove it from the oven. The internal temperature of the meat may rise from 5-10° F during standing time.

The Meat Cooking Table on the next page provides detailed directions, Power Level, and Cooking Time settings for most cuts of meat.

Cooking (cont'd)

MEAT COOKING TABLE

| MEAT | POWER LEVEL | COOKING TIME | DIRECTIONS |
|--|-------------|---|---|
| BEEF Hamburgers, Fresh or defrosted (4 ozs. each) 1 patty 2 patties 4 patties | HI | 1-1½ minutes 1½-2 minutes 2½-3½ minutes | Form patties with depression in center of each. Place on microwavable roasting rack. Brush with browning agent, if desired. Cover with waxed paper. Turn over halfway through cooking. Let stand covered 1 minute. |
| Sirloin tip roast (3-4 lbs.) | 5 | 8-10 minutes per pound RARE (135° F) 11-13 minutes per pound MEDIUM (155° F) | Place roast fat side down on microwavable roasting rack. Add desired seasonings and cover with waxed paper. Turn meat over halfway through cooking and shield if necessary. Remove roast from microwave oven when desired temperature is reached. Let stand covered with foil 15 minutes. (Temperature may rise about 10° F). |
| LAMB Lamb roast, rolled boneless (3-4 lbs.) | 5 | 11-12 minutes per pound RARE (135° F) 12-13 minutes per pound MEDIUM (145° F) 13-14 minutes per pound WELL (155° F) | Place roast fat side down on microwavable roasting rack. Brush lamb with marinade or desired seasonings such as rosemary, thyme or marjoram. Cover with waxed paper. Turn roast over after 15 minutes, and again after 30 minutes. Shield if necessary. Remove roast from microwave when desired temperature is reached. Let stand covered with foil 15 minutes (Temperature may rise about 10° F). |
| PORK Bacon slices 2 slices 4 slices 6 slices | HI | 1½-2 minutes 2½-3 minutes 3½-4½ minutes | Place bacon slices on microwavable roasting rack. Cover with paper towels. After cooking, let stand 1 minute. |
| Chops (5-7 ozs. each) 2 chops 4 chops | 3 | 18-20 minutes per pound 15-17 minutes per pound | Place chops in microwavable baking dish. Add desired seasonings and cover with vented plastic wrap. Cook until no longer pink or until internal temperature reaches 170° F. Turn chops over halfway through cooking. Let stand covered 5 minutes. (Temperature may rise about 10° F). |
| Loin Roast, rolled, boneless (3½- 4½ lbs.) | 3 | 25-27 minutes per pound (165° F) | Place roast in cooking bag in microwavable dish. Add seasonings and browning agent if desired. Close bag loosely with microwavable closure or string. After cooking, let stand in bag 15 minutes. (Temperature may rise about 10° F.) Internal temperature of pork should reach 170° F before serving. |
| Sausage links, Fresh or Frozen, defrosted (1-2 ozs. each) 2 links 4 links 6 links 10 links (8 oz. pkg.) | HI | 45-60 seconds 1-1½ minutes 1½-2 minutes 1¾-2 minutes | Pierce links and place on microwavable roasting rack. Cover with waxed paper or paper towel. Turn over halfway through cooking. After cooking, let stand covered 1 minute. |

POULTRY

Cooking Poultry: General Directions

- Prepare the poultry for cooking.
 - Defrost completely.
 - Arrange poultry pieces with thicker pieces at the outside edge of the baking dish. When cooking legs, arrange them like the spokes of a wheel.
 - Cover the baking dish with waxed paper to reduce splattering.
 - Use a browning agent or cook with a sauce to give a browned appearance.

- Watch the poultry as it cooks.
 - Drain and discard juices as they accumulate.
 - Shield thin or bony pieces with small strips of aluminum foil to prevent overcooking. Keep foil **at least 1 inch** from the oven walls and other pieces of foil.
- Poultry is done when it is no longer pink and the juices run clear. When done, the temperature in the thigh meat should be 180-185° F.
- Let the poultry stand after cooking covered with foil for 10 minutes.

The Poultry Cooking Table below provides detailed directions, Power Level, and Cooking Time settings for most cuts and types of poultry.

POULTRY COOKING TABLE

| POULTRY | POWER LEVEL | COOKING TIME | DIRECTIONS |
|---|-------------|----------------------------|--|
| Chicken pieces (2½-3 lbs.) | HI | 4½-5½ minutes per pound | Before cooking, wash pieces and shake the water off. Place pieces in a single layer in a microwavable baking dish with thicker pieces to the outside. Brush with butter or browning agent and seasonings if desired. Cover with waxed paper. Cook until no longer pink and juices run clear. Let stand covered 5 minutes. |
| Chicken whole (3-3½ lbs.) | HI | 12-13 minutes per pound | Before cooking, wash and shake off water. Place breast side down on a microwavable roasting rack. Brush with butter, or browning agent and seasoning if desired. Cover with waxed paper. Cook ⅓ of estimated time. Turn breast side up, brush with butter, or browning agent. Replace waxed paper. Cook ⅓ of estimated time again. Shield if necessary. Cook remaining ⅓ of estimated time or until no longer pink and juices run clear. Let stand covered with foil 10 minutes. (The temperature may rise about 10° F.) The temperature in the thigh should be 180° F-185° F when the poultry is done. |
| Cornish Hens Whole (1-1½ lbs. each) | HI | 6-7 minutes per pound | Before cooking, wash and shake the water off. Tie wings to body of hen and the legs to tail. Place hens breast side down on microwavable rack. Cover with waxed paper. Turn breast side up halfway through cooking. Shield bone ends of drumsticks with foil. Remove and discard drippings. Brush with butter or browning agent and seasonings if desired. Cook until no longer pink and juices run clear. Remove hens from microwave when they reach desired temperature. Let stand covered with foil 5 minutes. (Temperature may rise about 10° F). Temperature in breast should be 170° F before serving. |

Cooking (cont'd)

PASTA AND RICE

Microwave cooking and conventional cooking of pasta, rice, and cereal require about the same amount of time, but the microwave is a more convenient method because you can cook and serve in the same dish. There is no stirring needed and leftover pasta tastes just like fresh cooked when reheated in the microwave oven.

Cooking Pasta and Rice: Tips and Techniques

- If you are planning to use rice or pasta in a casserole, undercook it so it is still firm.
- Allow for standing time with rice, but not for pasta.
- The Pasta and Rice Cooking Tables below provide specific directions, with Power Level and cooking time settings for most common types of pasta and rice.

PASTA COOKING TABLE

| PASTA | POWER LEVEL | COOKING TIME | DIRECTIONS |
|--|-------------|-------------------------------|---|
| Spaghetti 4 cups water Add 8 ozs. spaghetti | HI 5 | 9-10 minutes 7½-8½ minutes | Combine hot tap water and salt, if desired. Use a 2-quart microwavable baking dish and cover with vented plastic wrap for spaghetti and lasagna noodles. Use microwavable lid or vented plastic wrap for macaroni and egg noodles. Cook at Power Level HI as directed in chart or until water boils. Stir in pasta; cook covered at Power Level 5 as directed in chart or until tender. Drain in a colander. |
| Macaroni 3 cups water Add 2 cups macaroni | HI 5 | 6-7 minutes 5½-6½ minutes | |
| Lasagna noodles 4 cups water Add 8 ozs. lasagna noodles | HI 5 | 7-8 minutes 11-12½ minutes | |
| Egg noodles 6 cups water Add 4 cups noodles | HI 5 | 8-10 minutes 5½-6½ minutes | |

RICE COOKING TABLE

| RICE | POWER LEVEL | COOKING TIME | DIRECTIONS |
|---|-------------|-----------------------------|---|
| Long grain 2¼ cups water Add 1 cup rice | HI 5 | 5-6 minutes 15 minutes | Combine hot tap water and salt, if desired, in 2 quart microwavable casserole. Cover with microwavable lid or vented plastic wrap. Cook as directed in chart at Power Level HI or until water boils. Stir in rice and any seasonings. Cook covered as directed in chart at Power Level 5 or until water is absorbed and rice is tender. Let stand covered 5 to 10 minutes. Fluff with fork. |
| Brown 2½ cups water Add 1 cup rice | HI 5 | 4½-5½ minutes 28 minutes | |
| Long grain and wild rice mix 2½ cups water Add 6 oz. package | HI 5 | 4-5 minutes 24 minutes | |
| Quick cooking 1 cup water Add 1 cup rice | HI | 2-3 minutes | Cook water until it boils. Stir rice into boiling water and let stand, covered 5 to 10 minutes or until water is absorbed and rice is tender. Fluff with fork. |

CARE AND CLEANING

For best performance and safety, keep the oven clean inside and outside. Take special care to keep the inner door panel and the oven front frame free of food or grease build-up.

Never use rough powder or pads.

Wipe the microwave oven inside and out, including the hood bottom cover, with a soft cloth and a warm(not hot) mild detergent solution. Then rinse and wipe dry. Use a chrome cleaner and polish on chrome, metal and aluminum surfaces. Wipe spatters immediately with a wet paper towel, especially after cooking chicken or bacon. Clean your oven weekly or more often, if needed.

METAL RACK

Wash the metal rack with a mild soap and a soft or nylon scrub brush. Dry completely. Do not use abrasive scrubbers or cleaners to clean rack.

CLEANING THE GREASE FILTER

The grease filter should be removed and cleaned often, at least once a month.

1. To remove grease filter, slide filter to the side. Pull filter downward and push to the other side. The filter will drop out.

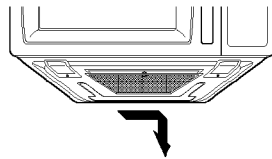

2. Wash in dishwasher or soak grease filter in hot water and a mild detergent. Rinse well and shake to dry. **Do not use ammonia or place in a dishwasher. The aluminum filter will darken.**

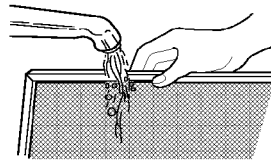

3. To reinstall the filter, slide it into the side slot, then push up and toward oven center to lock.

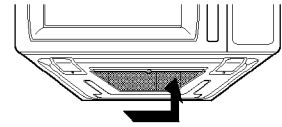

Maintenance (cont'd)

CAUTION

To avoid risk of personal injury or property damage, do not operate oven hood without filters in place.

CHARCOAL FILTER REPLACEMENT

If your oven is vented inside, the charcoal filter should be replaced every 6 to 12 months, and more often if necessary. The charcoal filter cannot be cleaned. To order a new charcoal filter, contact the Parts Department at your nearest Authorized Service Center or call 1-800-843-0304 (USA) or 1-866-587-2002 (Canada). Order Charcoal Filter kit #: MVHRK3.

1. Disconnect Power to oven.
2. Remove the two vent grille mounting screws. (2 middle screws)

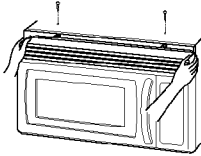

3. Tip the grille forward, then lift it out.
4. Remove old filter.

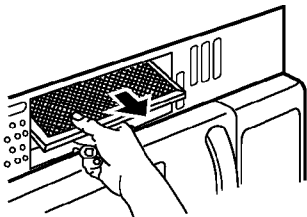

5. Slide a new charcoal filter into place. The filter should rest at the angle shown.

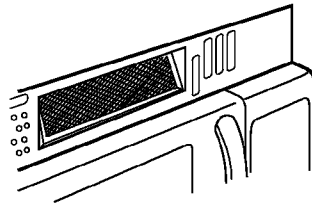

6. Slide the bottom of the grille into place. Push the top until it snaps into place. Replace the mounting screws. Turn the power back on at the main power supply and set the clock.

COOKTOP/NIGHT LIGHT REPLACEMENT

1. Unplug the oven or turn off power at the main power supply.

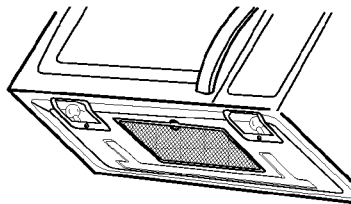

2. Remove the bulb cover mounting screws.
3. Replace bulb(s) with 30 watt appliance bulb(s).
4. Replace bulb cover, and mounting screws.
5. Turn the power back on at the main power supply.

CAUTION

To avoid personal injury or property damage, wear gloves when replacing light bulb.

OVEN LIGHT REPLACEMENT

1. Unplug oven or turn off power at the main power supply.
2. Remove the vent cover mounting screws. (2 middle screws)
3. Tip the cover forward, then lift out to remove.

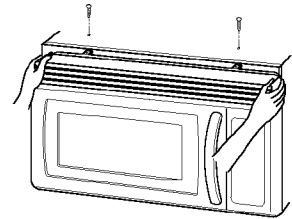

4. Remove bulb holder.

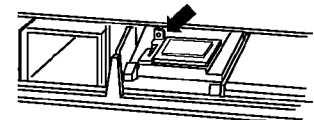

5. Lift up the bulb holder.

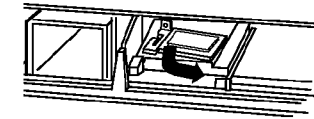

6. Replace bulb with a 30 or 40 watt appliance bulb.
7. Replace the bulb holder.
8. Slide the bottom of the vent cover into place. Push the top until it snaps into place. Replace the mounting screws. Turn the power back on at the main power supply.

Recommended Utensils

MICROWAVE UTENSIL GUIDE

| USE | DO NOT USE |
|---|---|
| <p>OVENPROOF GLASS (treated for high intensity heat): Utility dishes, loaf dishes, pie plates, cake plates, liquid measuring cups, casseroles and bowls without metallic trim.</p> <p>CHINA: Bowls, cups, serving plates and platters without metallic trim.</p> <p>PLASTIC: Plastic wrap (as a cover)-- lay the plastic wrap loosely over the dish and press it to the sides. Vent plastic wrap by turning back one edge slightly to allow excess steam to escape. The dish should be deep enough so that the plastic wrap will not touch the food. As the food heats it may melt the plastic wrap wherever the wrap touches the food. Use plastic dishes, cups, semi-rigid freezer containers and plastic bags only for short cooking time. Use these with care because the plastic may soften from the heat of the food.</p> <p>PAPER: Paper towels, waxed paper, paper napkins, and paper plates with no metallic trim or design. Look for the manufacturer's label for use in the microwave oven.</p> | <p>METAL UTENSILS: Metal shields the food from microwave energy and produces uneven cooking. Also avoid metal skewers, thermometers or foil trays. Metal utensils can cause arcing, which can damage your microwave oven.</p> <p>METAL DECORATION: Metal-trimmed or metal-banded dinnerware, casserole dishes, etc. The metal trim interferes with normal cooking and may damage the oven.</p> <p>ALUMINUM FOIL: Avoid large sheets of aluminum foil because they hinder cooking and may cause harmful arcing. Use small pieces of foil to shield poultry legs and wings. Keep ALL aluminum foil at least 1 inch from the side walls and door of the oven.</p> <p>WOOD: Wooden bowls and boards will dry out and may split or crack when you use them in the microwave oven. Baskets react in the same way.</p> <p>TIGHTLY COVERED UTENSILS: Be sure to leave openings for steam to escape from covered utensils. Pierce plastic pouches of vegetables or other food items before cooking. Tightly closed pouches could explode.</p> <p>BROWN PAPER: Avoid using brown paper bags. They absorb too much heat and could burn.</p> <p>FLAWED OR CHIPPED UTENSILS: Any utensil that is cracked, flawed, or chipped may break in the oven.</p> <p>METAL TWIST TIES: Remove metal twist ties from plastic or paper bags. They become hot and could cause a fire.</p> |

Trouble Shooting

Before Calling for Service

Check the following list to be sure a service call is necessary. Reviewing additional information on items to check may prevent an unneeded service call.

| Problem | Possible Causes |
|---|--|
| If nothing on the oven operates | <ul style="list-style-type: none"> • check for a blown circuit fuse or a tripped main circuit breaker. • check if oven is properly connected to electric circuit in house. • check that controls are set properly. |
| If the oven interior light does not work | <ul style="list-style-type: none"> • the light bulb is loose or defective. |
| If oven will not cook | <ul style="list-style-type: none"> • check that control panel was programmed correctly. • check that door is firmly closed. • check that Start Pad was touched. • check that timer wasn't started instead of a cook function. |
| If oven takes longer than normal to cook or cooks too rapidly | <ul style="list-style-type: none"> • be sure the Power Level is programmed properly. |
| If the time of day clock does not always keep correct time | <ul style="list-style-type: none"> • check that the power cord is fully inserted into the outlet receptacle. • be sure the oven is the only appliance on the electrical circuit. |
| If food cooks unevenly | <ul style="list-style-type: none"> • be sure food is evenly shaped. • be sure food is completely defrosted before cooking. • check placement of aluminum foil strips used to prevent overcooking. |
| If food is undercooked | <ul style="list-style-type: none"> • check recipe to be sure all directions (amount, time, and power levels) were correctly followed. • be sure microwave oven is on a separate circuit. • be sure food is completely defrosted before cooking. |
| If food is overcooked | <ul style="list-style-type: none"> • check recipe to be sure all directions (amount, power level, time, size of dish) were followed. |
| If arcing (sparks) occur | <ul style="list-style-type: none"> • be sure microwavable dishes were used. • be sure wire twist ties were not used. • be sure oven was not operated when empty. • make sure metal rack (if used) is properly installed on 4 supports. |
| If the Display shows a time counting down but the oven is not cooking | <ul style="list-style-type: none"> • check that door is firmly closed. • check that timer was not started instead of a cooking function. |
| Vent fan starts automatically | <ul style="list-style-type: none"> • If the temperature gets too hot around the microwave oven, the fan in the vent hood will automatically turn on at the LOW setting to cool the oven. It may stay on up to an hour to cool the oven. |

Questions and Answers

WARNING

To avoid electrical shock which can cause severe personal injury or death, do not remove outer case at any time, only an authorized servicer should remove outer case.

QUESTIONS AND ANSWERS

| Question | Answer |
|---|--|
| Can I use a rack in my microwave oven so that I may reheat or cook in two rack positions at a time? | Only use the rack that is supplied with your microwave oven. Use of any other rack can result in poor cooking performance and/or arcing and may damage your oven. Do not use the rack when sensor cooking. |
| Can I use either metal or aluminum pans in my microwave oven? | Usable metal includes aluminum foil for shielding (use small, flat pieces). Never allow metal to touch walls or door. |
| Sometimes the door of my microwave oven appears wavy. Is this normal? | This appearance is normal and does not affect the operation of your oven. |
| What are the humming noises I hear when my microwave oven is operating? | This is the sound of the transformer when the magnetron tube cycles on and off. |
| Why does the dish become hot when I microwave food in it? | As the food becomes hot it will conduct the heat to the dish. Use hot pads to remove food after cooking. Dish may not be microwave safe. |
| What does standing time mean? | Standing time means that food should be taken out of the oven and covered for additional time after cooking. This process allows the cooking to finish, saves energy, and frees the oven for other purposes. |
| Can I pop popcorn in my microwave oven? How do I get the best results? | Yes. Pop packaged microwave popcorn following manufacturer's guidelines or use the preprogrammed Popcorn pad. Do not use regular paper bags. Use the listening test by stopping the oven as soon as the popping slows to a pop every one or two seconds. Do not try to repop unpopped kernels. You can also use special microwave poppers. When using a popper, be sure to follow manufacturer's directions. Do not pop popcorn in glass utensils. |
| Why does steam come out of the air exhaust vent? | Steam is normally produced during cooking. The microwave oven has been designed to vent this steam out the top vent. |

Warranty

FULL ONE Year

Amana will repair or replace, including related labor, any part which proves defective as to workmanship or materials.

Limited Warranty

After one year from the date of original retail purchase, Amana will provide a free part, as listed below, to replace any part that fails due to a defect in materials or workmanship. The owner will be responsible for paying all other costs including mileage and transportation.

Second through Fifth Year

Amana will provide replacement magnetron, touch pad and microprocessor, part and labor, which proves defective as to workmanship or materials.

What is not covered by these warranties

- Replacement of household fuses, resetting of circuit breakers, or correction to household wiring or plumbing.
- Normal product maintenance and cleaning, including light bulbs.
- Products with original serial numbers removed, altered, or not readily determined.
- Products purchased for commercial, industrial, rental, or leased use.
- Products located outside of the United States or Canada.
- Premium service charges, if the servicer is requested to perform service in addition to normal service or outside normal service hours or area.
- Adjustments after the first year.
- Repairs resulting from the following:
 - Improper installation, exhaust system, or maintenance.
 - Any modification, alteration, or adjustment not authorized by Amana.
 - Accident, misuse, abuse, fire, flood, or acts of nature.
 - Connections to improper electrical current, voltage supply, or gas supply.
 - Use of improper pans, containers, or accessories that cause damage to the product.
- Travel.

If you need service

- Call the dealer from whom your appliance was purchased or call Amana Appliances Consumer Services at 1-800-843-0304, USA or 1-866-587-2002 Canada to locate an authorized servicer.
- Be sure to retain proof of purchase to verify warranty status. Refer to WARRANTY for further information on owner's responsibilities for warranty service.
- If the dealer or service company cannot resolve the problem, write to Amana Appliances Consumer Services, Amana Appliances, 2800-220th Trail, Amana, Iowa, 52204 or call **1-800-843-0304**, USA or **1-866-587-2002** Canada.

NOTE: When writing or calling about a service problem, please include the following information:

- a. Your name, address and telephone number;
- b. Model number and serial number;
- c. Name and address of your dealer or servicer;
- d. A clear description of the problem you are having;
- e. Proof of purchase (sales receipt).

- User's guides, service manuals and parts information are available from Amana Appliances Consumer Services .

IN NO EVENT SHALL MAYTAG BE LIABLE FOR INCIDENTAL OR CONSEQUENTIAL DAMAGES.

This warranty gives you specific legal rights, and you may have others which vary from state to state. For example, some states do not allow the exclusion or limitation of incidental or consequential damages, so this exclusion may not apply to you.