

This Owner's Manual is provided and hosted by [Appliance Factory Parts](#).



LG AG1AH23BWF Owner's Manual

[Shop genuine replacement parts for LG AG1AH23BWF](#)



[Find Your LG Air Conditioner Parts - Select From 2328 Models](#)

----- Manual continues below -----

Functions

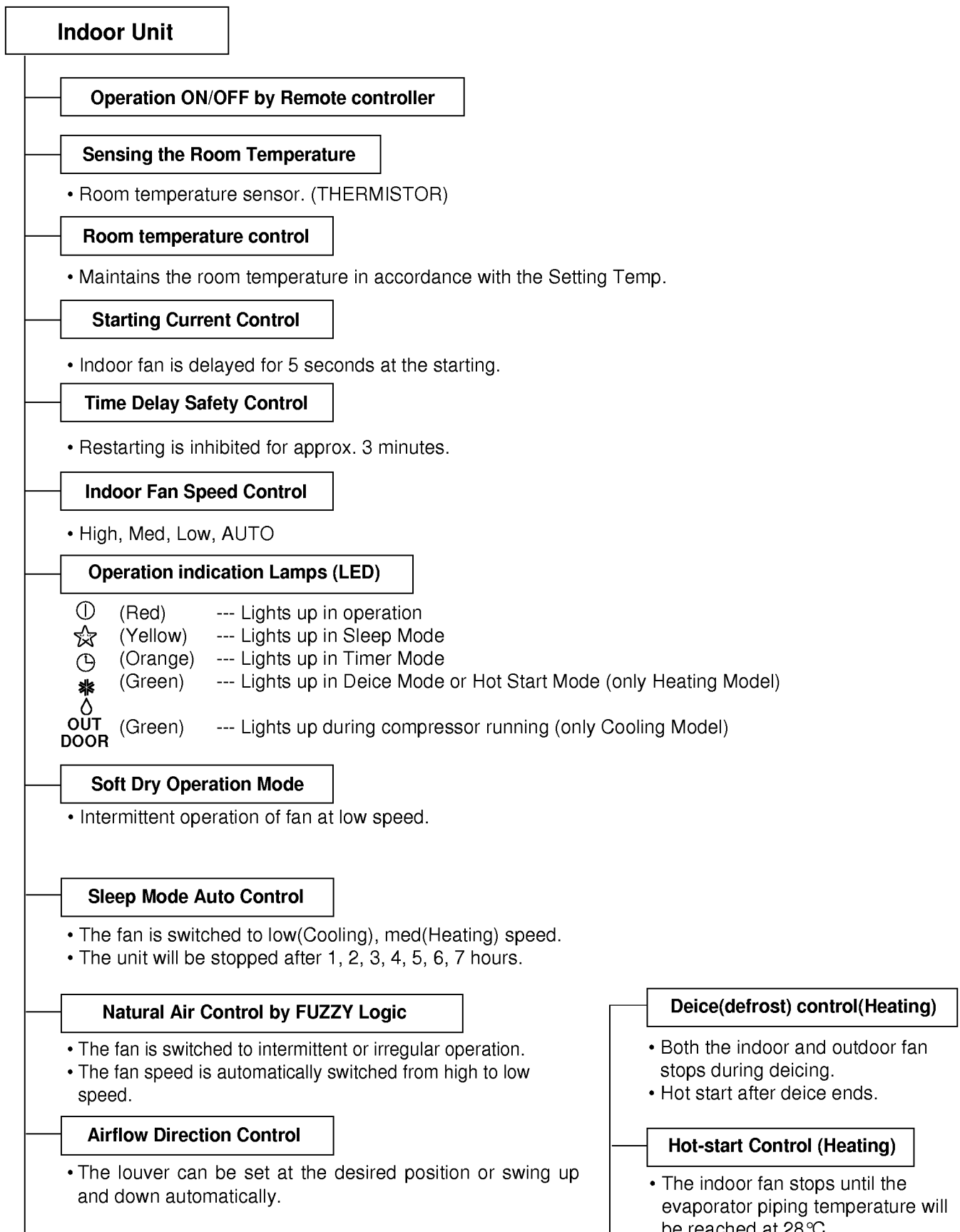

Remote Controller

Operation ON/OFF



Operation Mode Selection

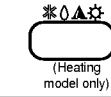

Cooling Operation Mode. (*) Auto Operation Mode. (▲)
 Soft Dry Operation Mode. (◊) Heating Operation Mode. (✱)

Fan Speed Selection



(Low) (Med) (High) AUTO (AUTO WIND)

Room, Temperature Display



: High: 39°C ↔ LOW : 11°C

Temperature Setting

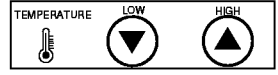

Cooling — Down to 18°C
 Up to 30°C,

Heating — Down to 16°C
 Up to 30°C,

Setting the Time or timer



Timer Selection



: OFF, ON, OFF ↔ ON

Timer Setting



Timer Cancel



: Cancel Sleep Mode, Timer ON or Timer OFF

Sleep Operation



: 1, 2, 3, 4, 5, 6, 7, Off Timer

Airflow Direction Control



Fan Operation Mode



: Fan Operates without cooling or heating.

Reset

○ RESET

Operation Details

(1) The function of main control

1. Time delay Safety Control

- 3min... The compressor is ceased for 3minutes to balance the pressure in the refrigeration cycle. (Protection of compressor)
- 5sec... Vertical air flow direction control louvers open in 5 seconds to prevent noise between louvers and wind.
- 30sec... The 4-way valve is ceased for 30sec. to prevent the refrigerant-gas abnormal noise when the Heating operation is OFF or switched to the other operation mode while compress is off. While compressor is running, it takes 3~5 seconds to switch.

2. Airflow Direction Control

- This function is to swing the louver up and down automatically and to set it at the desired position.
- The procedure is as the following.

1st ; Press the ON/OFF Button to operate the product.

2nd ; Press the Airflow Direction Control Button to swing the louver up and down automatically.

3nd ; Reprress the Airflow Direction Control Button to set the louver as the desired position.

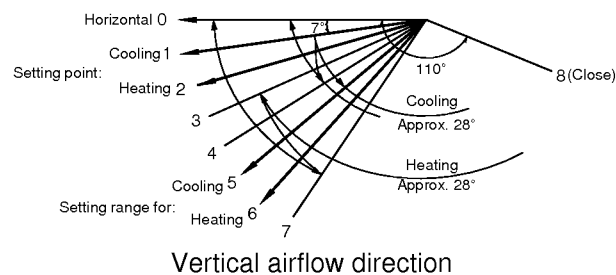

3. Cooling Mode Operation

- When selecting the Cooling(❄) Mode Operation, the unit will operate according to the setting by the remote controller and the operation diagram is as following.

Intake Air temp.					
SETTING TEMP. +0.5°C (Compressor ON)					
SETTING TEMP. -0.5°C (Compressor OFF)					
INDOOR FAN	Selecting fan speed	Low	Selecting fan speed	Low	Selecting fan speed
COMPRESSOR	ON	OFF	ON	OFF	ON

4. Cooling or Heating Mode with Sleep Mode Auto Operation

- When selecting the Cooling(❄) or the Heating(🔥) combined with the Sleep Mode Auto Operation(☆), the operation diagram is as following.

■ **Cooling Mode with the Sleep Mode**

- The setting temperature will be raised by 1°C 30 minutes later and by 2°C 1 hour later.
- The operation will be stopped after 1, 2, 3, 4, 5, 6, 7 hours.

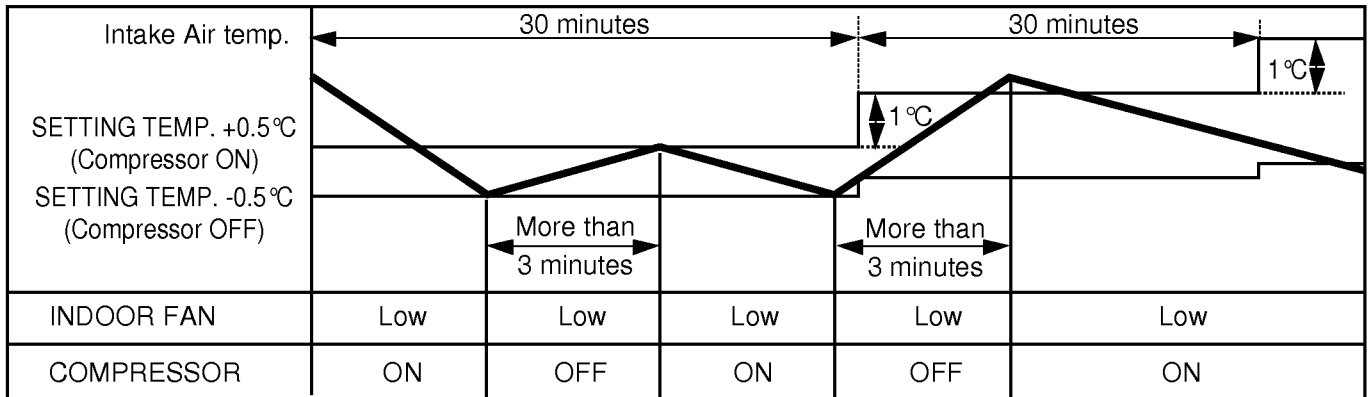

■ **Heating Mode with the Sleep Mode**

- The operation will be stopped after 1, 2, 3, 4, 5, 6, 7 hours.

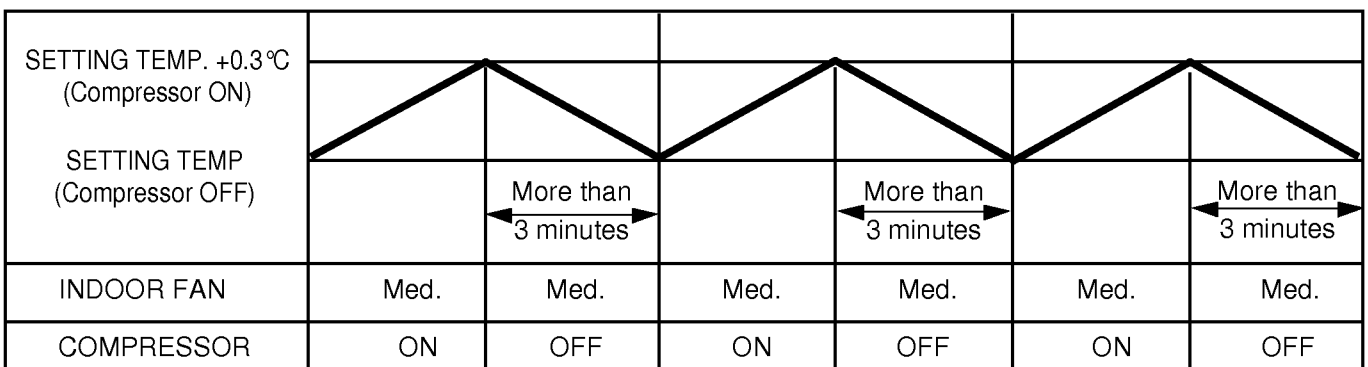

5. Auto Operation

- The operation procedure is as following. (Cooling & Heating Model)

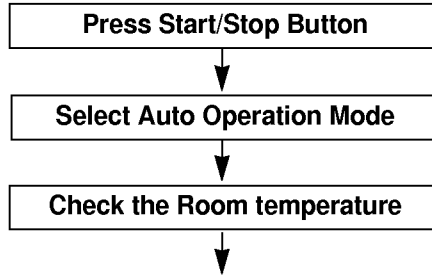

Operation mode Indoor fan speed Setting temperature				are automatically decided by Fuzzy rule.
Intake-air temperature	below 21 °C	Over 21 °C ~ below 24 °C	Over 24 °C	
Operation Mode	Heating	Soft Dry	Cooling	

* If initial mode is decided, that mode is continued without the room temperature changing.

* For cooling operation mode over 24 °C setting temperature and fan speed are same as cooling only model.

■ Auto Operation for Cooling. (Cooling only Model)

Operation Condition	Intake-air Temperature	Setting Temperature	Fan Speed	Air Direction Control
When Auto Operation initial start	Over 26 °C	25 °C	Controlled by Fuzzy logic	In this mode, when pressing the vertical air direction control. Button, louvers moves to 1/f rhythm (refer to page 17)
	Over 24 °C~below 26 °C	Intake air -1 °C		
	Over 22 °C~below 24 °C	Intake air -0.5 °C		
	Over 20 °C~below 22 °C	Intake air temperature		
	below 20 °C	20 °C		
When pressing room temperature setting button during Auto Operation	Over 20 °C~below 30 °C	Fuzzy control		
	below 20 °C	20 °C		
	over 30 °C	30 °C		

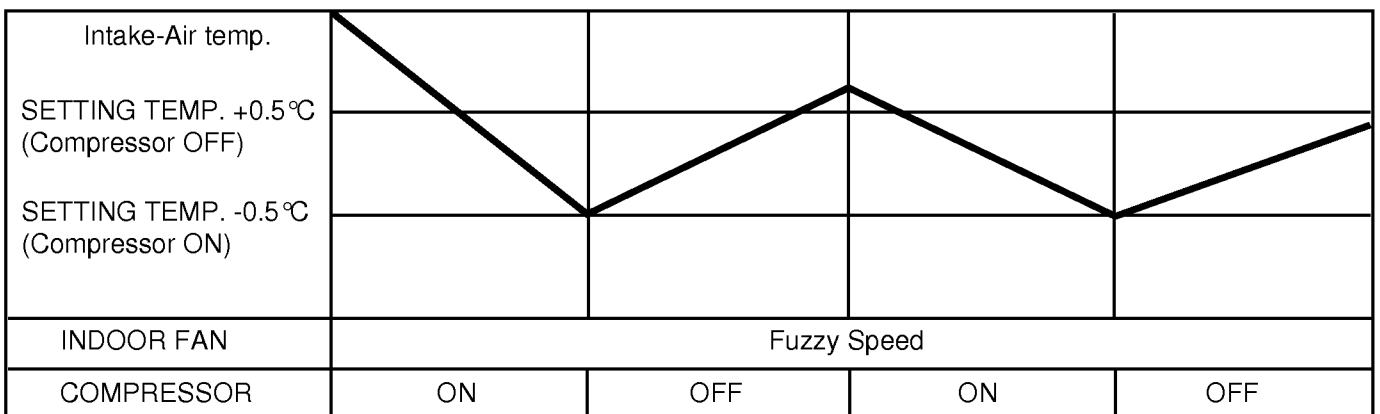

■ Auto Operation for Soft Dry

- The Setting temperature will be same that of the current intake-air temperature.
- Compressor ON temperature; Setting temperature +1 °C
- Compressor OFF temperature; Setting temperature -0.5 °C

■ Auto Operation for Heating

Intake Air temp.	below 20 °C	Over 20 °C~below 21 °C	Over 30 °C
Setting temp.	20 °C	Intake air temperature +0.5 °C	30 °C

- Compressor ON temperature; Setting temperature
- Compressor OFF temperature; Setting temperature +3 °C

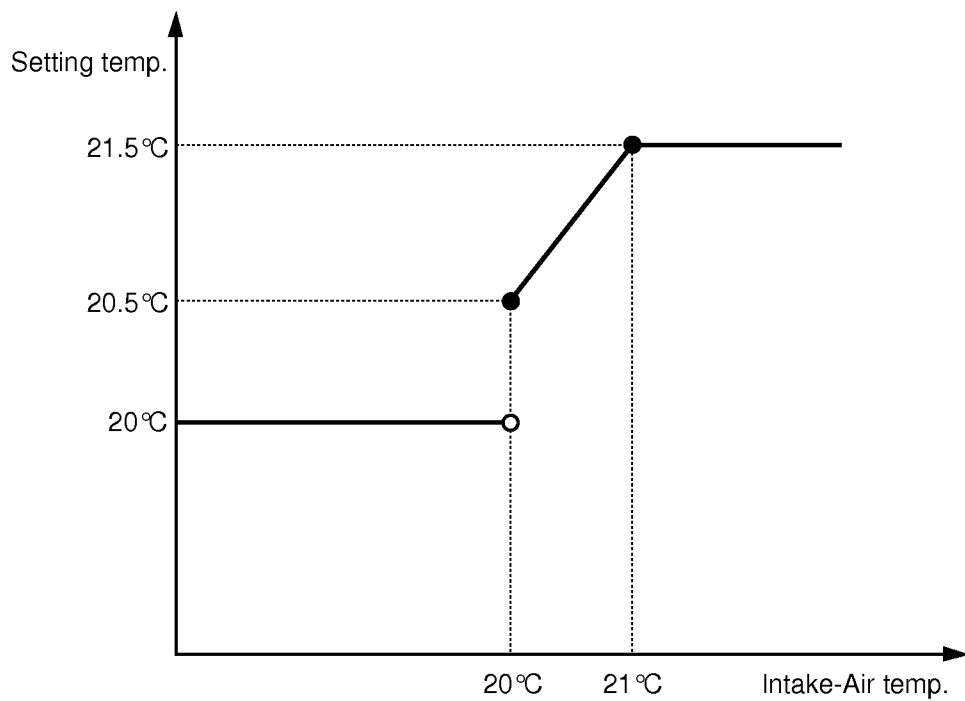

- 1/f rhythm louver operation : In Auto operation mode, when pressing the vertical air direction control button, louver moves as following cycle.

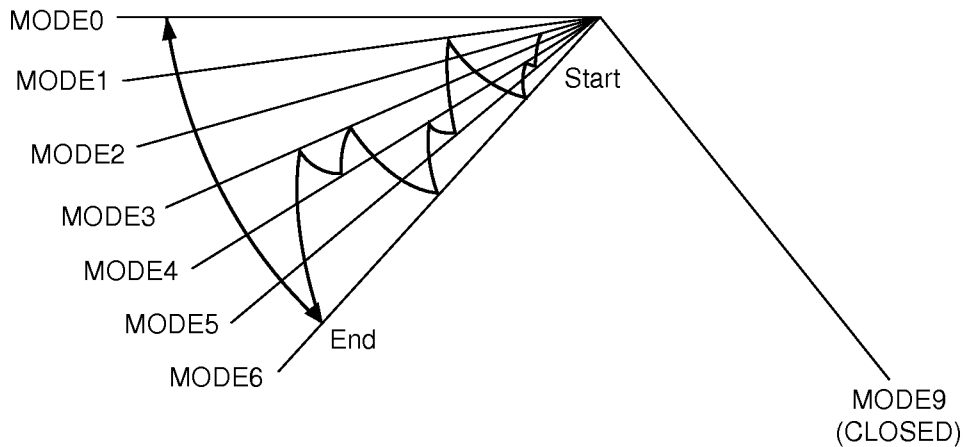

6. Heating Mode Operation

The unit will operate according to the setting by the remote controller and the operation diagram is shown as following.

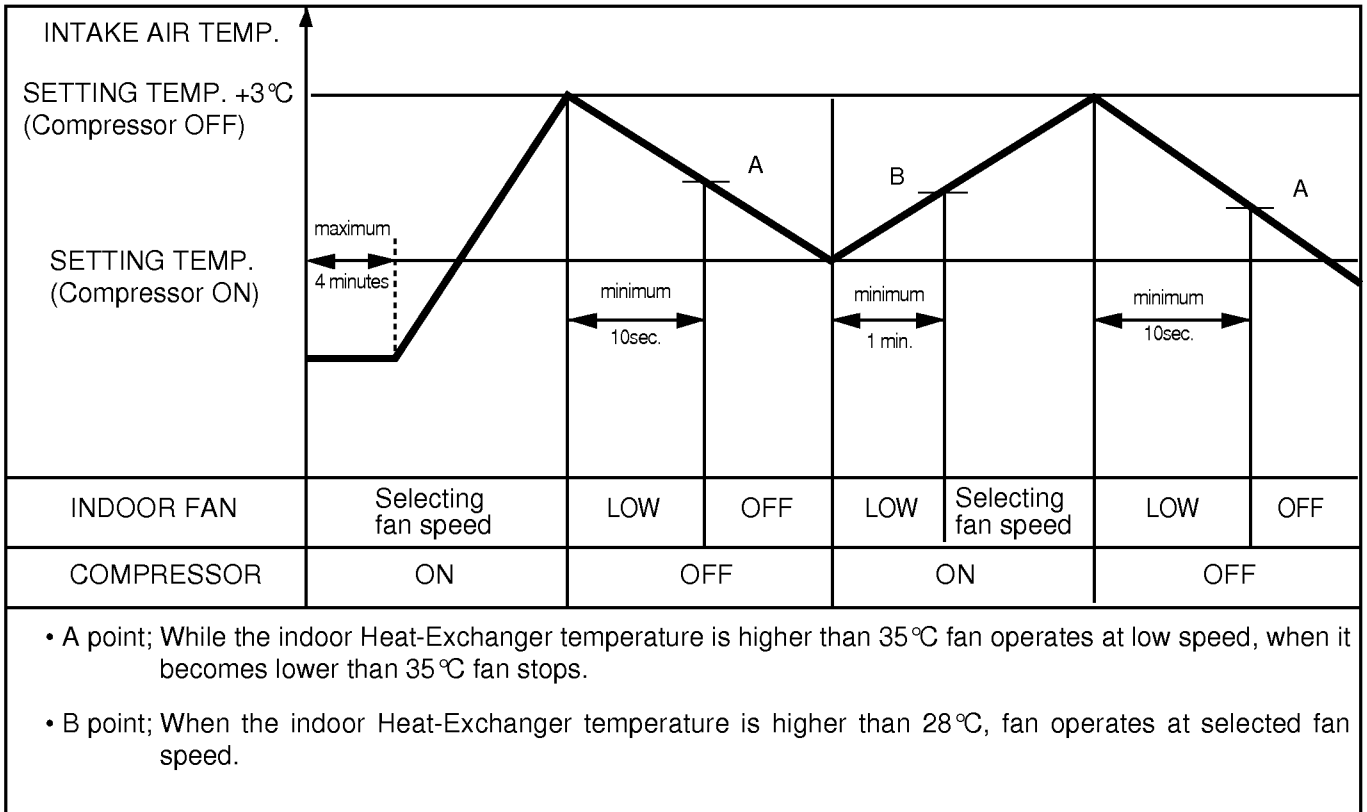

7. Hot-Start Control

- The indoor fan stops until the evaporator piping temperature will be reached to 28°C.
- During heating operation, if piping temperatures falls below 26°C fan stops.
- The operation diagram is as following.

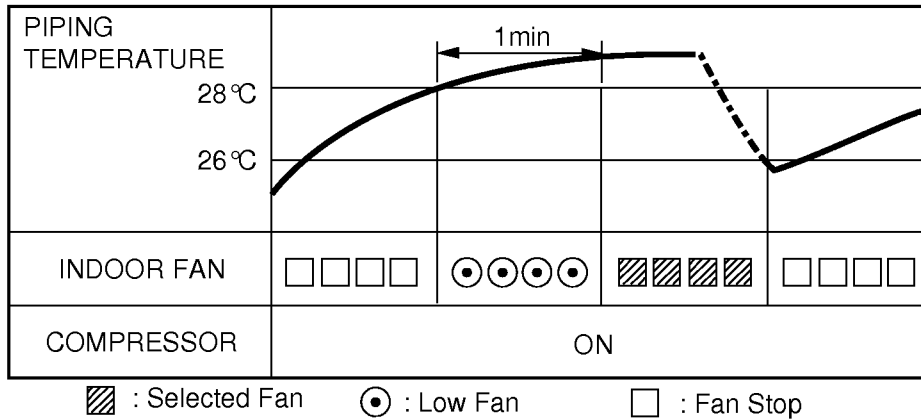

8. Deice Control

- Deicing operation is controlled by timer and sensing the outdoor piping temperature.
- The first deicing starts only when the outdoor pipe temperature falls below -6°C after 60 minutes passed from starting of heating operation and more than 10 minute operation of compressor.
- Deicing ends after 12 minutes passed from starting of deice operation or when the outdoor pipe temperature rises over 12°C even if before 12 minutes.
- The second deicing starts only when the outdoor pipe temperature falls below -6°C after 60 minutes passed from ending of the first deicing and more than 10 minutes operation of compressor.

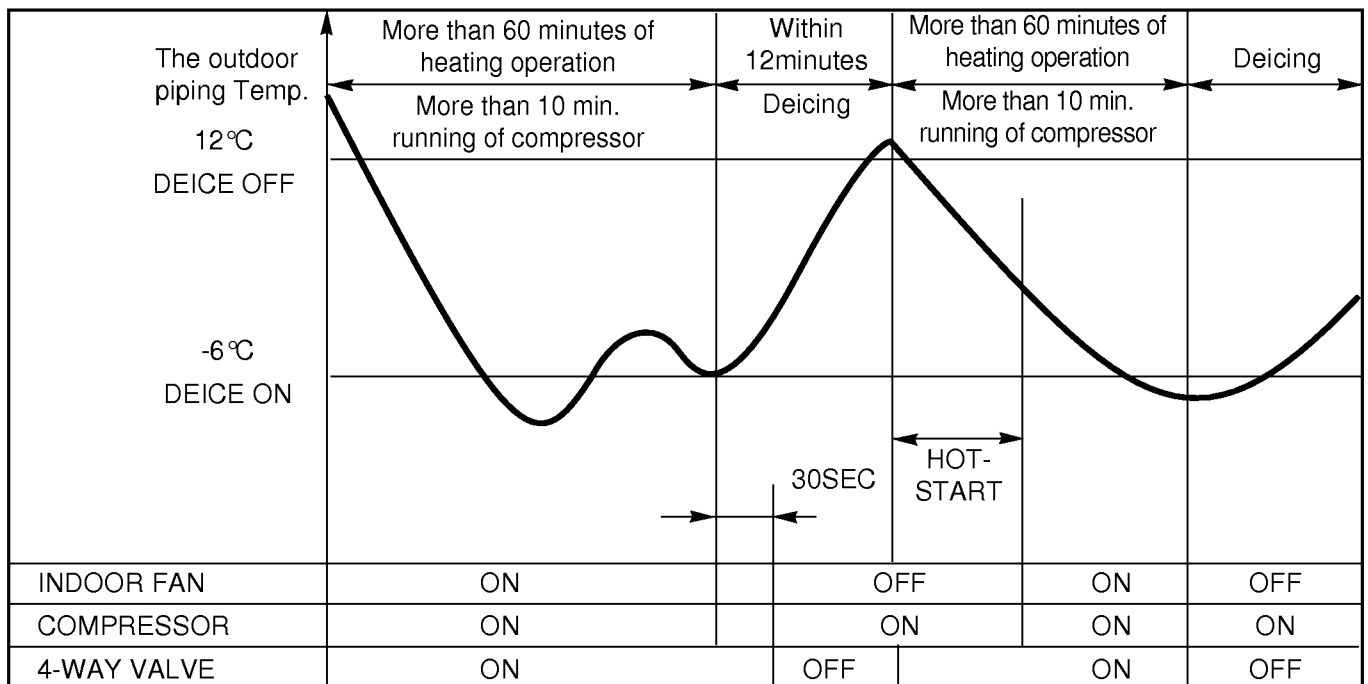

9. Soft Dry Operation.

- During Soft Dry Operation, the compressor ON temperature is the setting temperature plus 1 °C, the compressor OFF temperature is the setting temperature minus 0.5 °C.
- When the room temperature rises over the compressor ON temperature, the operation mode is switched to the cooling mode.
- When the room temperature falls between the compressor ON temperature and OFF temperature, the operation mode is switched to the Soft Dry Operation.
 In this temperature range, 10min. Dry Operation, 5.5min. operation OFF, 1.5min. only fan operation repeat.
 During 10min Dry operation, even if the room temperature falls below compressor OFF temperature, 10min(MAX) Compressor ON from starting of Dry operation which includes 4 min(MAX). Compressor ON operation below the compressor OFF temperature.
- In micom dehumidify mode, control of fan speed is as following.

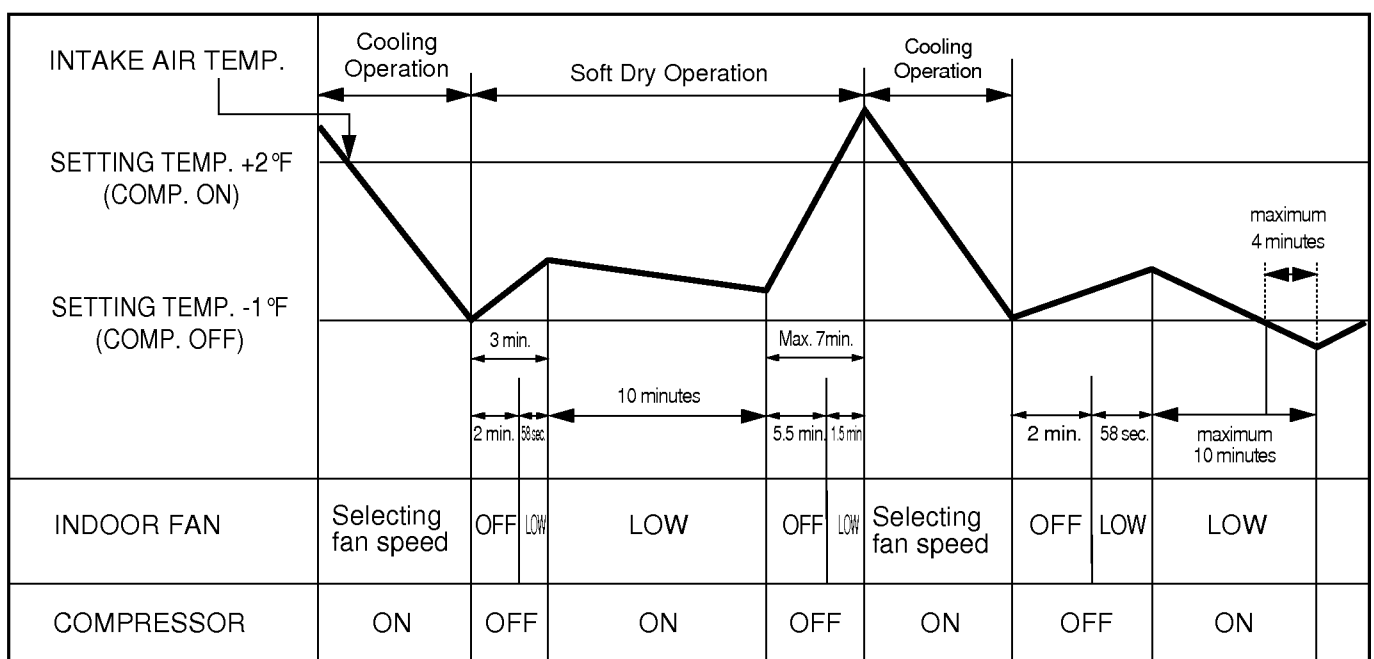

10. Protection of the evaporator pipe from frosting

- Same as item(1) except that outdoor fan motor stops when indoor coil temperature is below 3°C and restarts at the coil temperature above 6°C or after 90 seconds, if the coil temperature does not rise to 6°C, outdoor fan motor runs continuously at even below 3°C.

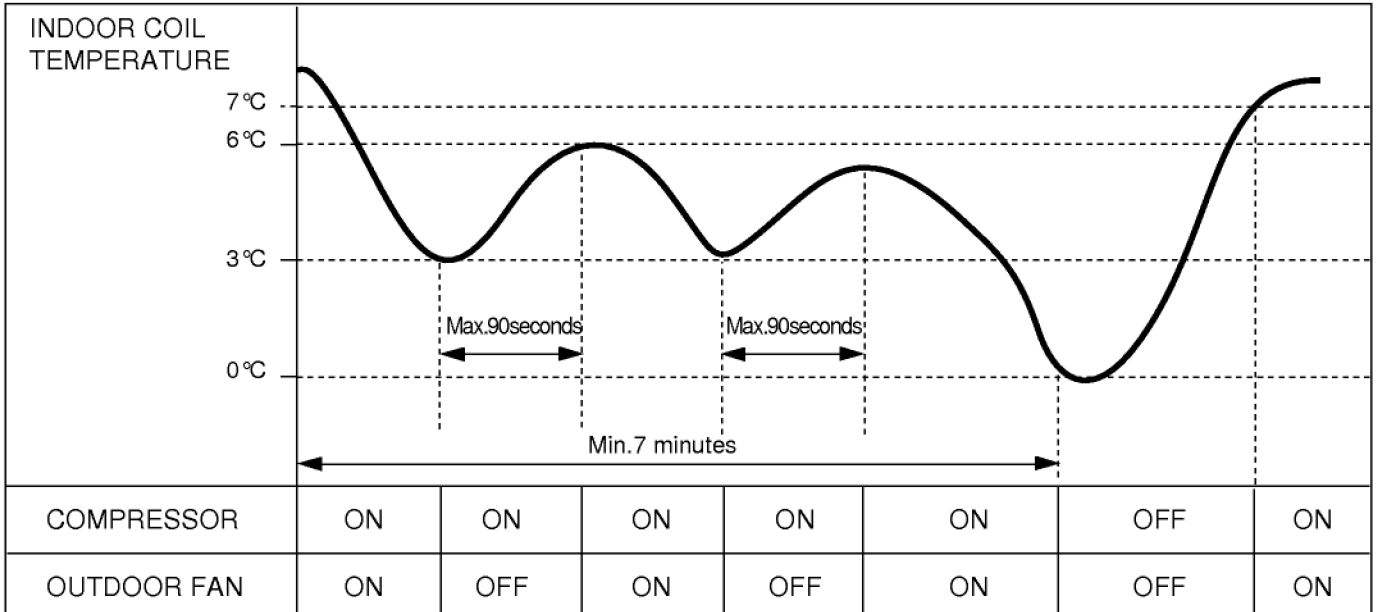

11. Forced Operation.

- If you lose wireless remote controller, you can operate the unit with forced operation switch.
- The standard conditions are as following.

	Cooling Model	Heat pump Model		
		Room Temp. $\geq 24^{\circ}\text{C}$	$21^{\circ}\text{C} \leq \text{Room Temp.} < 24^{\circ}\text{C}$	Room Temp. $< 21^{\circ}\text{C}$
Operation Mode	Cooling	Cooling	Soft Dry	Heating
FAN Speed	High	High	Soft Dry Rule	High
Setting Temp.	22°C	22°C	Air Intake Temperature	24°C

- Unit operation in low fan mode for first 15 seconds, then switched to proper operation mode according to intake Air temperature.

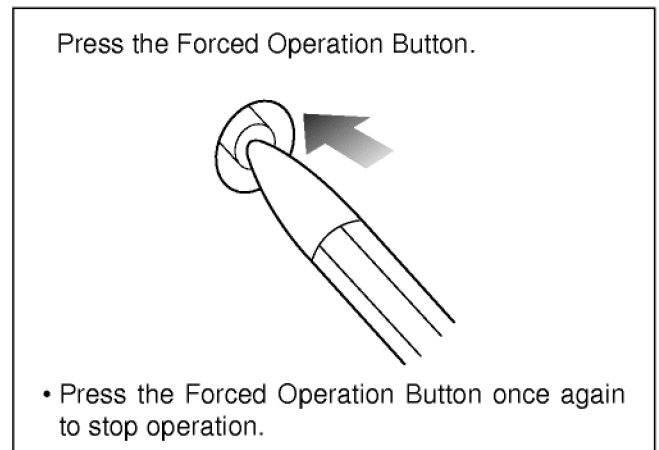
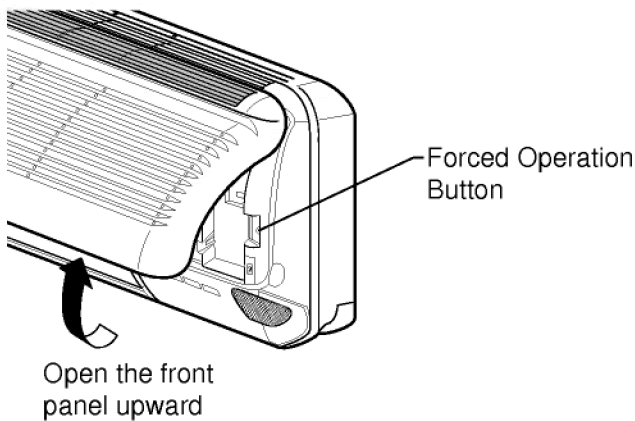

Display Function

Cooling Model

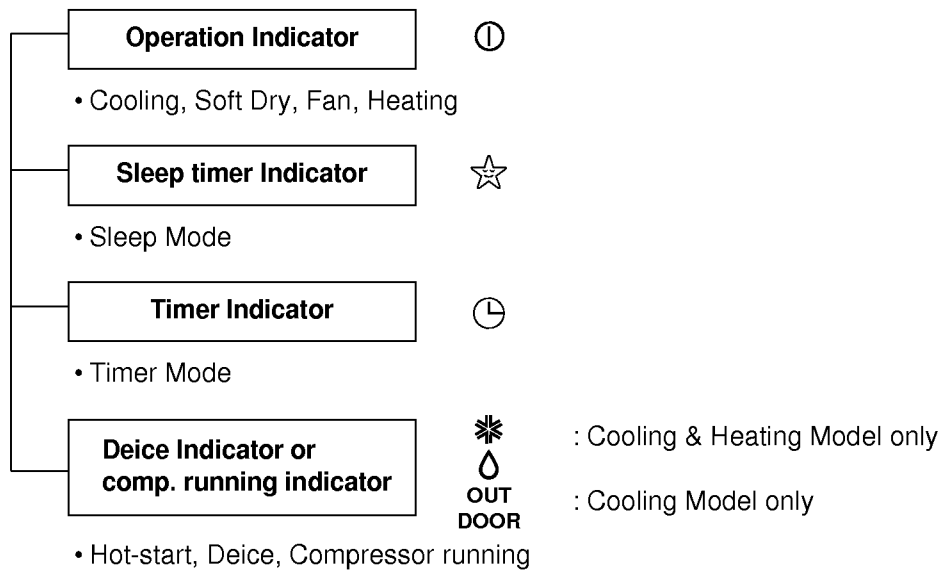

• BUZZER SOUND

- Power Input or Reset : One short beep.
- Operation Stop : One long beep.
- Remote Controller Key Input Except Operation Stop Key: Two Short beeps.
- Forced Operation Switch Input : Two short beeps.

Self-diagnosis Function

CODE NO.	DIAGNOSIS	Operation Indicator LED Blinks	Unit Operation
㉮	Indoor room temperature thermistor or pipe temperature thermistor Short/Open	Once	Still Operation
㉮	Outdoor pipe thermistor Short/Open	Twice	Outdoor Unit Off
㉮°	Communication failure between indoor and outdoor	5 times	Stop
㉮	Indoor fan locked	8 times	Stop

- LED blinks as many times as code No. (0.5 second ON/0.5 second OFF) with 3 seconds intervals.
- While the unit is off, no indication displays.
- If more than one code occurs simultaneously, bigger code No. is displayed.

Operation

(1) Name and Function-Remote Control

1) Cooling Model

Remote Controller

Signal transmitter

Transmits the signals to the room air conditioner.

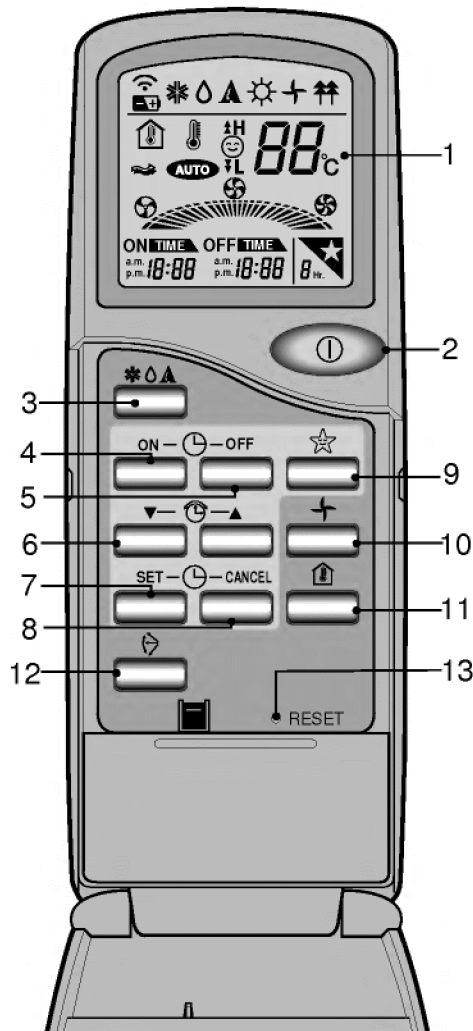

- ↙ **A Operation display**
Displays the operation conditions.
- ↙ **B Start/Stop Button**
Operation starts when this button is pressed, and stops when the button is pressed again.
- ↙ **C Operation Mode Selection Button**
Used to select the operation mode.
 - Cooling Operation Mode.
 - Soft Dry Operation Mode.
 - Auto Operation Mode.
- ↙ **D ON Timer Button**
Used to set the time of starting operation.
- ↙ **E OFF Timer Button**
Used to set the time of stopping operation.
- ↙ **F Time Setting Button**
Used to adjust the time.
- ↙ **G Timer Set Button**
Used to set the timer when the desired time is obtained.
- ↙ **H Timer CANCEL Button**
Used to cancel the timer operation.
- ↙ **I Sleep Mode Auto Button**
Used to set Sleep Mode Auto Operation.
- ↙ **J Fan Operation Button**
Used to circulate room air without cooling.
- ↙ **K Room Temperature Checking Button**
Used to check the room temperature.
- ↙ **L Airflow Direction Control Button**
Used to set the desired vertical airflow direction.
- ↙ **M Reset Button**

2) Heating Model

Remote Controller

Signal transmitter

Transmits the signals to the room air conditioner.

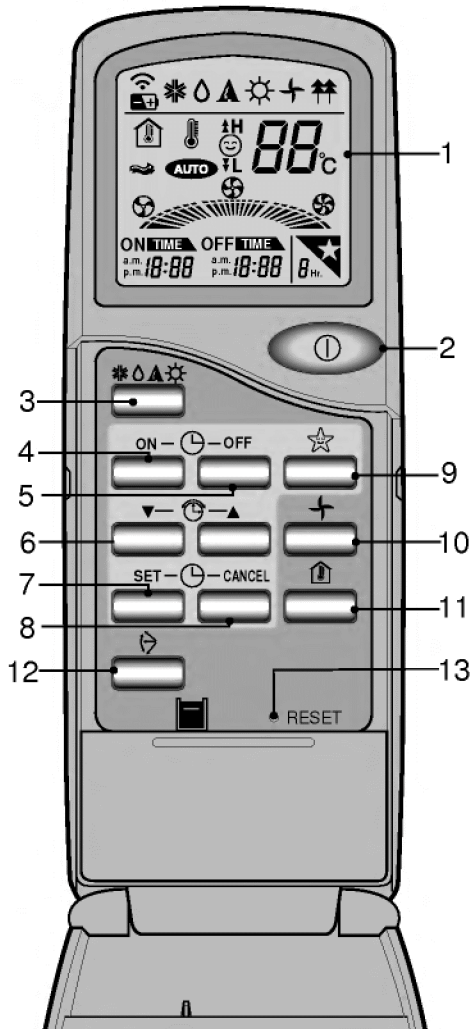

↙A **Operation display**

Displays the operation conditions.

↙B **Start/Stop Button**

Operation starts when this button is pressed, and stops when the button is pressed again.

↙C **Operation Mode Selection Button**

Used to select the operation mode.

- Cooling Operation Mode.
- Soft Dry Operation Mode.
- Auto Operation Mode.
- Heating Operation.

↙D **ON Timer Button**

Used to set the time of starting operation.

↙E **OFF Timer Button**

Used to set the time of stopping operation.

↙F **Time Setting Button**

Used to adjust the time.

↙G **Timer Set Button**

Used to set the timer when the desired time is obtained.

↙H **Timer CANCEL Button**

Used to cancel the timer operation.

↙I **Sleep Mode Auto Button**

Used to set Sleep Mode Auto Operation.

↙J **Fan Operation Button**

Used to circulate room air without heating.

↙K **Room Temperature Checking Button**

Used to check the room temperature.

↙L **Airflow Direction Control Button**

Used to set the desired vertical airflow direction.

↙M **Reset Button**