

This Owner's Manual is provided and hosted by [Appliance Factory Parts](#).



LG AG1AC17BWG Owner's Manual

[Shop genuine replacement parts for LG AG1AC17BWG](#)



[Find Your LG Air Conditioner Parts - Select From 2328 Models](#)

----- Manual continues below -----

Product Specifications (Cooling Only)

Item		Model Name		AG1AC17BWF/G/I	AG1AC23BWF/G/I	AG1AC17BKM	AG1AC23BKM
		Unit					
Cooling Capacity		BTU/h		17,000	23,000	17,300	23,000
Moisture Removal		g/h		2.5	3.1	2.5	3.1
Power Source		Ø, V, Hz		1Ø, 220-240V, 50Hz		1Ø, 220V, 60HZ	
Air Circulation	Indoor	m³/min		12.1	15	13	15
	Outdoor			42			
Noise Level	Indoor	dB(A)		45; 2	48; 2	46; 2	48; 2
	Outdoor			55; 3	57; 3	56; 3	57; 3
Input		W		1,950	2,400	2,000	2,700
Runnig Current		A		9.3	11.5	9.0	12.0
E.E.R.		BTU/h-W		8.7	9.6	8.6	8.7
Motor Output	Indoor	W		Max. 45 (BLDC MOTOR)			
	Outdoor			62			
Dimensions (W x H x D)	Indoor	mm		1,080 x 290 x 183			
	Outdoor			870 x 655 x 320			
Net. Weight	Indoor	kg		12			
	Outdoor			60	64	62	
Refrigerant(R-22)		g		900	2,000	1,430	1,950
Airflow Direction Control (Up & Down)				YES			
Deicer				NO			
Hot Start				NO			
Auto Wind				YES			
Micom Dry				YES			
Timer				24hr ON/OFF			
Self Diagnosis				YES			
Remocon type				L.C.D Wireless			
Service valve	Liquid		1/4"(6.35)				
	Gas		1/2"(12.7)	5/8"(15.88)	1/2"(12.7)	5/8"(15.88)	
Sleeping Operation				YES			
Drain Hose				YES			
Connecting Cable				0.75mm²			
Power Cord				2.5mm²			

Product Specifications (Cooling & Heating)

Item		Model Name		AG1AH17BWF/G/I	AG1AH23BWF/G/I
		Unit			
Cooling Capacity		BTU/h		17,000	23,000
Heating Capacity				18,500	23,000
Moisture Removal		g/h		2.5	3.1
Power Source		Ø, V, Hz	1Ø, 220-240V, 50Hz		
Air Circulation	Indoor	m³/min		12.1	15
	Outdoor			42	
Noise Level	Indoor	dB(A)		45±2	48±2
	Outdoor			55±3	57±3
Input	Cooling	W		1,860	2,400
	Heating			1,950	2,400
Runnig Current	Cooling	A		8.8	11.5
	Heating			9.2	11.5
E.E.R.	Cooling	BTU/h·W		8.7	9.6
C.O.P	Heating	W/W		2.8	2.8
Motor Output	Indoor	W	Max. 45(BLDC MOTOR)		
	Outdoor			62	
Dimensions (W x H x D)	Indoor	mm	1,080 x 290 x 183		
	Outdoor			870 x 655 x 320	
Net. Weight	Indoor	kg	12		
	Outdoor			62	65
Refrigerant(R-22)		g		1,270	1,630
Airflow Direction Control (Up & Down)			YES		
Deicer			YES		
Hot Start			YES		
Auto Wind			YES		
Micom Dry			YES		
Timer			2hr ON/OFF		
Self Diagnosis			YES		
Remocon type			L.C.D Wireless		
Service valve	Liquid		1/4"(6.35)		
	Gas		1/2"(12.7)	5/8"(15.88)	
Sleeping Operation			YES		
Drain Hose			YES		
Connecting Cable			0.75mm²		
Power Cord			2.5mm²		

Dimensions

(1) Indoor Unit

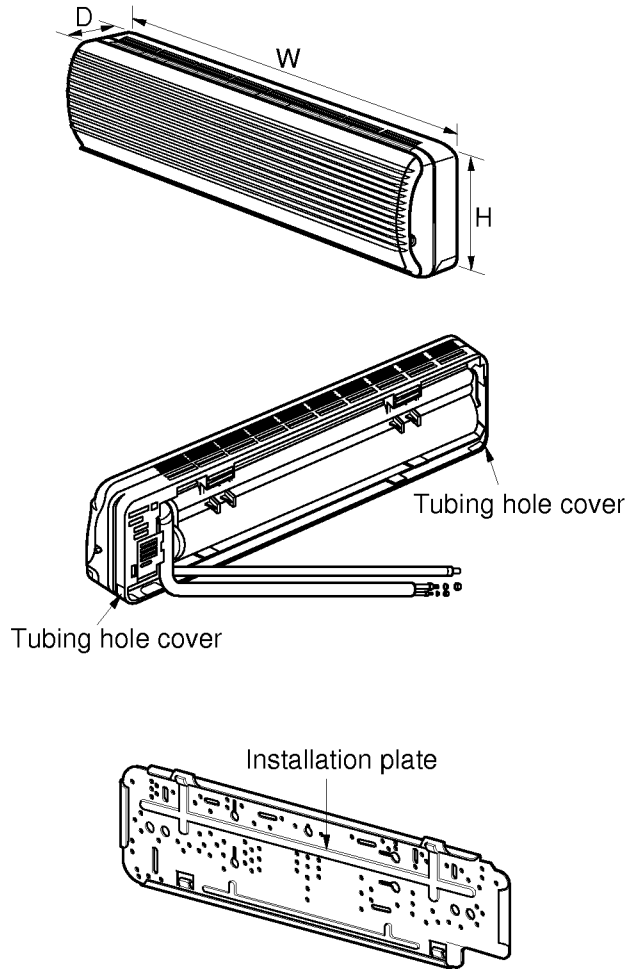

MODEL		ALL MODELS
DIM		
W	mm	1,080
H	mm	290
D	mm	183

(2) Outdoor Unit

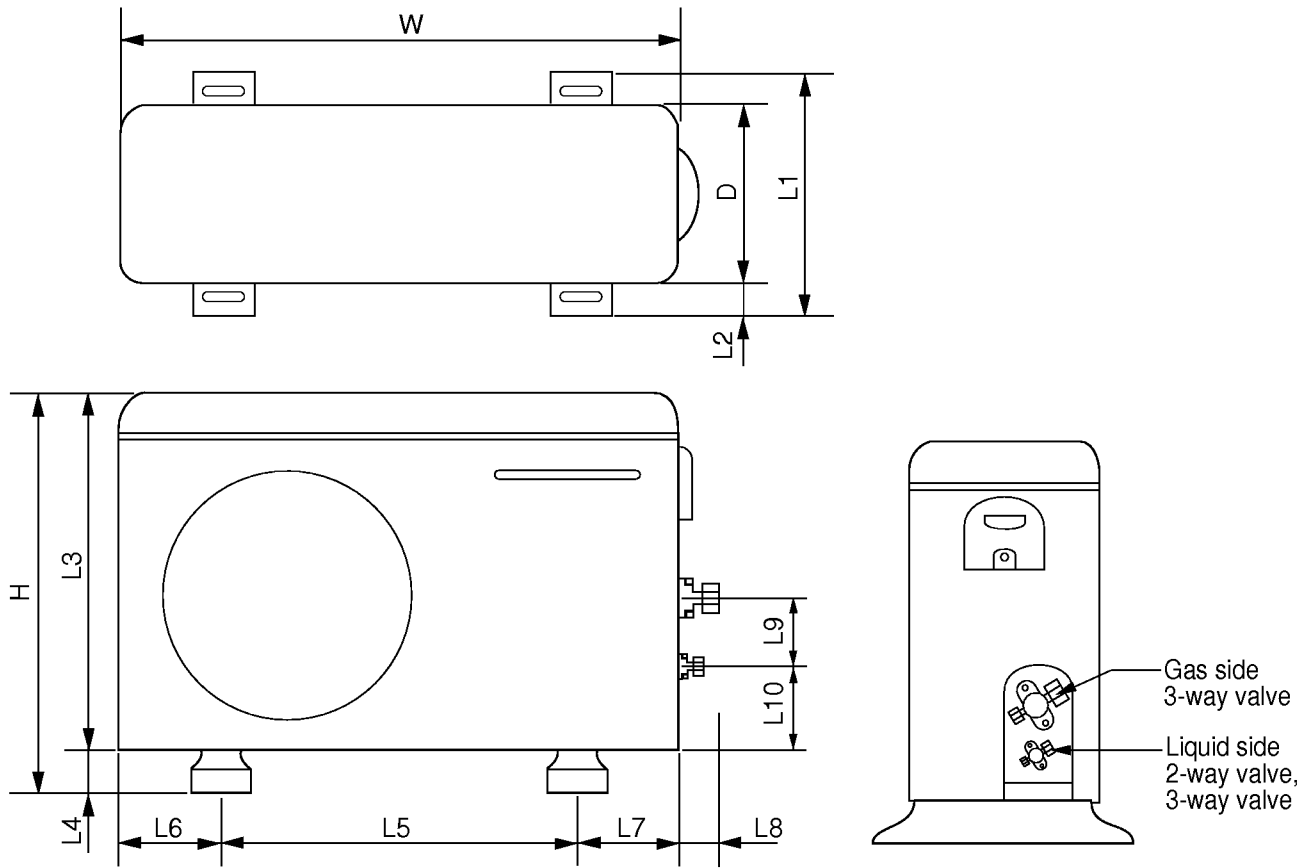

MODEL		ALL MODELS	
DIM			
W	mm	870	
H	mm	655	
D	mm	320	
L1	mm	370	
L2	mm	25	
L3	mm	630	
L4	mm	25	
L5	mm	546	
L6	mm	162	
L7	mm	162	
L8	mm	54	
L9	mm	74.5	
L10	mm	79	