

This Owner's Manual is provided and hosted by [Appliance Factory Parts](#).



LG AG1AC17BWI Owner's Manual

[Shop genuine replacement parts for LG AG1AC17BWI](#)



[Find Your LG Air Conditioner Parts - Select From 2328 Models](#)

----- Manual continues below -----

Installation

1. Installation of Indoor, Outdoor unit

1) Selection of the best location

1. Indoor unit.

- There should not be any heat source or steam near the unit.
- There should not be any obstacles to prevent the air circulation.
- A place where air circulation in the room will be good.
- A place where drainage can be easily obtained.
- A place where noise prevention is taken into consideration.
- Do not install the unit near the door way.
- Ensure the spaces indicated by arrows from the wall, ceiling, fence, or other obstacles.

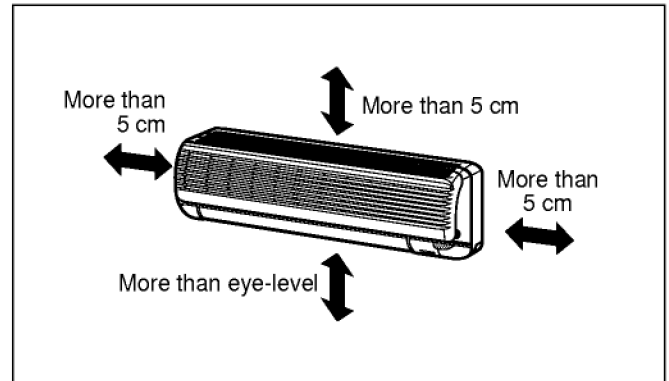

2. Outdoor unit.

- If an awning is built over the unit to prevent direct sunlight or rain exposure, be careful that heat radiation from the condenser is not restricted.
- There should not be any animals or plants which could be affected by hot air discharged.
- Ensure the spaces indicated by arrows from the wall, ceiling, fence, or other obstacles.

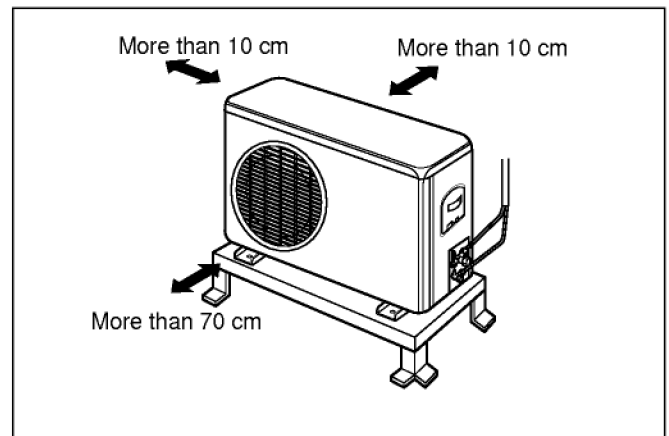

3.Piping length and the elevation

MODEL	Pipe Size		Max. length A (m)	Max. Elevation B (m)
	GAS	LIQUID		
23K	5/8"	1/4"	15	8
17K	1/2"	1/4"	15	8

Refer to refrigeration cycle diagram for details.
(page 9,10)

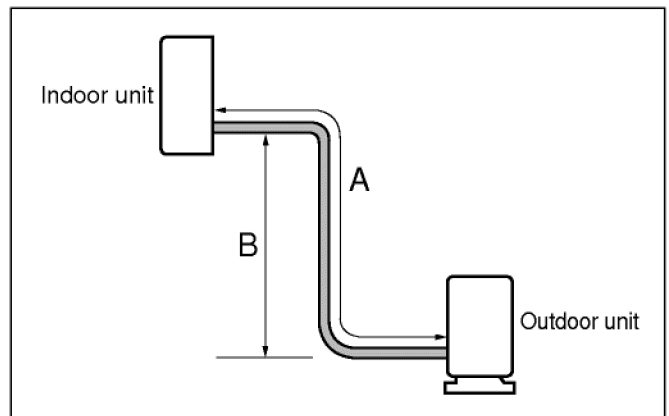

2) Indoor Unit Installation

The mounting wall should be strong and solid enough to prevent it from the vibration.

1. Mount the installation plate on the wall with four Type "A" screws.

(if mounting the unit on the concrete wall, consider using anchor bolts.)

- Always mount the Installation plate horizontally by aligning the marking-off line by means of the thread and a level.

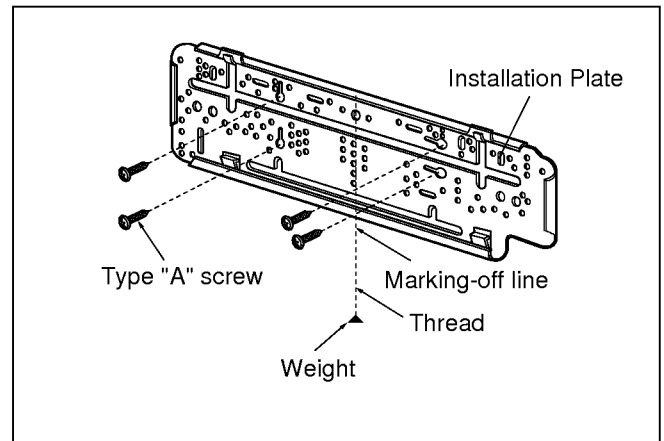

2. Drill the piping hole with 70mm dia. holecore drill.

- For right rear piping, draw a line in the direction of the arrow marked "A" and make another line extended from the bottom line of installation plate. The meeting point of two lines is the center of the hole.
- For left rear piping, draw a line extended left from the bottom line of the installation plate. This is the center line of any hole for the left rear installation.
- Drill the Piping hole at either the right or the left and the hole should be slightly slanted to the outdoor side.

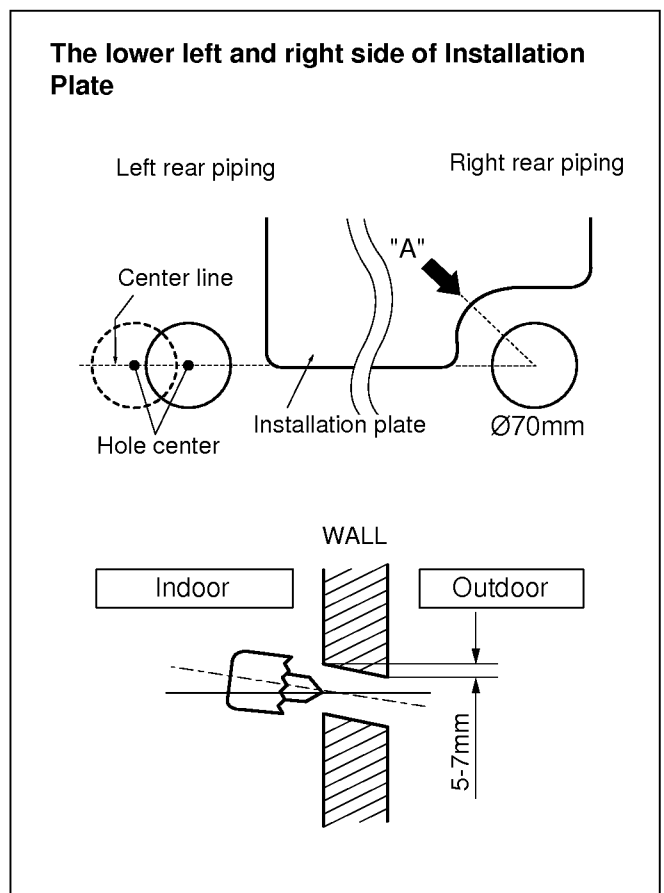

2. Piping and Drainage of Indoor Unit

1) Preparation of Pippings

1. Cut the pipes and the cable.

- Use the accessory piping kit or the pipes purchased locally.
- Measure the distance between the indoor and the outdoor unit.
- Cut the pipes a little longer than measured distance.
- Cut the cable 1.5m longer than the length of the pipe.

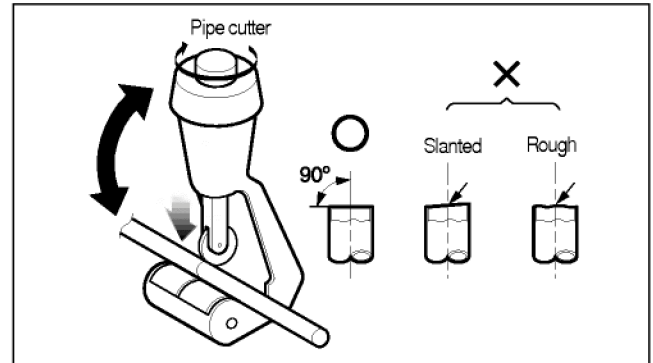

2. Remove burrs.

- Remove burrs from cut edges of pipes.
- Turn the pipe end toward down to avoid the metal powder entering the pipe.

Caution:

If burrs are not removed, they may cause a gas leakage.

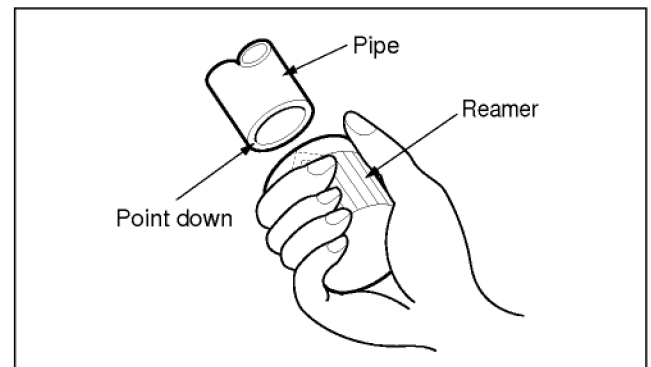

3. Flaring the pipes.

- Insert the flare nuts, mounted on the connection ports of both indoor and outdoor unit, onto the copper pipes. Some gas may leak, when the flare nuts are removed from the indoor unit, as some gas is charged to prevent the inside of the pipe from rusting.
- Fit the copper pipe end into the Bar of flare tool about 0.5~1.0mm higher. (See illustration)
- Flare the pipe ends.

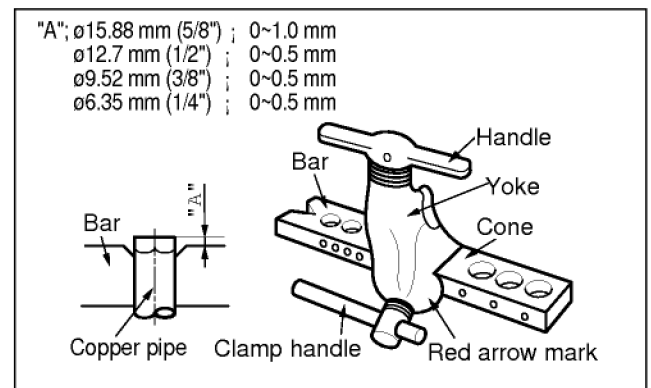

4. Tape the flaring portion to protect it from the dust or damages.

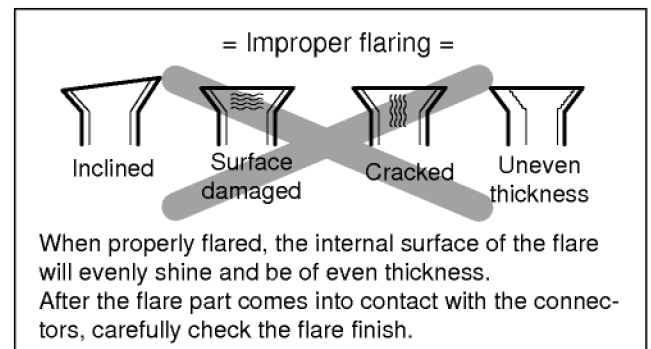

2) Connection of Pipings

1. Remove the indoor tubing with Drain hose from the hole

- Remove tubing holder and pull the tubing out of the chassis.

2. Replace the tubing holder into original position.

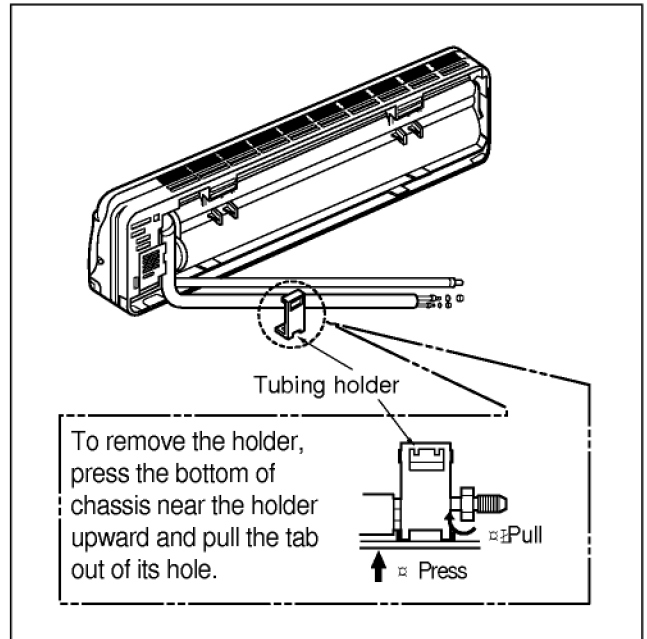

For right rear piping

3. Route the tubing and the drain hose straight backwards.

4. Insert the connecting cable into the indoor unit through the piping hole.

- Do not connect the cable to the indoor unit.
- Make a small loop with the cable for easy connection later.

5. Tape the tubing, drain hose and the connecting cable. Be sure that drain hose locates at the lowest side of the bundle. Locating at the upper side can be a reason that drain water overflows drain pan inside the unit.

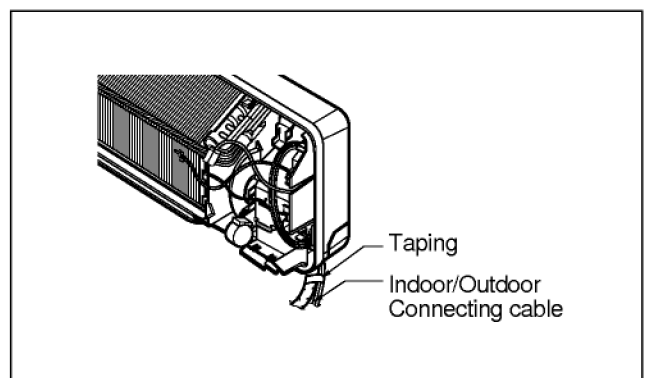
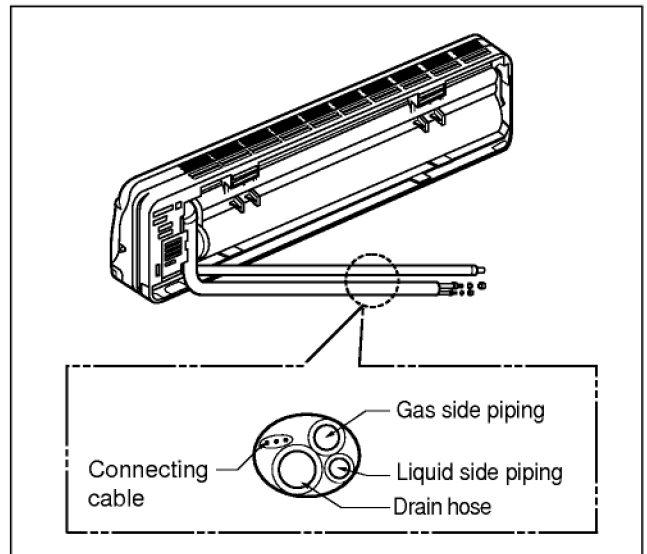

6. Indoor unit installation

- Hook the indoor unit onto the upper portion of installation plate. (Engage the two hooks of the rear top of the indoor unit with the upper edge of the installation plate.)
Ensure the hooks are properly seated on the installation plate by moving it left and right.

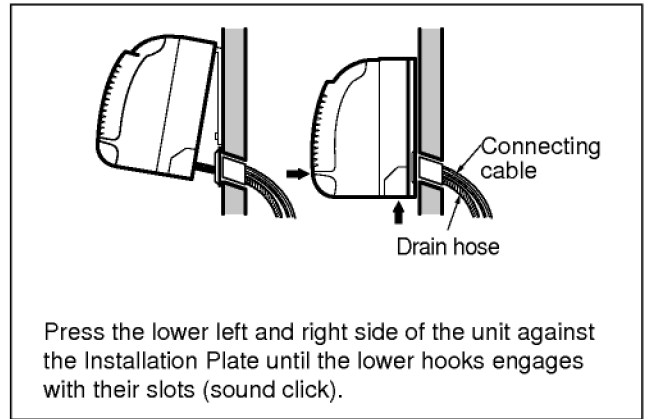

7. Connecting the pipings to the indoor unit.

- Align the center of the pipings and sufficiently tighten the flare nut with fingers.
- Finally, tighten the flare nut with torque wrench until the wrench clicks.
When tightening the flare nut with torque wrench, ensure the direction for tightening follows the arrow on the wrench.

Pipe Size	Torque
Liquid Side (1/4")	1.8kg·m
Liquid Side (3/8")	4.2kg·m
Gas Side (1/2")	5.5kg·m
Gas Side (5/8")	6.6kg·m

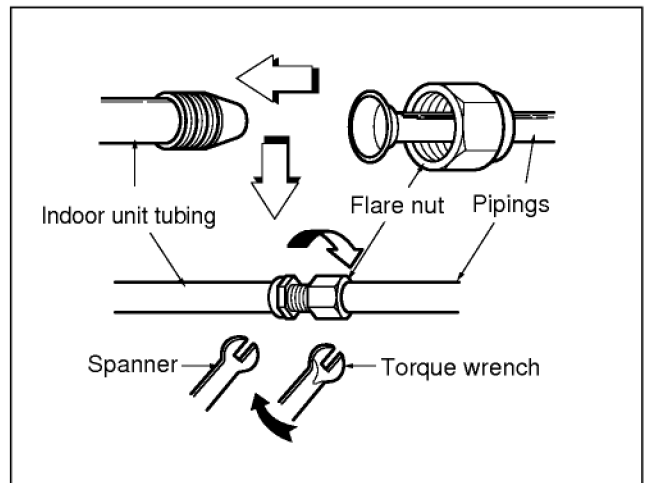

8. Wrap the insulation material around the connecting portion.

CAUTION: Take care to arrange the pipings, drain hose and cables as the picture on page 27 for inserting it into the indoor unit and refixing the tubing holder easily.

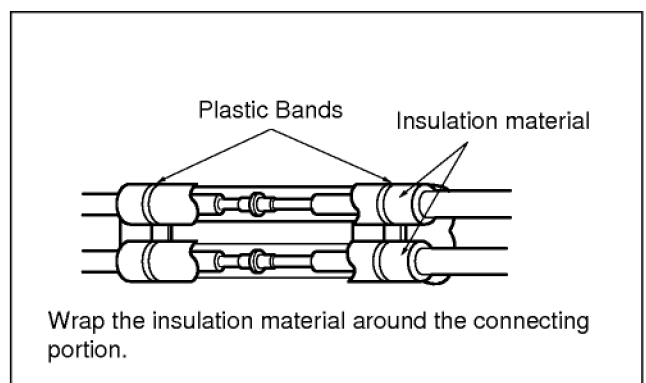

For the left pipings

3. Route the indoor tubing with the drain hose to the piping hole as desired position.

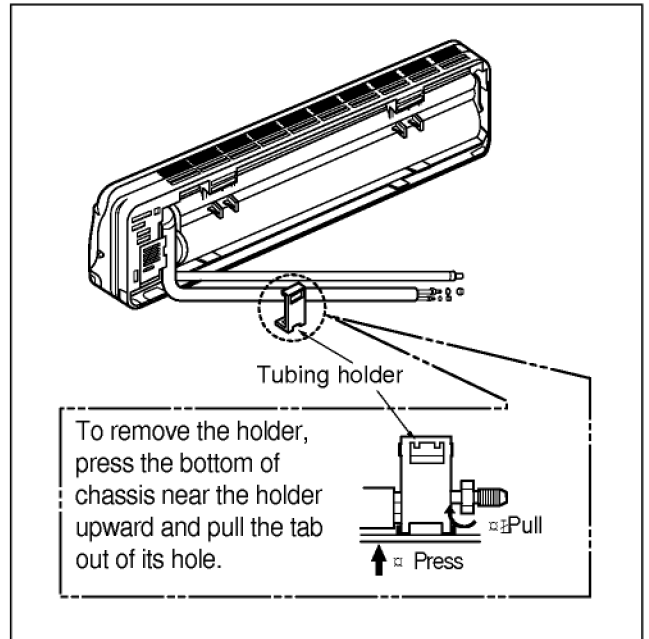

4. Insert the pipings, power supply cord and connecting cable into the piping hole.

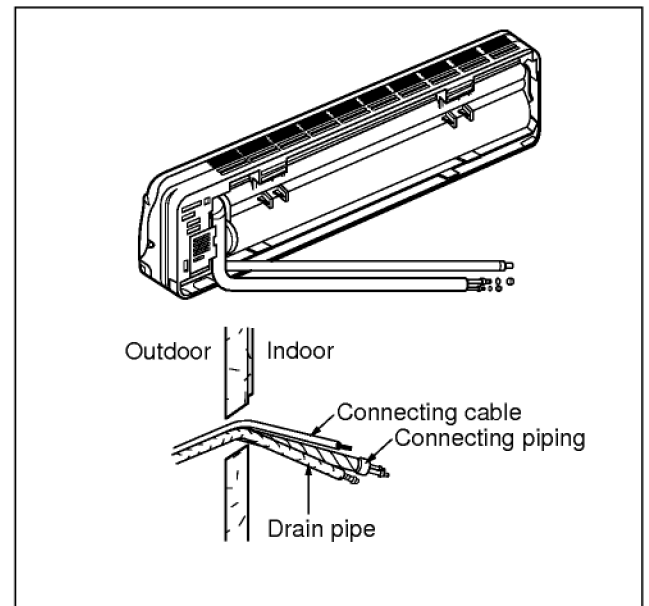

5. Insert the connecting cable into the indoor unit.

- Don't connect the cable to the indoor unit.
- Make a small loop with the cable for easy connection later.

6. Tape the tubing, drain hose and the connecting cable.

7. Indoor unit installation

- Hook the indoor unit onto the upper portion of installation plate. (Engage the two hooks of the rear top of the indoor unit with the upper edge of the installation plate.)
Ensure the hooks are properly seated on the installation plate by moving it in left and right.

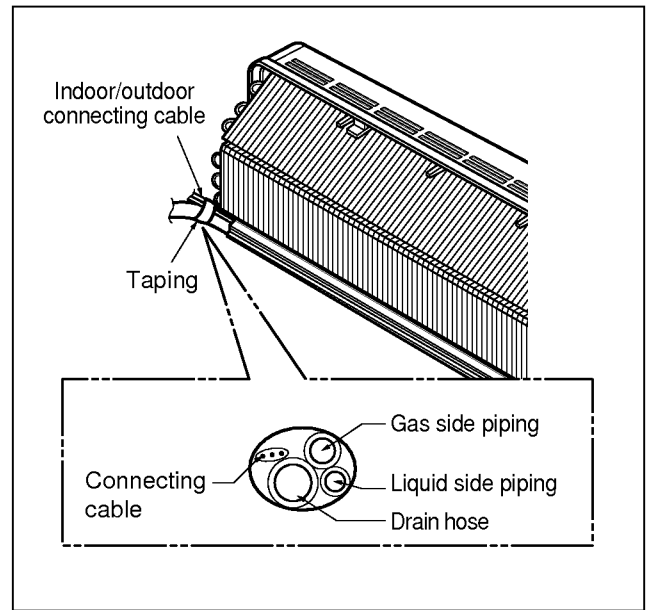

8. Connecting the pipings to the indoor unit.

- Align the center of the pipings and sufficiently tighten the flare nut with fingers.
- Finally, tighten the flare nut with torque wrench until the wrench clicks.
When tightening the flare nut with torque wrench, ensure the direction for tightening follows the arrow on the wrench.

Pipe Size	Torque
Liquid Side (1/4")	1.8kg·m
Liquid Side (3/8")	4.2kg·m
Gas Side (1/2")	5.5kg·m
Gas Side (5/8")	6.6kg·m

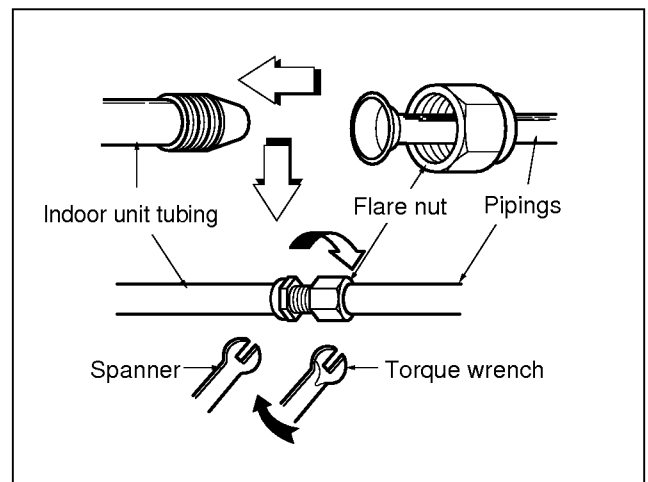

9. Wrap the insulation material around the connecting portion.

CAUTION: Take care to arrange the pipings, drain hose and cables as the right upper picture for inserting it into the indoor unit and refixing the tubing holder easily.

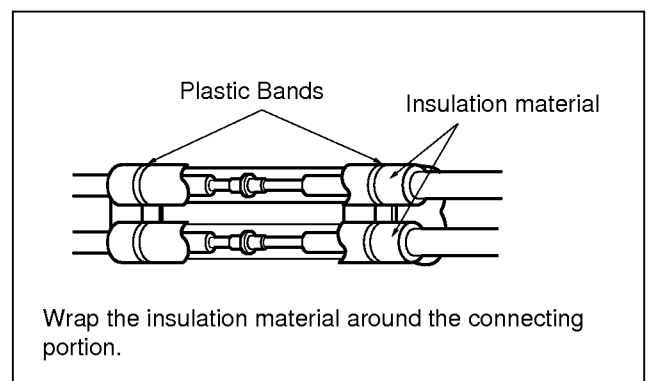

10. Set the pipings and the connecting cable to the back of the chassis with the tubing holder

- Hook the edge of tubing holder to tap on chassis and push the bottom of tubing holder to be engaged in the bottom of chassis.

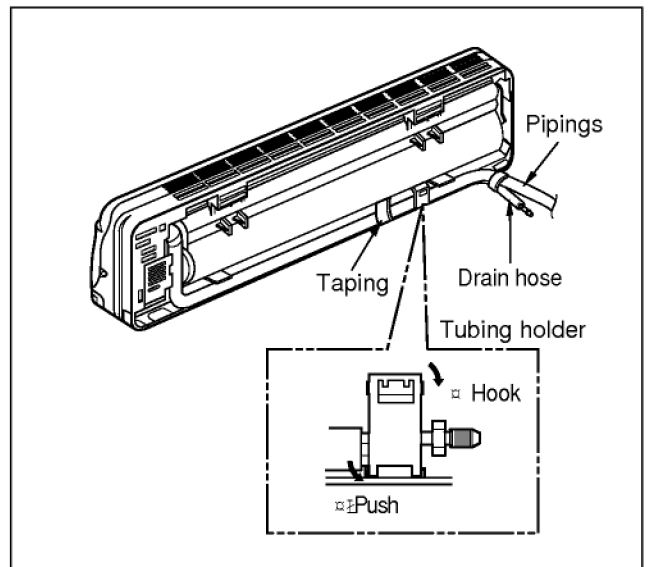
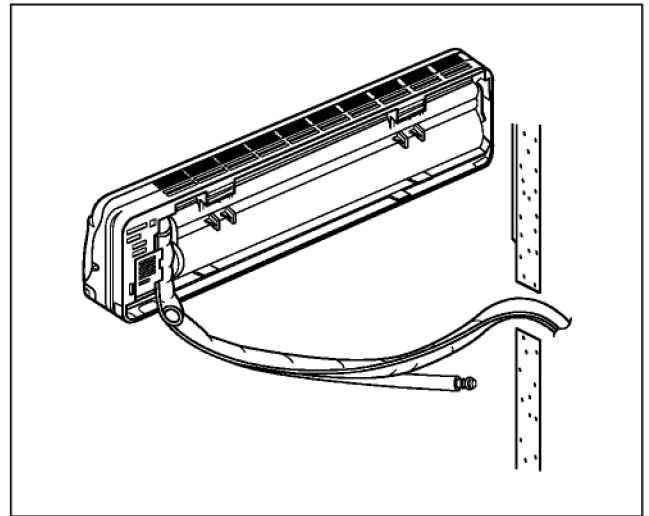

11. Indoor unit installation

- Hook the indoor unit onto the upper portion of installation plate. (Engage the two hooks of the rear top of the indoor unit with the upper edge of the installation plate.)
Ensure the hooks are properly seated on the installation plate by moving it left and right.

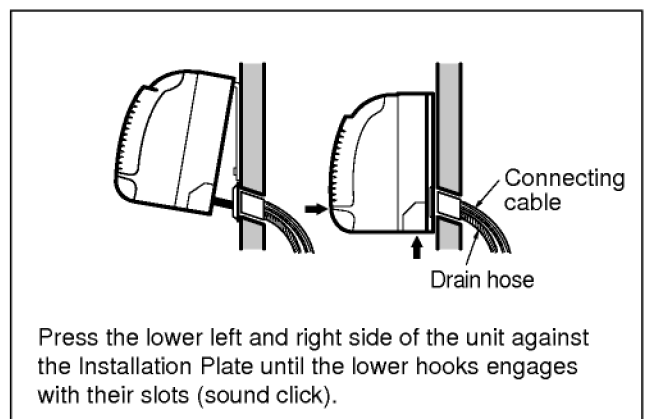

3. Connecting Pipings and the cable to Outdoor unit

1) Connecting the pipings to the Outdoor unit

1. Align the center of the pipings and sufficiently tighten the flare nut with fingers.
2. Finally, tighten the flare nut with torque wrench until the wrench clicks.
 - When tightening the flare nut with torque wrench, ensure the direction for tightening follows the arrow on the wrench.

Pipe Size	Torque
Liquid Side (1/4")	1.8kg.m
Liquid Side (3/8")	4.2kg.m
Gas Side (1/2")	5.5kg.m
Gas Side (5/8")	6.6kg.m

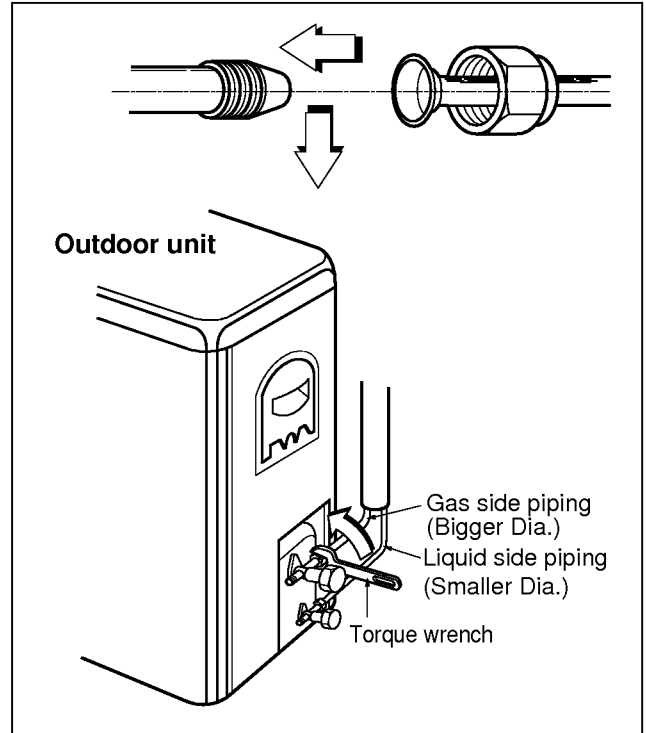

2) Connection of the cable

1. Remove the cover control from the unit by loosening the screw.
Connect the wires to the terminals on the control board individually as the following.

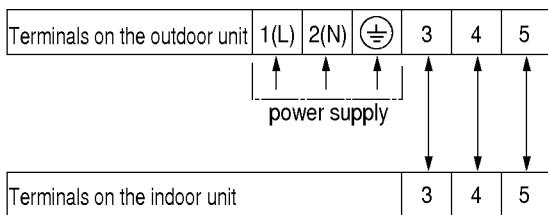

2. Secure the cable onto the control board with the holder (clammer).
3. Refix the cover control to the original position with the screw.

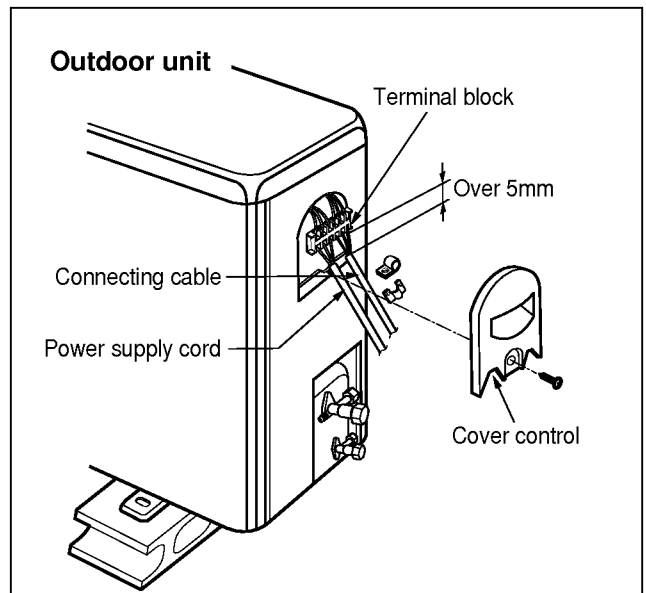

CAUTION: Wrong connection causes fatal damage to P.C.B.

4. Checking the Drainage and Connecting the cable to Indoor unit

1) Checking the Drainage

1. Remove the Grille from the cabinet.

- Set the up-and-down air direction louver to open position (horizontally) by finger pressure.
- Remove 3 screws.
- To remove the Grille, pull lower the left and right side of the grille toward you (slightly tilted) and lift it straight upward (Four tabs on the top inside edge of chassis are clear of their slots).

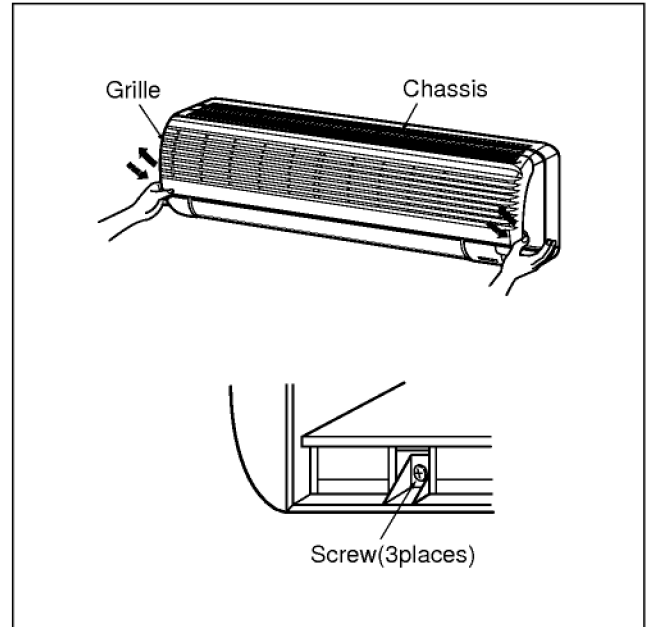

2. Check the drainage.

- Pour a glass of water on the evaporator.
- Ensure if water flows drain hose of indoor unit without any leakage.

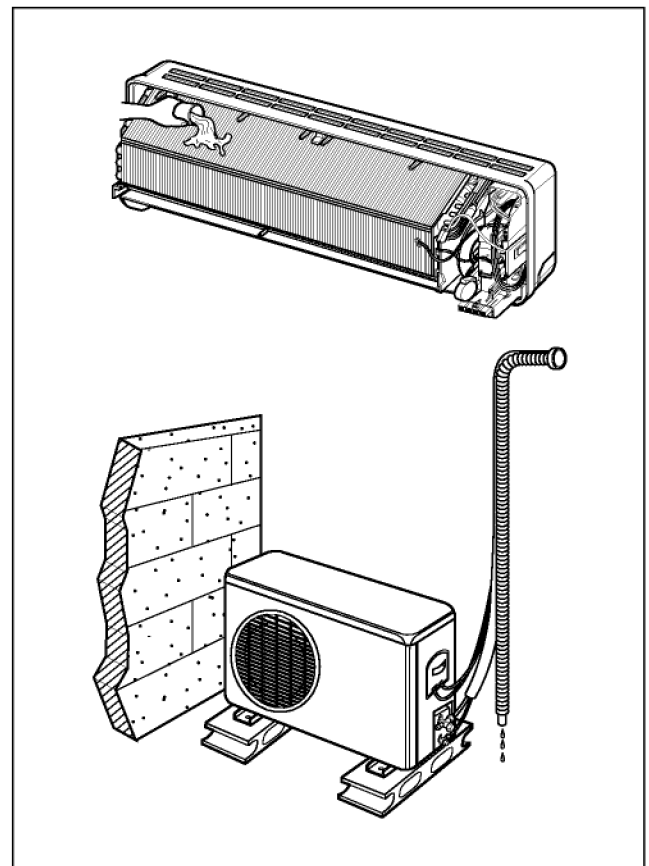

2) Connect the cable to the indoor unit

1. Connect the wires to the terminals on the control board individually according to the outdoor unit connection.

- Ensure that the color of the wires of outdoor unit and the terminal No. are the same as those of indoor unit respectively.

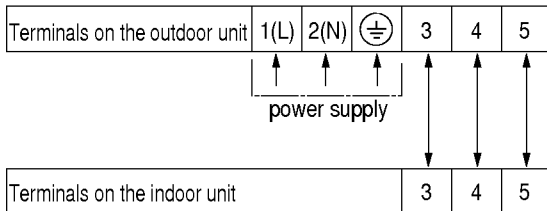

CAUTION: Wrong connection causes fatal damage to P.C.B.

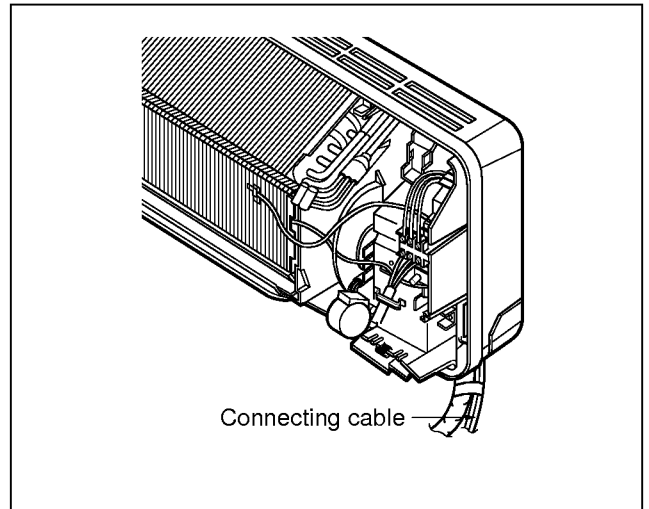

CAUTION:

- The power supply cord connected to the outdoor unit should be complied with 2.5mm² conductors. (Type H07RN-F, TUV or VDE Approval)
- The connecting cable connected to the indoor and outdoor unit should be complied with 0.75mm² conductors. (Type H05RN-F, TUV or VDE Approval)
- This appliance must be installed in accordance with current National Wiring Regulations.
- Connecting cable between indoor unit and outdoor unit shall be approved and the size of conductor shall be in accordance with local law.

2. Attach the Grille onto the cabinet.

- Grasp the lower left and right side of the Grille and engage four tabs on the top inside edge of the chassis.
- Press the Grille toward the chassis until it will be back into place.

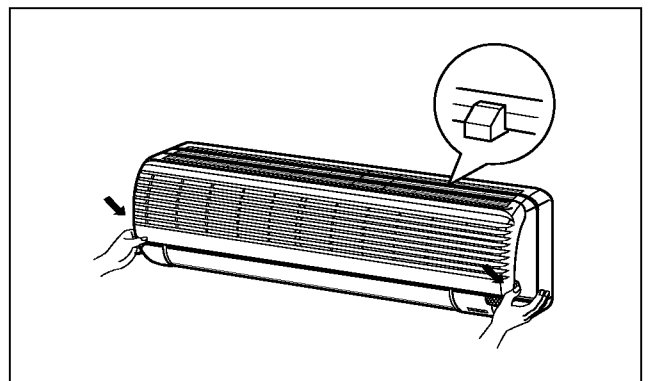

3) Form the pipings

1. Wrap the connecting portion of indoor unit with the Insulation material and secure it with two Plastic Bands.(for the right pipings)

- If you want to connect an additional drain hose, the end of the drain-outlet should keep distance from the ground.(Do not dip it into water, and fix it on the wall to avoid swinging in the wind.)

In case of the Outdoor unit being installed below position of the Indoor unit.

- 2. Tape the Pipings, drain hose and Connecting Cable from down to up.**
- 3. Form the pipings gathered by taping along the exterior wall and fix it onto the wall by saddle or equivalent.**

In case of the Outdoor unit being installed above position of the Indoor unit.

- 2. Tape the Pipings and Connecting cable from down to up.**
- 3. Form the pipings gathered by taping along the exterior wall, and make the trap prevent water from entering into the room.**
- 4. Fix the pipings onto the wall by saddle or equivalent.**

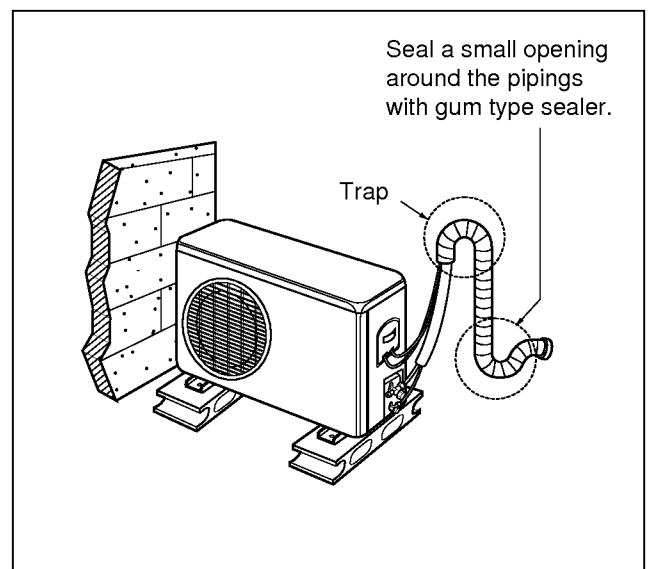
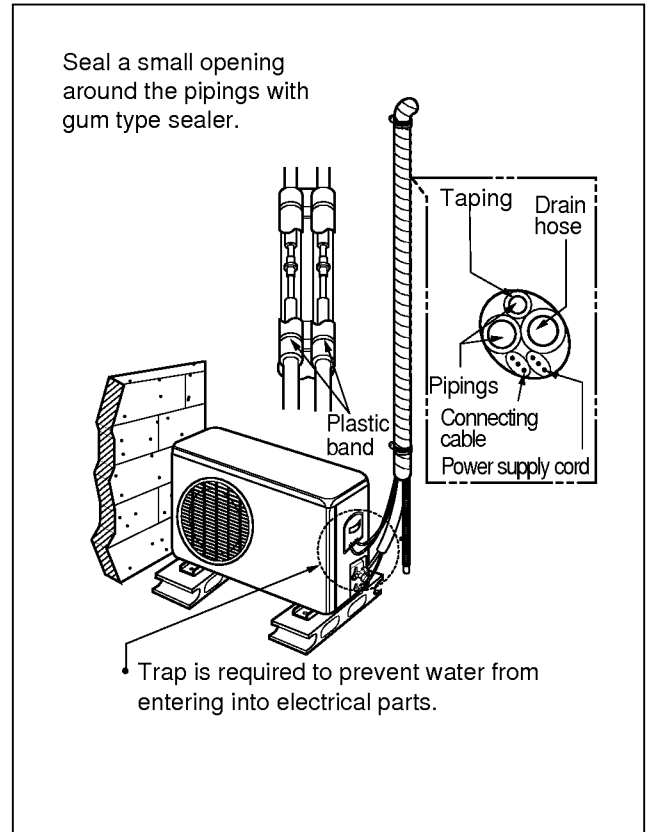

5. Air Purging

1) Air purging

The air which contains moisture remaining in the refrigeration cycle may cause a malfunction on the compressor.

1. Remove the caps from the gas side and liquid side valves.
2. Remove the service-port cap from the gas side valve.
3. Turn the valve stem of liquid side valve counter-clockwise approx. 90° and hold it there for ten seconds, then close it.
4. Check a gas-leakage of the connecting portion of the pipings.

CAUTION: Do not leak the gas in the air during air purging. Use vacuum pump as far as possible.

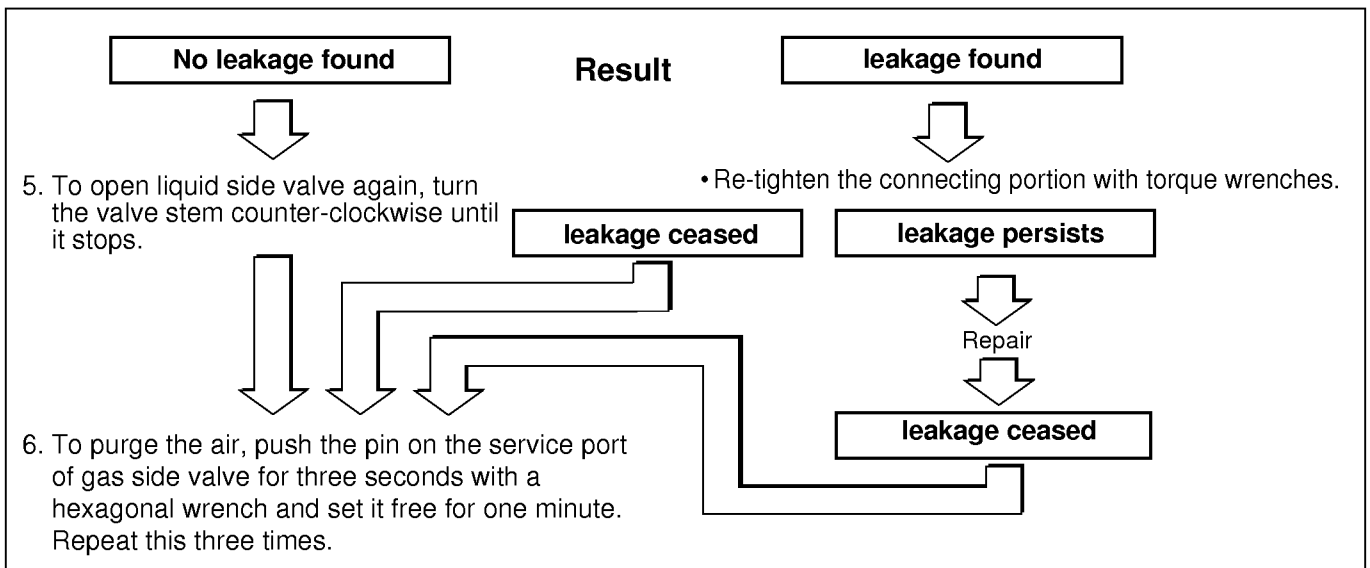
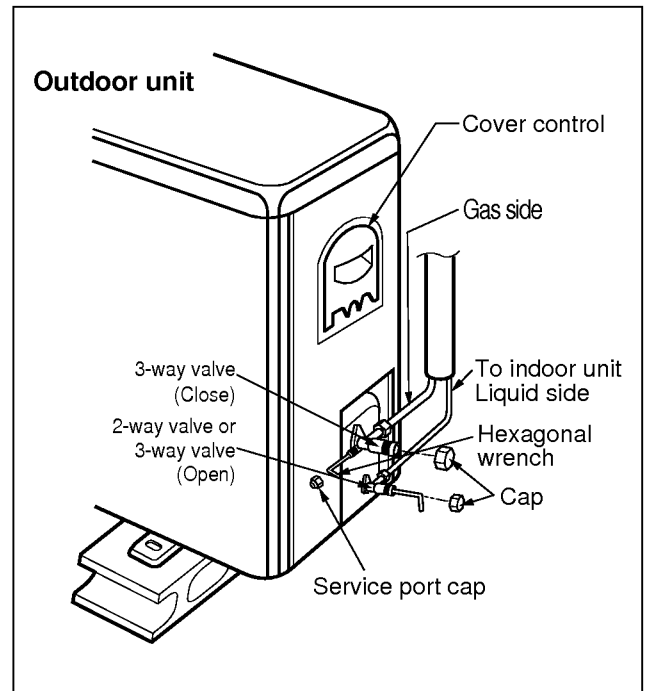

7. Set the both liquid and gas side valves to open position with the Hexagonal wrench for the unit operation.

8. Checking a gas leakage

- (1) Connect the manifold gauge to the service port of gas side valve.
Measure the pressure.
- (2) Keep it for 5-10 minutes.
Ensure if the pressure indicated on the gauge is as same as that of measured at first time.

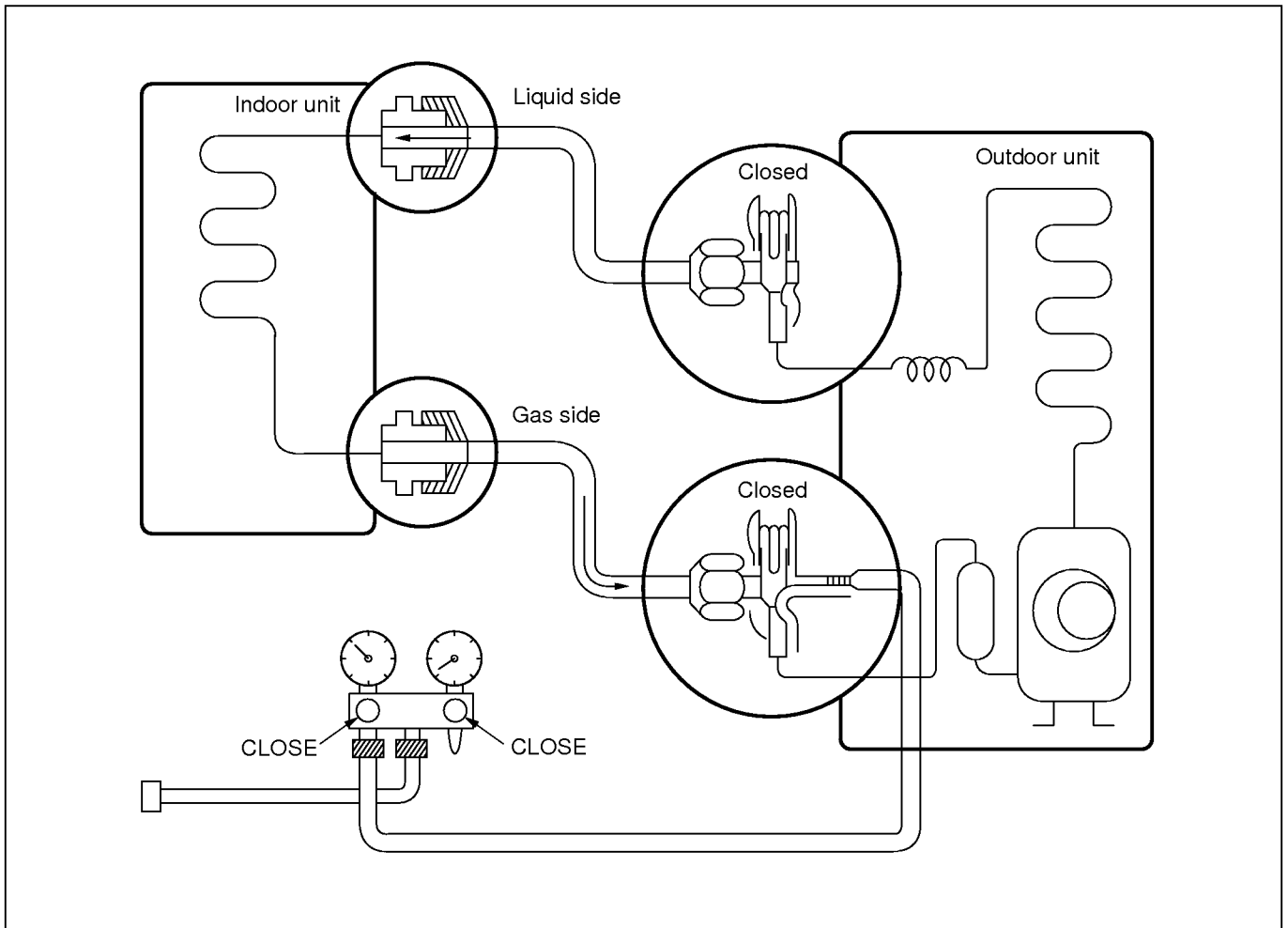

NOTE:

The additional gas for air purging has been charged in the outdoor unit.

However, if the flare connections have not been done correctly and there gas leaks, a gas cylinder and the charge set will be needed.

CAUTION : Do not leak the gas in the air during air purging. Use vacuum pump as far as possible.

6. Test running

1) Connection of power supply

1. Connect the power supply cord to the independent power supply.

- Circuitbreaker is required.

2. Prepare the remote control.

- Insert two batteries provided.
Remove the cover from the back of the remote control.
- Slide the cover according to the arrow direction.
Insert the two batteries.
(Two "R03" or "AAA" dry-cell batteries or equivalent.)
- Be sure that the (+) and (-) directions are correct.
- Be sure that both batteries are new.
Re-attach the cover.
- Slide it back into position.

3. Operate the unit for fifteen minutes or more.

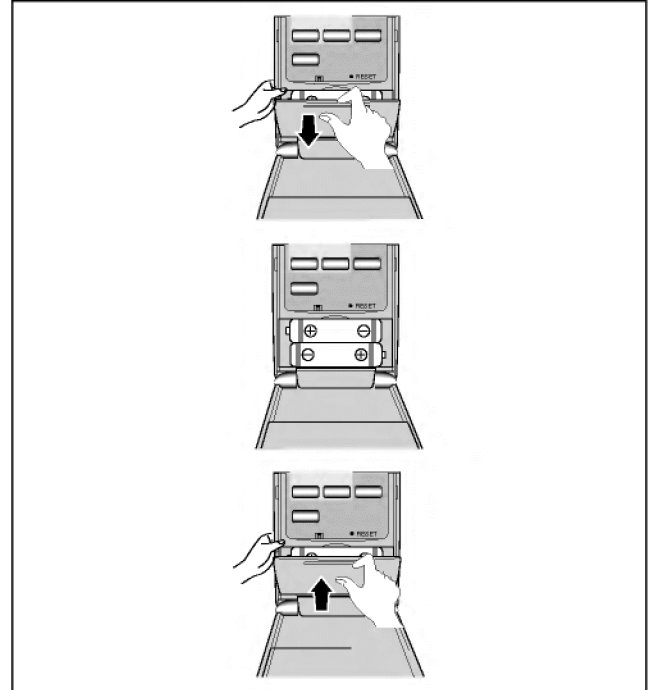

CAUTION:

This appliance must be installed in accordance with current National Wiring Regulations. Connecting cable between indoor unit and outdoor unit shall be approved and the size of conductor shall be in accordance with local law.

Settlement of Outdoor Unit

- Anchor the outdoor unit with a bolt and nut ($\varnothing 10\text{cm}$) tightly and horizontally on a concrete or rigid mount.
- When installing on the wall, roof or rooftop, anchor the mounting base securely with a nail or wire assuming the influence of wind and earthquake.
- In the case when the vibration of the unit is conveyed to the house, settle the unit with an anti-vibration rubber.

2) Evaluation of the performance

1. Measure the temperature of the intake and discharge air.
2. Ensure the difference between the intake temperature and the discharge one is more than $8\text{ }^{\circ}\text{C}$ (Cooling) or reversely (Heating).

