

This Owner's Manual is provided and hosted by [Appliance Factory Parts](#).



# LG EXV1511W Owner's Manual

[Shop genuine replacement parts for LG EXV1511W](#)

## DOOR PARTS

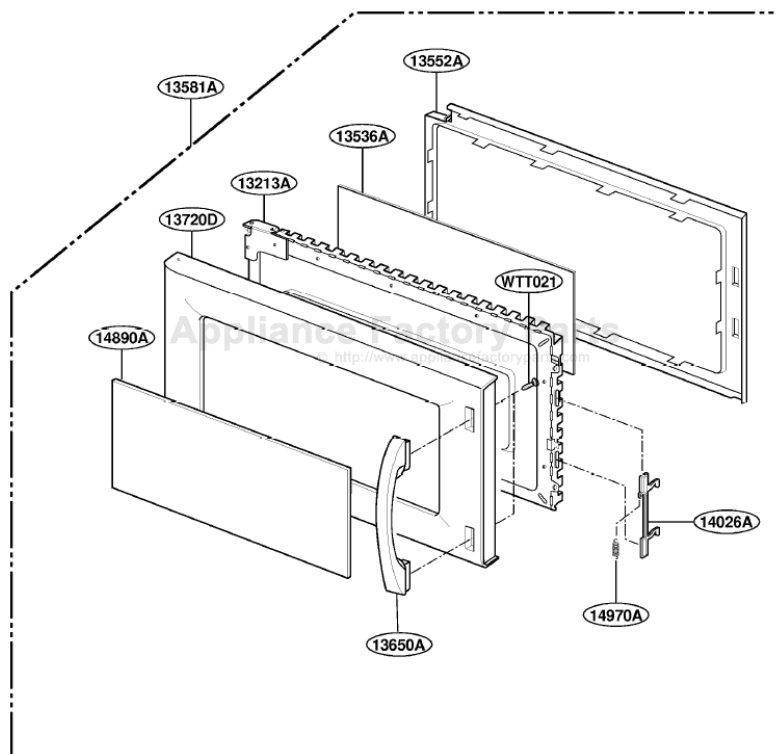

[Find Your LG Microwave Parts - Select From 955 Models](#)

----- Manual continues below -----

# EXPLODED VIEW

## DOOR PARTS

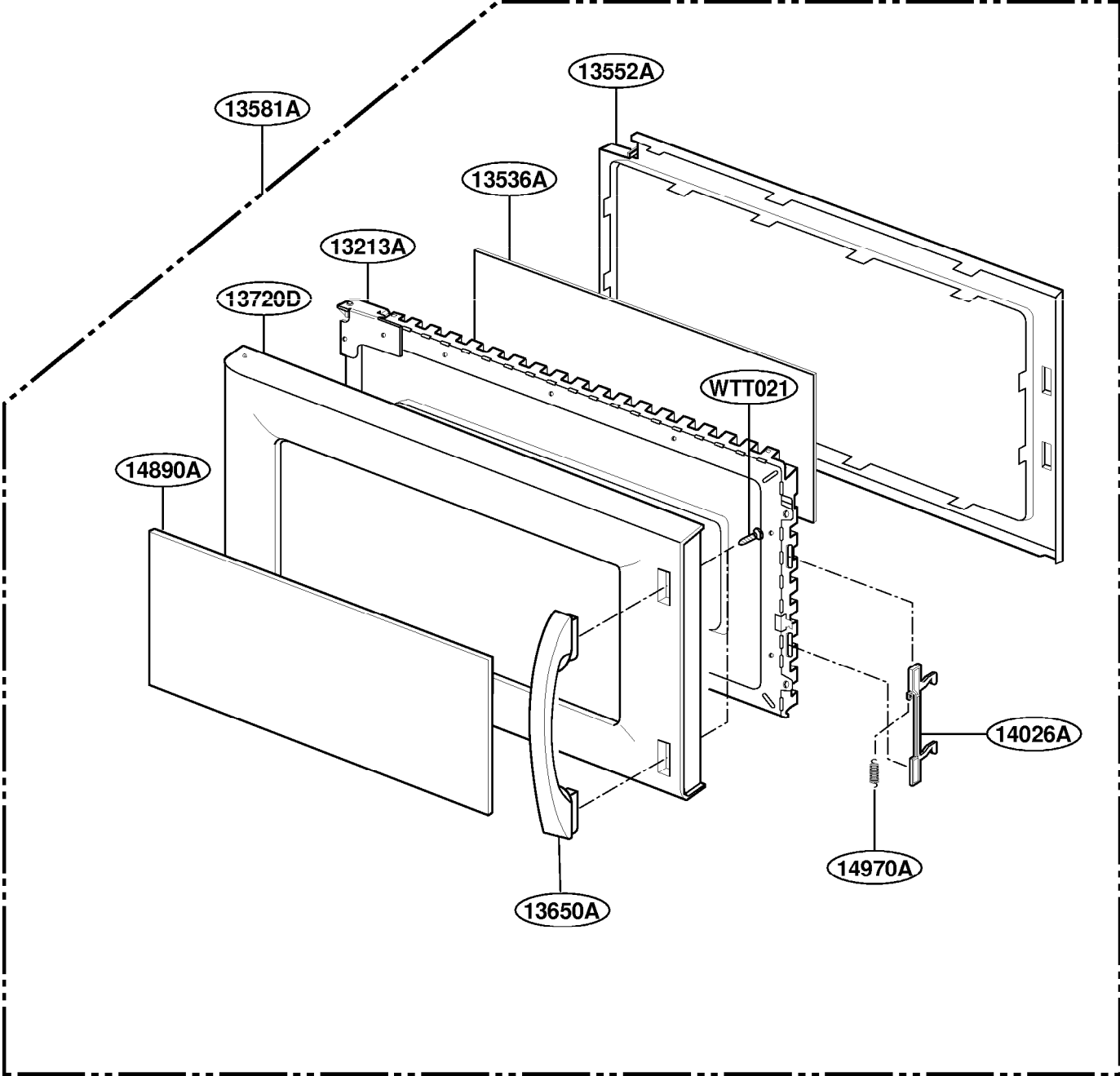

# CONTROLLER PARTS

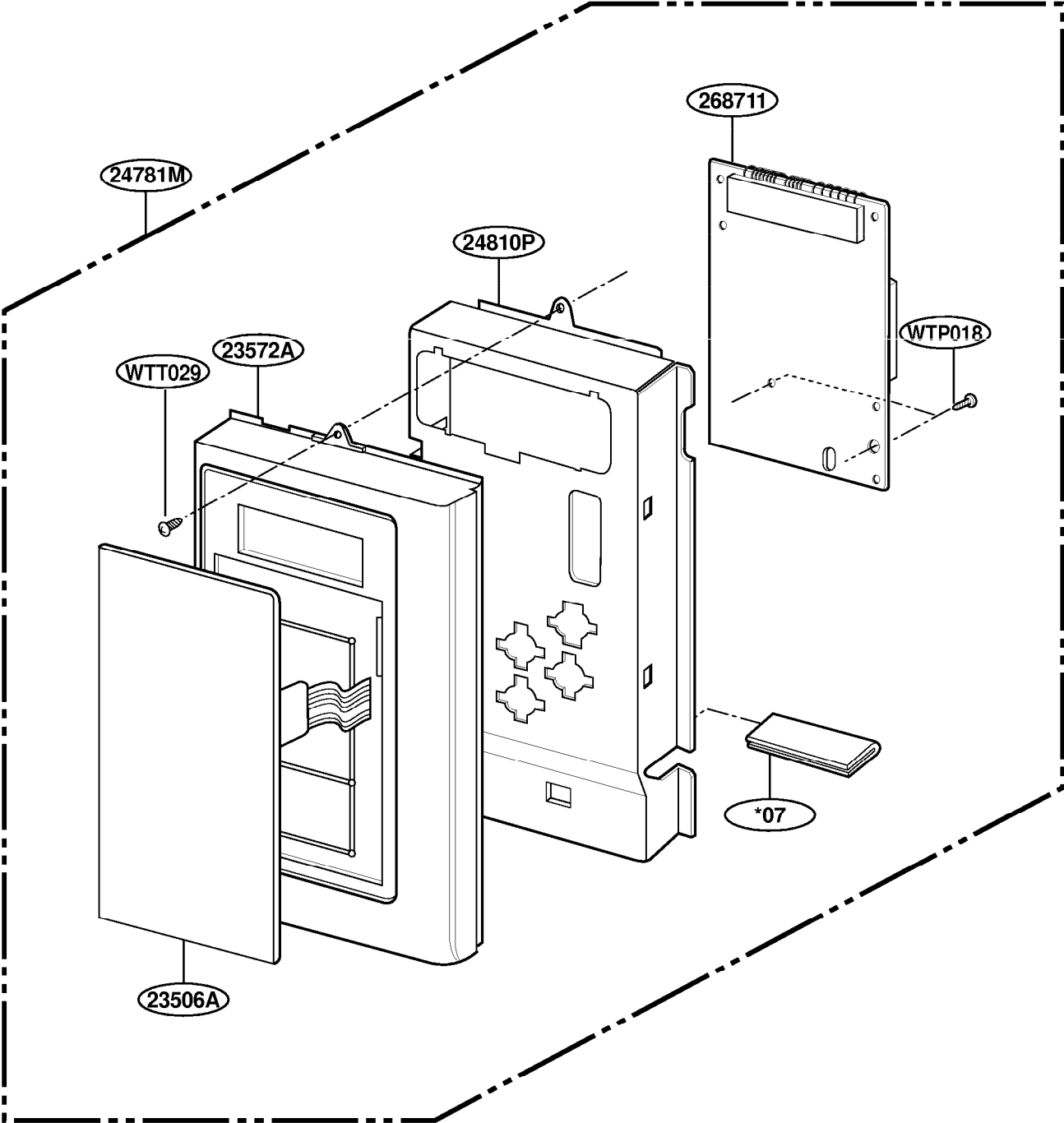

# OVEN CAVITY PARTS

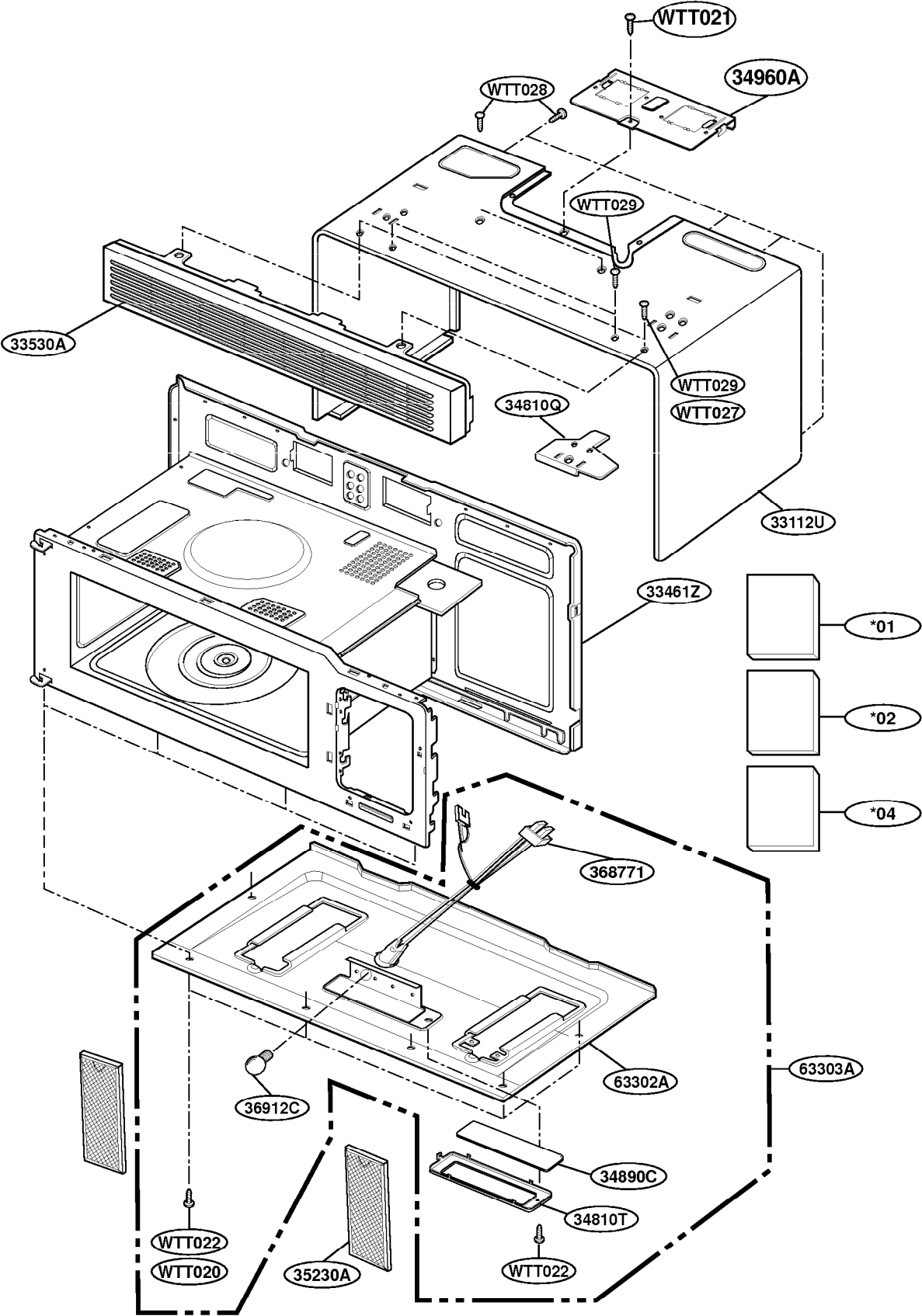

# LATCH BOARD PARTS

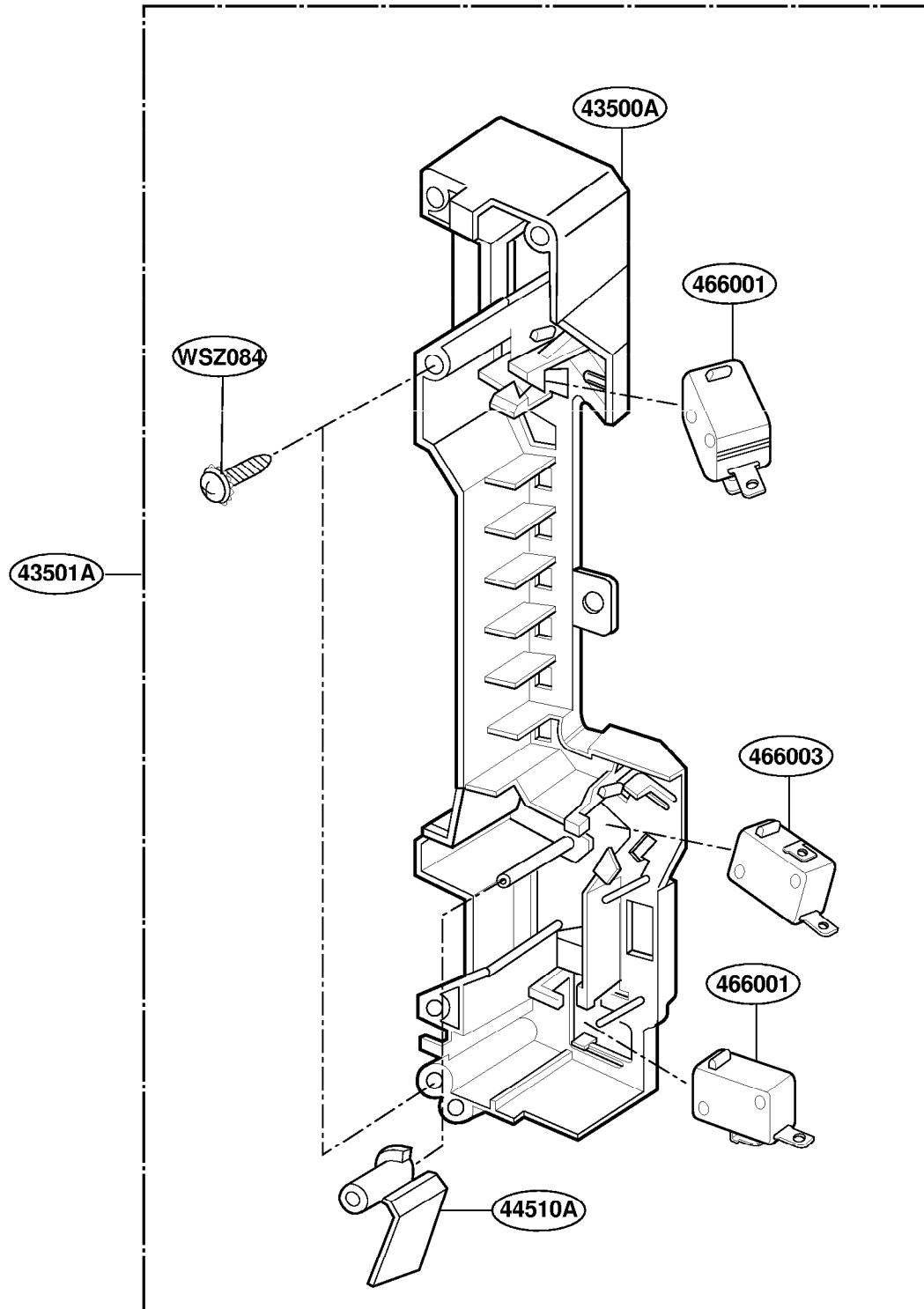

# INTERIOR PARTS(I)

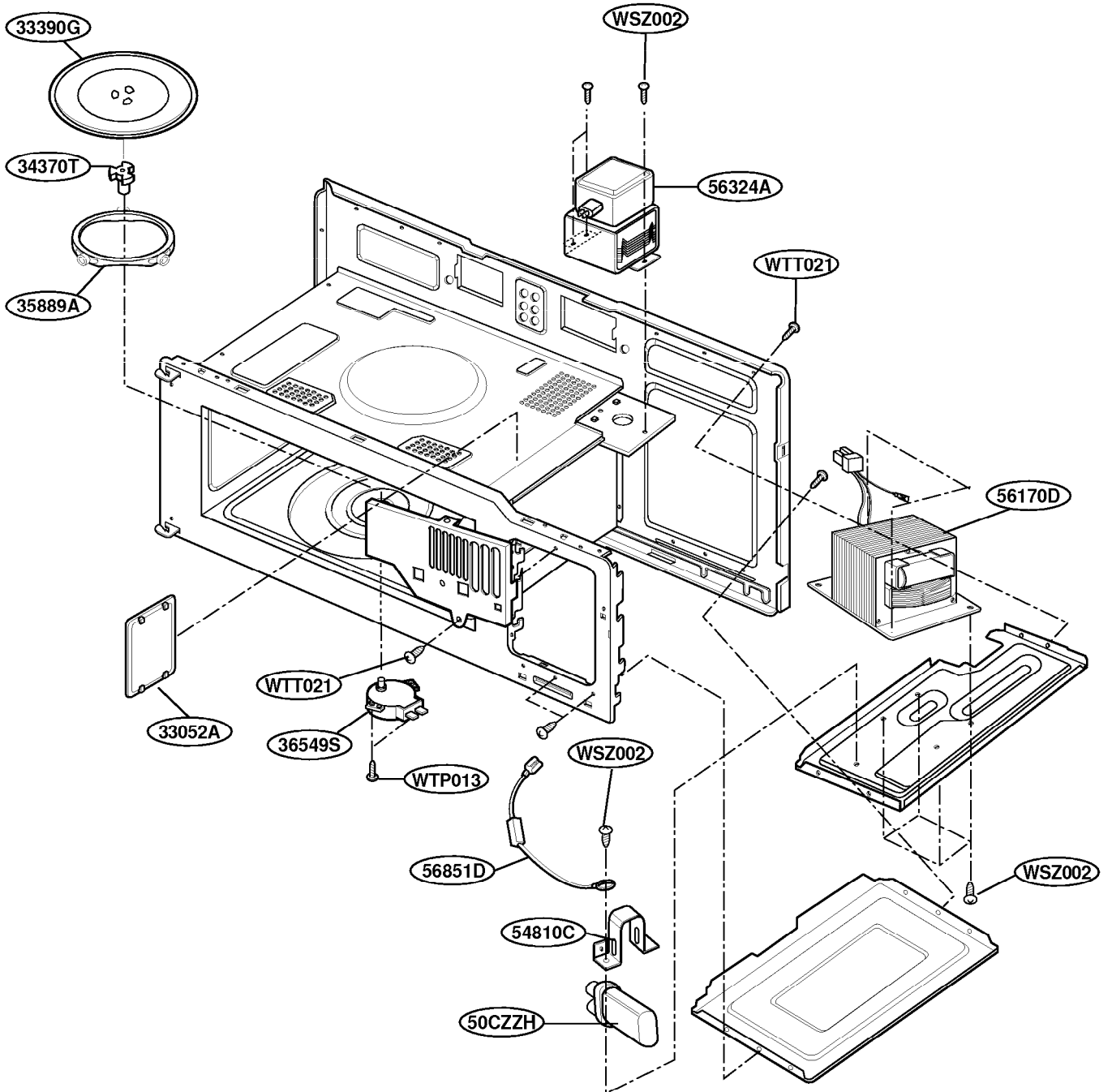

# INTERIOR PARTS (II)

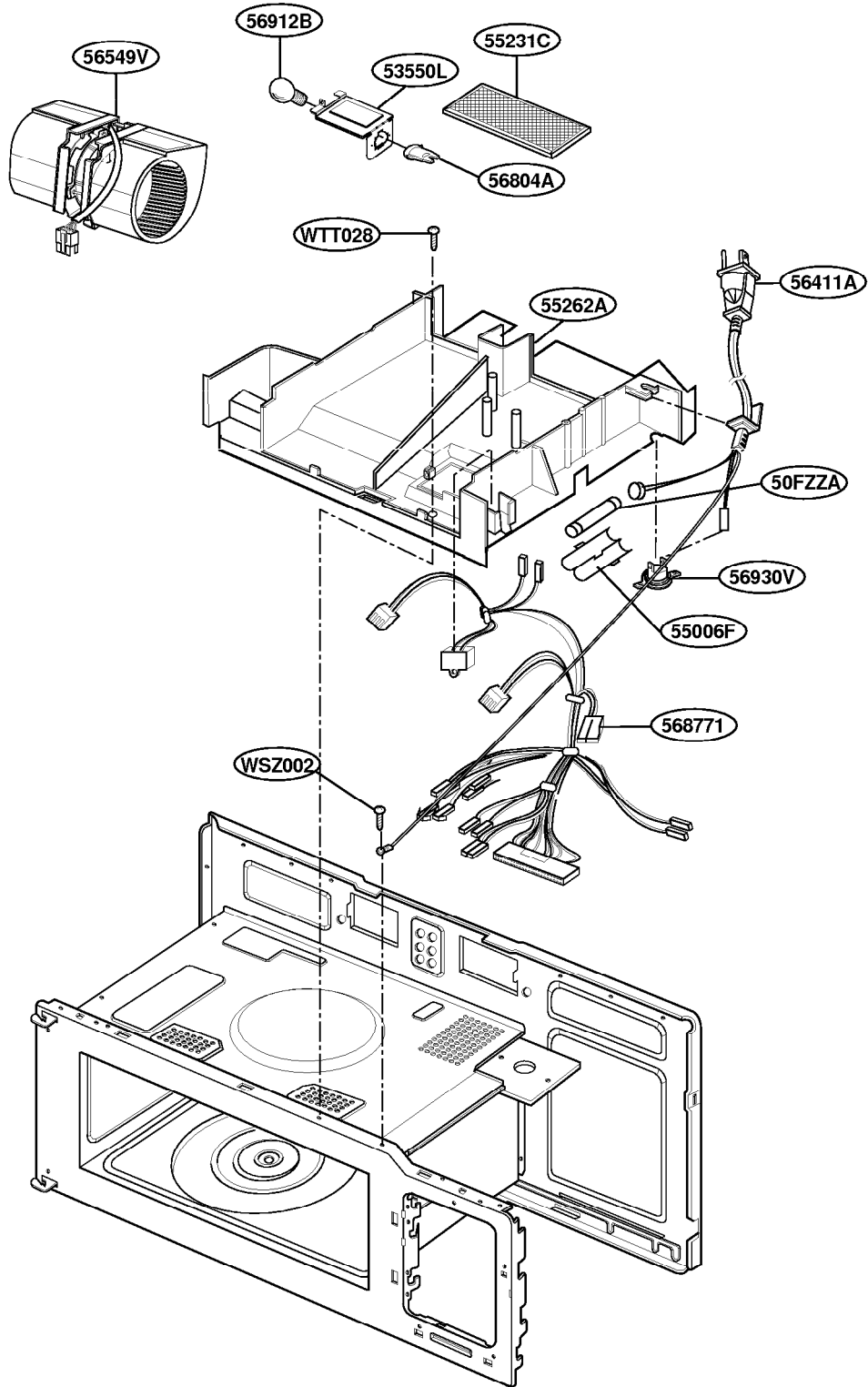

# INSTALLATION PARTS

