

This Owner's Manual is provided and hosted by [Appliance Factory Parts](#).



LG LW-B0960CL Owner's Manual

[Shop genuine replacement parts for LG LW-B0960CL](#)



[Find Your LG Air Conditioner Parts - Select From 2328 Models](#)

----- Manual continues below -----

CONTENTS

1. PREFACE

1.1 SAFETY PRECAUTIONS	2
1.2 INSULATION RESISTANCE TEST	2
1.3 SPECIFICATIONS	3
1.4 FEATURES	6
1.5 CONTROL LOCATIONS	6

2. DISASSEMBLY INSTRUCTIONS

2.1 MECHANICAL PARTS	8
2.1.1 FRONT GRILLE	8
2.1.2 CABINET	8
2.1.3 CONTROL BOX	8
2.2 AIR HANDLING PARTS	9
2.2.1 AIR GUIDE	9
2.2.2 BLOWER	9
2.2.3 FAN, SHROUD	10
2.3 ELECTRICAL PARTS	10
2.3.1 OVERLOAD PROTECTOR	10
2.3.2 COMPRESSOR	10
2.3.3 CAPACITOR	11
2.3.4 POWER CORD	11
2.3.5 THERMOSTAT	11
2.3.6 ROTARY SWITCH	11
2.3.7 MOTOR	12

2.4 REFRIGERATING CYCLE	12
2.4.1 CONDENSER	12
2.4.2 EVAPORATOR	12
2.4.3 CAPILLARY TUBE	13

3. INSTALLATION

3.1 SELECT THE BEST LOCATION	15
3.2 HOW TO INSTALL	15
3.2.1 WHEN USING GASKET	15
3.2.2 WHEN USING INSTALLATION KITS	15

4. TROUBLE SHOOTING GUIDE

4.1 OUTSIDE DIMENSIONS	19
4.2 PIPING SYSTEM	20
4.3 TROUBLE SHOOTING GUIDE	21

5. SCHEMATIC DIAGRAM

5.1 CIRCUIT DIAGRAM	26
5.2 ELECTRONIC CONTROL DEVICE	31
5.3 COMPONENTS LOCATION (OF MAIN P.C.B. ASM)	32
5.4 COMPONENTS LOCATION (FOR DISPLAY P.C.B ASM)	32

6. EXPLODED VIEW

7. SVC PARTS LIST

1. PREFACE

This SERVICE MANUAL provides various service information, the mechanical and electrical parts, etc. This room air conditioner was manufactured and assembled under a strict quality control system.

The refrigerant is charged at the factory. Be sure to read the safety precautions prior to servicing the unit.

1.1 SAFETY PRECAUTIONS

1. When servicing the unit, set the ROTARY SWITCH or POWER SWITCH to OFF and unplug the power cord.
2. Observe the original lead dress.
If a short circuit is found, replace all parts which have been overheated or damaged by the short circuit.
3. After servicing the unit, make an insulation resistance test to protect the customer from being exposed to shock hazards.

1.2 INSULATION RESISTANCE TEST

1. Unplug the power cord and connect a jumper between 2 pins (black and white).
2. The grounding conductor (green or green & yellow) should be open.
3. Measure the resistance value with an ohm meter between the jumpered lead and each exposed metallic part on the equipment at all the positions (except OFF or O) of the ROTARY SWITCH.
4. The value should be over 1M Ω .

1.3 SPECIFICATIONS

1.3.1 FOR LW-B0811CL, LW-B0810CL, LW-B0712CL

MODELS		LW-B0811CL	LW-B0810CL	LW-B0712CL
POWER SUPPLY		1ϕ, 115V, 60Hz		
COOLING CAPACITY	(Btu/h)	8,000	8,000	7,000
INPUT	(W)	800	885	760
RUNNING CURRENT	(A)	7.0	7.8	7.0
E.E.R	(Btu/W.h)	10.0	9.0	9.2
OPERATING TEMPERATURE	INDOOR (°C)	26.7 (DB) ^{fT} 19.4 (WB) ^{fT}		
	OUTDOOR (°C)	35 (DB) 23.9 (WB)		
REFRIGERANT (R-22) CHARGE		415g (14.6Oz)		320g (11.3Oz)
EVAPORATOR		2 ROW 14 STACKS, S-FIN(LG-SLIT) TYPE		
CONDENSOR		2 ROW 16 STACKS, S-FIN(LG-LOUVER) TYPE		
FAN, INDOOR		BLOWER		
FAN, OUTDOOR		PROPELLER TYPE FAN WITH SLINGER-RING		
FAN SPEEDS, FAN/COOLING		2/2		
FAN MOTOR		6 POLES		
OPERATION CONTROL		ROTARY SWITCH		
ROOM TEMP. CONTROL		THERMOSTAT		
AIR DIRECTION CONTROL		HORIZONTAL LOUVER (RIGHT & LEFT)		
		VANE (UP & DOWN)		
CONSTRUCTION		SLIDE IN-OUT CHASSIS		
PROTECTOR	COMPRESSOR	OVERLOAD PROTECTOR		
	FAN MOTOR	INTERNAL THERMAL PROTECTOR		
POWER CORD		1.8m (7') (3 WIRE WITH GROUding)		
		ATTACHMENT PLUG (CORD-CONNECTED TYPE)		
DRAIN SYSTEM		SPLASHED BY FAN SLINGER		
NET WEIGHT	(lbs/kg)	71/32		
OUTSIDE DIMENSION (W ; H ; D)	(inch)	20 ¹ / ₁₆ " ; 13 ⁷ / ₈ " ; 19 ³ / ₁₆ "		
	(mm)	510 ; 353 ; 487		

^{fT} DB : dry bulb

^{fT} WB : wet bulb

1.3.2 FOR LW-B0760CL, LW-B0960CL

ITEMS \ MODELS		LW-B0820CL	LW-B0760CL	LW-B0960CL
POWER SUPPLY		1ϕ, 220V~, 60Hz	1ϕ, 220-240V~, 50Hz	
COOLING CAPACITY	(Btu/h)	8,000	7,000	9,000
INPUT	(W)	720	775	1,000
RUNNING CURRENT	(A)	3.4	3.4	4.4
E.E.R	(Btu/W.h)	11.0	9.0	9.0
OPERATING TEMPERATURE	INDOOR (°C)	27 (DB) 19 (WB)		
	OUTDOOR (°C)	35 (DB) 24 (WB)		
REFRIGERANT (R-22) CHARGE		380g(13.4Oz)	325g (11.5Oz)	445g (15.7Oz)
EVAPORATOR		2 ROW 14 STACKS, S-FIN(LG-SLIT) TYPE		
CONDENSOR		2 ROW 16 STACKS, S-FIN(LG-LOUVER) TYPE		
FAN, INDOOR		BLOWER		
FAN, OUTDOOR		PROPELLER TYPE FAN WITH SLINGER-RING		
FAN SPEEDS, FAN/COOLING		2/2		
FAN MOTOR		6 POLES		
OPERATION CONTROL		ROTARY SWITCH		
ROOM TEMP. CONTROL		THERMOSTAT		
AIR DIRECTION CONTROL		HORIZONTAL LOUVER (RIGHT & LEFT)		
		VANE (UP & DOWN)		
CONSTRUCTION		SLIDE IN-OUT CHASSIS		
PROTECTOR	COMPRESSOR	OVERLOAD PROTECTOR		
	FAN MOTOR	INTERNAL THERMAL PROTECTOR		
POWER CORD		1.8m (7') (3 WIRE WITH GROUING)		
		ATTACHMENT PLUG (CORD-CONNECTED TYPE)		
DRAIN SYSTEM		SPLASHED BY FAN SLINGER		
NET WEIGHT	(lbs/kg)	71/32		
OUTSIDE DIMENSION (W ; H ; D)	(inch)	20 ¹ / ₁₆ " ; 13 ⁷ / ₈ " ; 19 ³ / ₁₆ "		
	(mm)	510 ; 353 ; 487		

1.3.3 FOR LW-B0713CL, LW-B0961CL

ITEMS		MODELS	LW-B0713CL	LW-B0961CL
POWER SUPPLY			1ø", 110V, 60Hz	1ø", 220-240V~, 50Hz
COOLING CAPACITY (Btu/h)			7,142	9,000
INPUT (W)			790	1,000
RUNNING CURRENT (A)			7.2	4.4
E.E.R (Btu/W.h)			9.0	9.0
OPERATING TEMPERATURE	INDOOR (°C)		27 (DB) 19.5 (WB)	27 (DB) 19 (WB)
	OUTDOOR (°C)		35 (DB) 24 (WB)	35 (DB) 24 (WB)
REFRIGERANT (R-22) CHARGE			320g (11.3Oz)	445g (15.7Oz)
EVAPORATOR			2 ROW 14 STACKS, S-FIN(LG-SLIT) TYPE	
CONDENSOR			2 ROW 16 STACKS, S-FIN(LG-LOUVER) TYPE	
FAN, INDOOR			BLOWER	
FAN, OUTDOOR			PROPELLER TYPE FAN WITH SLINGER-RING	
FAN SPEEDS, FAN/COOLING			2/2	
FAN MOTOR			6 POLES	
OPERATION CONTROL			REMOTE CONTROL	
ROOM TEMP. CONTROL			THERMISTOR	
AIR DIRECTION CONTROL			HORIZONTAL LOUVER (RIGHT & LEFT)	
			VANE (UP & DOWN)	
CONSTRUCTION			SLIDE IN-OUT CHASSIS	
PROTECTOR	COMPRESSOR		OVERLOAD PROTECTOR	
	FAN MOTOR		INTERNAL THERMAL PROTECTOR	
POWER CORD			1.8m (7') (3 WIRE WITH GROUING)	
			ATTACHMENT PLUG (CORD-CONNECTED TYPE)	
DRAIN SYSTEM			SPLASHED BY FAN SLINGER	
NET WEIGHT (lbs/kg)			71/32	
OUTSIDE DIMENSION (W ; H ; D)		(inch)	20 ¹ / ₁₆ " ; 13 ⁷ / ₈ " ; 19 ³ / ₁₆ "	
		(mm)	510 ; 353 ; 487	

1.4 FEATURES

- Designed for COOLING ONLY.
- Power and whisper cooling.
- Slide-in and slide-out chassis for simple installation and service.
- Side air-intake, side cooled-air discharge.
- Built-in adjustable THERMOSTAT.
- Washable one-touch filter.
- Compact size.
- Reliable and efficient rotary compressor is equipped.

1.5 CONTROL LOCATIONS

1.5.1 COOLING ONLY MODEL

• VENTILATION

The ventilation lever must be in the CLOSE position in order to maintain the best cooling conditions.

When fresh air is necessary in the room, set the ventilation lever to the OPEN position.

The damper is opened and room air is exhausted.

NOTE

Before using the ventilation feature, make a ventilation kit. First pull down part ε to horizontal line with part ε .

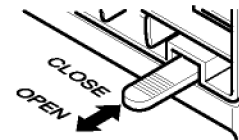

CLOSE ← VENT → OPEN

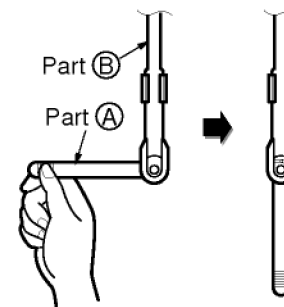

• ENERGY SAVER

Energy saver provides more energy efficient operation of the air conditioner by cycling the fan on and off with compressor.

REGULAR : Energy saver is not operated.

ECONOMY : Energy saver is operated.

(FOR LW-B0811CL)

• THERMOSTAT

Thermostat will automatically control the temperature of the room. Select a higher number for a cooler temperature in the room. The temperature is selected by positioning the knob to the desired position.

The 5 or 6 position is a normal setting for average conditions.

• OPERATION

OFF (0) : Turns the air conditioner off.

HIGH FAN (⊗) : High fan speed operation without cooling.

LOW FAN (⊕) : Low fan speed operation without cooling.

HIGH COOL (❄) : Cooling with the high fan speed operation.

LOW COOL (❄) : Cooling with the low fan speed operation.

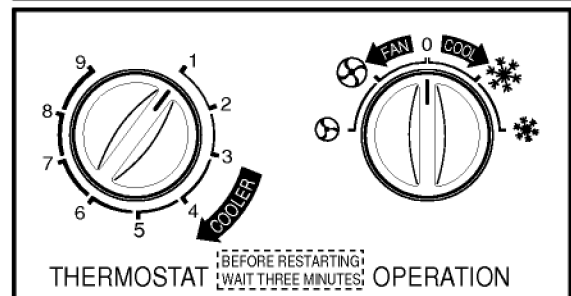
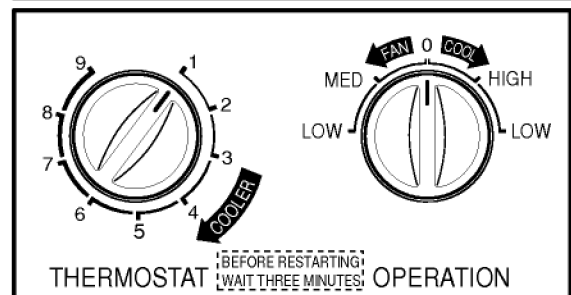
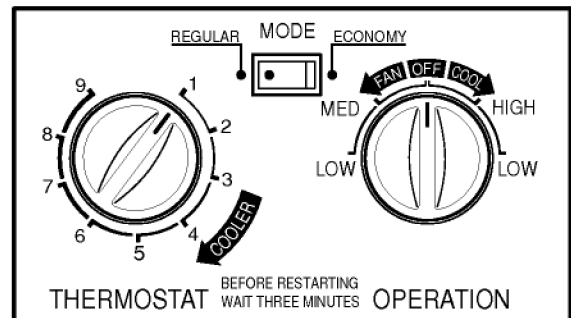

1.5.2 COOLING ONLY MODEL WITH REMOTE CONTROL

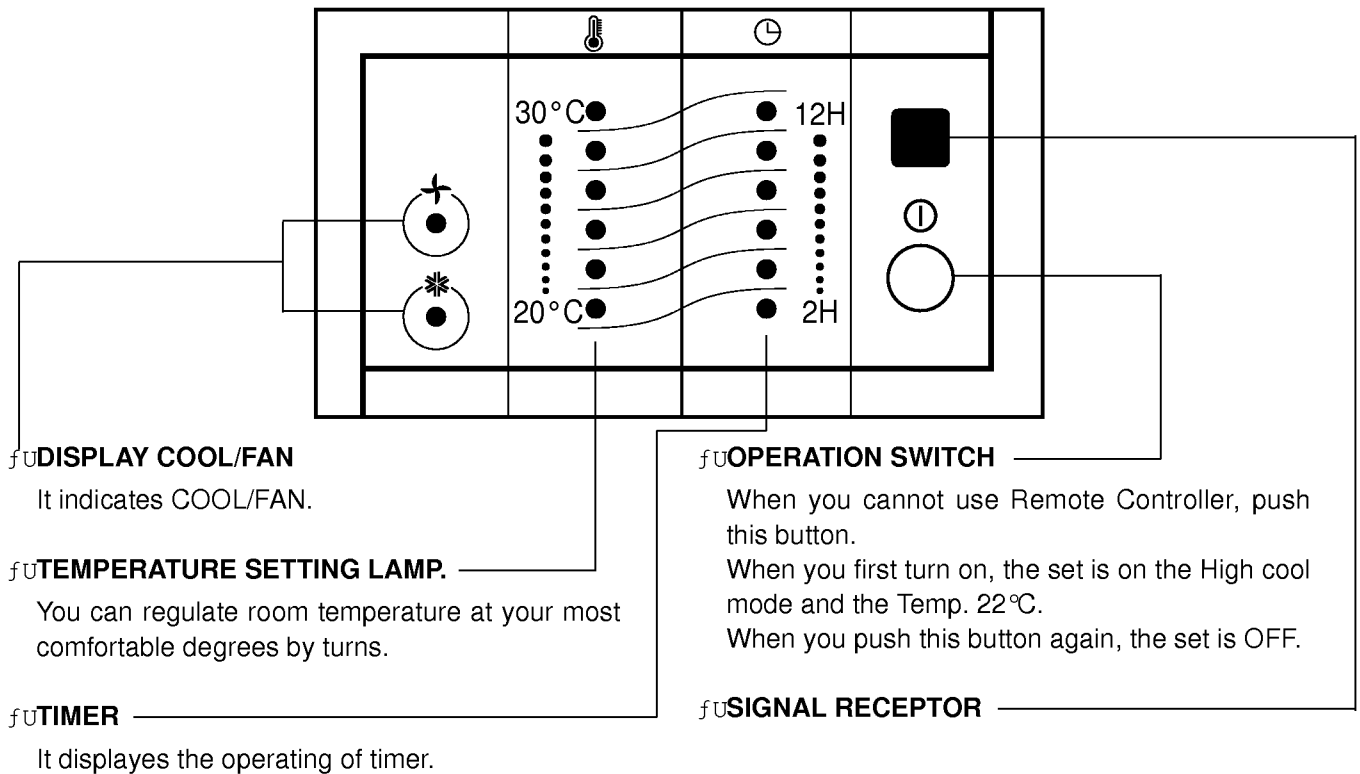

fU REMOTE CONTROL

Precaution: The Remote Control unit will not function properly if strong light strikes the sensor window of the air conditioner or if there are obstacles between the Remote Control unit and the air conditioner.

