

This Owner's Manual is provided and hosted by [Appliance Factory Parts](#).



ULTRAVATION 92-036 Owner's Manual

[Shop genuine replacement parts for ULTRAVATION
92-036](#)



[Find Your ULTRAVATION Air Cleaner Parts - Select From 378 Models](#)

----- Manual continues below -----

Ultravation®

Professional Indoor Air Quality Products

Photronic Complete Whole House Air Cleaning System OWNERS GUIDE



Models: Straight Through Design and Slimline Design

Table of Contents:

- Page 2- Shipping and Packaging list, Introduction and Application, Safety Precautions, Power Consumption, Installation Requirements
- Page 3- Typical Mounting Positions, Installation of Electric Power Supply
- Page 4- Germicidal Lamp Installation
- Page 5- Maintenance, Replacing Filter
- Page 6- Setting the Lamp Status Indicator, Replacing Photocatalytic Lamps, Replacing Germicidal Lamps
- Page 7- Troubleshooting, Setting Indicator Light
- Page 8- Applications with Humidifiers, Air Conditioners, Transitions
- Page 9- Warranty, Replacement Part Numbers

LEAVE FOR HOMEOWNER

Shipping and Packaging List:

- Filter Housing including Access Door
- Merv 11 Media Air Filter
- PCO Filter
- Electrical Enclosure
- 1- UVA Lamp
- 1- UV Status view port
- 12- ¾ inch 5/16 self tapping sheet metal screws
- 4- 1 inch UVC lamp mounting screws
- 2- UVC Lamp Mounting Plates
- *2- UVC Lamps Part:
 12" UVC lamp option
 OR
 17" UVC lamp option

* Included when UVC option is purchased

Introduction and Applications:

This Ultravation Photronic Straight Through Media Air Cleaner is a complete whole house air cleaning system. This high efficiency air filtration unit is designed to remove dirt, dust, pollen, and microscopic particles: reduce unpleasant odors, VOC gases and the microbial population from the air that circulates through it. By adding this device to your HVAC system, you are helping to create a cleaner indoor living environment for your whole household.

The system works in 2-3 steps (depending on model purchased, some models do not include the germicidal protection in step 3)

STEP 1: Trapping particles in the pleats of the MERV 11 media filter. With an extra large surface area, the filter allows for maximum dirt holding capacity and a long, useful filter life with minimum air flow restriction.

STEP 2: VOC's and gases such as the fumes from new carpets, paints, nail polish, cigar and cigarette smoke are drastically reduced photo chemically via a patented process known as photocatalytic conversion or photocatalytic oxidation.

(Option)**STEP 3:** Germicidal UVC light is applied to the Air to drastically reduce or eliminate unwanted virus, bacteria and mold.

This air cleaner is to be installed in a forced air heating, cooling and ventilation system. It should be installed so that all the system's air is circulated through the filter first and VOC Section second. The air cleaner will only filter the air that is circulated through it. For maximum filtration effect, set your blower to operate continuously. (Lower speeds allow for higher efficiency)

Safety Precautions:

It is recommended that this unit be installed and maintained by a trained technician:

WARNING: UV Hazard. Always protect eyes from ultraviolet light. NEVER look at UV lamps in operation. Unplug or disconnect power before re-lamping or servicing.

WARNING: Severe eye damage or temporary blinding may occur.

WARNING: DO NOT operate UVC lamps outside of Air Handler. Mount lamp base to duct first.

WARNING: No openings in duct are allowed which would give direct line-of-sight to the UV light.

In the event of accidental breakage or replacement of the ultraviolet lamp, please ensure that the lamp is disposed of in accordance with local and state environmental laws regarding fluorescent lamps containing mercury.

Notice:

All wiring inside of the duct or air handling system in direct line of site of the UV lamp must be shielded with aluminum foil tape or equivalent non-combustible material. When installing this unit, select a mounting location that prevents ultraviolet light exposure to plastic flexible duct liner or other plastic components with unknown resistance to ultraviolet light. Ultraviolet light may cause color shift or structural degradation of plastic HVAC components

Power Consumption UV-A, UV-C lamps

<u>Lamp Type</u>	<u>Quantity Required</u>
16-inch UV-A lamp is 36 watts	1
12-inch UVC lamp is 12 watts each	2
17-inch UVC lamp is 22 watts each	2

Installation requirements:

This unit is designed to be powered up constantly and should not cycle on and off with a blower motor.

Unit must be installed either within 6 feet of a 120 power outlet, or hardwired per local and state electrical code (Range 120-277VAC).

There must be at least 16 inches on top of the unit for lamp replacement.

There must be minimum 26 inches in front of the door for filter replacement.

Installation – Filter Housing Cabinet

Ultravation Photronic Air Cleaning Systems can be installed horizontally, vertically, even at an angle. The air cleaner is also designed to be internally reversible with the airflow direction. They must be installed in an area of the duct that precedes the blower compartment. In this location, the blower motor and internal components will be kept clean. This increases air handler component life, improves system efficiency, and reduces maintenance costs.

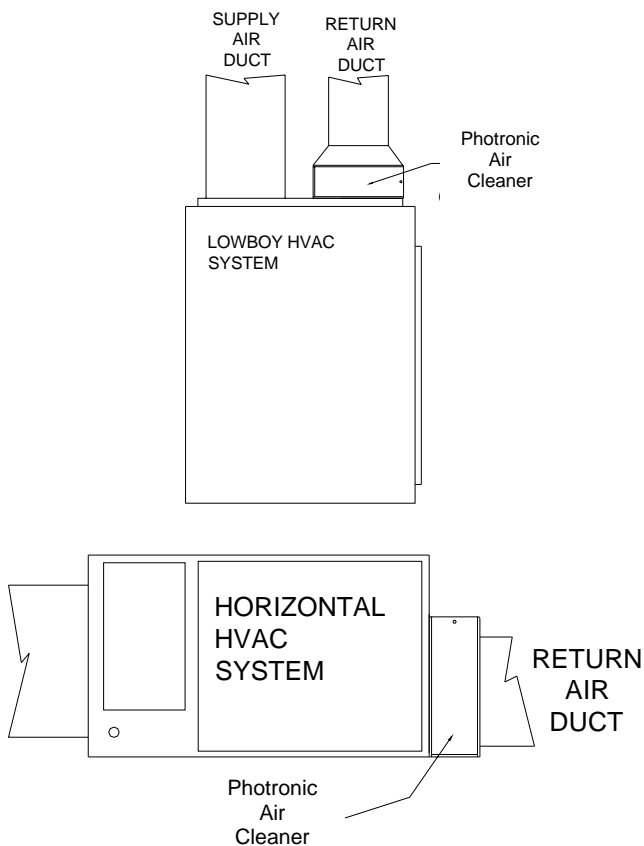
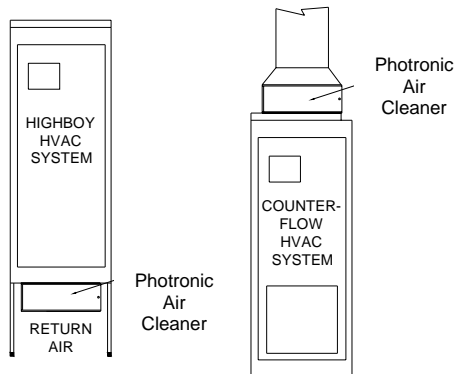

The Ultravation Straight Through Air Cleaner has been designed for use in conjunction with virtually any HVAC system.

Do not install this unit in the supply duct.

Be sure to plan adequate space for filter replacement.

Before installation is complete, seal all joints and seams with duct tape or caulking.

Installation of Electronic Power Supply:

1. Determine the desired airflow path for installation and install MERV 11 filter and PCO filter. (This will determine the placement of the electrical enclosure on the wide units – remove the knockout from the housing)
2. Remove the cover from the electrical box.
3. Line up the lamp hole in the electrical enclosure with the knockout on the filter housing and screw electrical housing into place with provided hardware.
4. Install the twin tube (white in color) photocatalytic lamp. When installed it is parallel to the Mesh filter.
5. The photocatalytic lamp clips into the socket with diagonal pressure then seat back into place. (See Illustration on page 6)
6. See instructions on setting the indicator light on models utilizing UVC lamps. (page 6).
7. Reinstall the electrical cover.

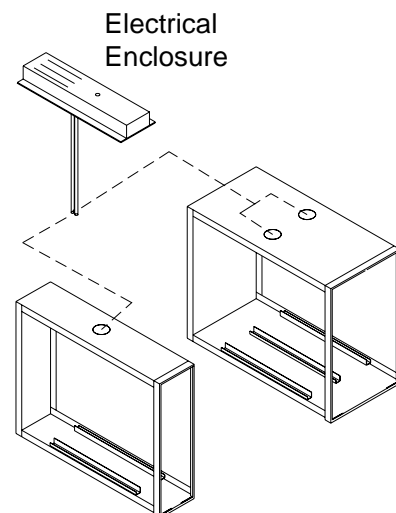

UV-C Germicidal Lamp, Stage 3, Installation steps for Models with UVC option.

UV-C Germicidal Stage 3 is designed for installation in the HVAC (heating, ventilation, and air conditioning) system.

The optimum installation location for UV-C Germicidal Stage 3 lamp is in the supply side ductwork exiting the HVAC system before the ductwork branches.

The UV unit should already be installed in the previous step; the UVC lamps should be centrally located within the air handler and positioned to achieve maximum reduction of airborne pathogens.

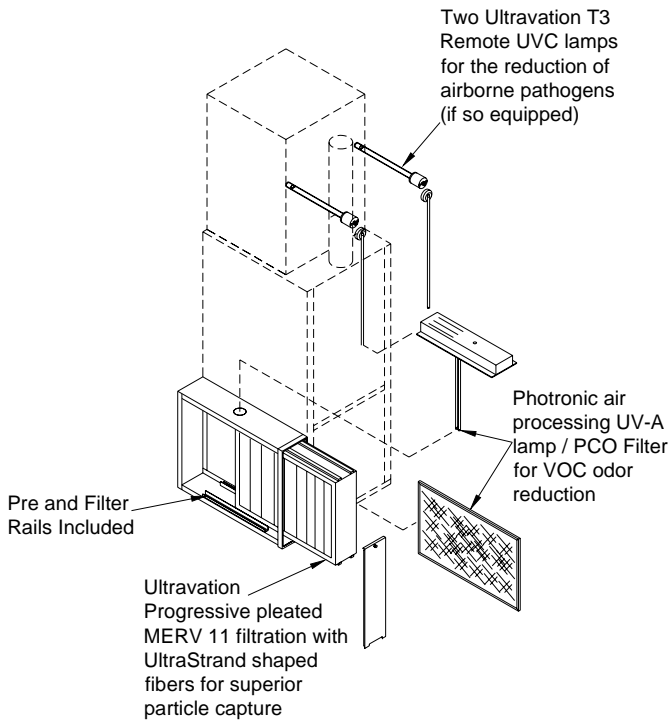

Note:

This Photronic System and the UV-C lamps are designed to operate constantly and should not cycle on and off with a blower motor. Installation in a return air duct is acceptable but not recommended in a high dust environment.

Do not allow the UVC light to shine on the MERV 11 filter. The UVC energy will decompose the filter within 120 days.

It is recommended a trained technician install this unit. Never look at the UV lights without proper eye protection.

Installation steps:

1. Determine a suitable location to install the UV-C Lamps.
2. Select a location for the remote UV lamp module assembly. Drill a 1" diameter hole for each lamp assembly. Attach lamp module assembly with 2 screws at the chosen location, or an optional lamp mounting plate, which has been supplied to mount the lamp assembly.

Note: The T3 UV lamp assembly can be removed independently, simply by removing the 2 screws in the lamp holder.

3. Plug the rubber lamp connector fully onto the installed UV lamp assembly. Be sure the 4 pinholes are orientated properly to the 4 mating pins of the lamp.

Note: the pins are in a rectangular patent and can only be mated in 2 positions. Pulling the lamp boot back will help with the visual alignment of the pins and connections. After making the connection be sure to Push lamp boot over lamp base.

See the illustration of the T3 lamp 4-pin connector.

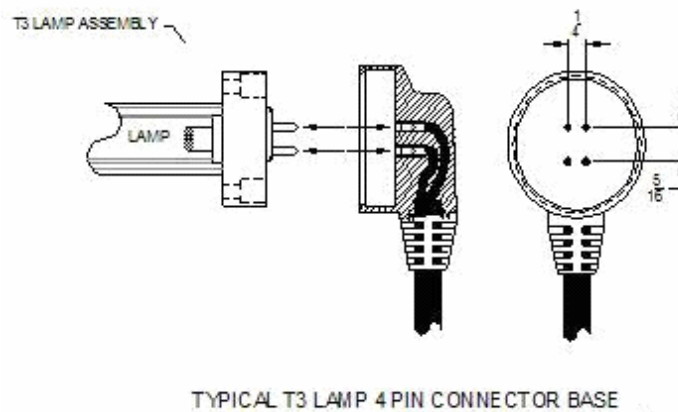
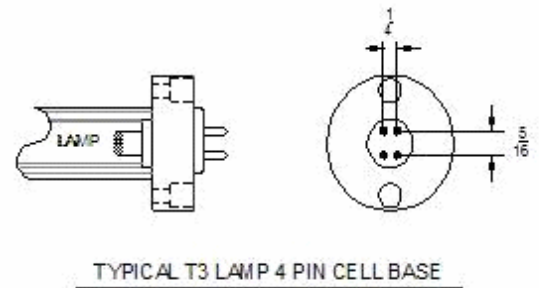

Maintenance:

The filter media in your air cleaner must be changed periodically. The frequency of filter replacement is best determined by visual examination. However, a bi-annual replacement of the 5" filter and 30 days for the 1" filter is strongly recommended. Replacement filters obtained through your installing contractor or local dealer. - Actual replacement may vary depending on the severity of dust and dirt particles.

If the Photocatalytic aluminum filter should become dirty, it may be cleaned with low velocity compressed air or vacuum only, no solvents or water should be used. If the Photocatalytic section becomes wet, allow the section to air dry before reinstallation.

The aluminum mesh screen on the Photocatalytic filter is coated using a patented process known to photochemically breakdown VOC's and Odors as well as reduce airborne pathogens on contact. Under normal operating conditions this filter should last up to 10 years.

The Air cleaner should never be run with less than a MERV-11* Filter.

Using less than a MERV-11* Filter rating will reduce the effectiveness of this product. It is recommended that this product be serviced and maintained by an HVAC professional.

*MERV or Minimum efficiency rating value is a number assigned to filters indicating their ability to capture particles and dust, the higher the number the better the filter. A MERV 11 filter is 40% more effective than a MERV-8. Be sure that an Ultravation MERV-11 filter is requested for replacements in this product.



Steps for replacing filters:

Pleated Media Filter:

1. Open the access door by pressing down on handle then pull top of door forward slightly and lift.
2. Pull out media filter and discard.
3. Slide new media filter into cabinet with "airflow label pointing in the direction of the airflow. Be sure to seat new filter into top and bottom guide rails to assure a good seal.
4. Replace access door.

Note: a gasket is provided to seal between the opening on the side of the filtration cabinet and the side of the air handler.

Aluminum PCO Filter:

Follow steps 1 and 2 above.

3. Slide new PCO filter into cabinet after media air filter in direction of airflow. Be sure to seat the new filter into both top and bottom guide rails to assure a good seal.
4. Replace access door.



Lamp Status Indicator Light(s):

UVA Lamp:

There is a round knockout in the filter door that needs to be knocked out and the included round viewport needs to be inserted into the hole.

When the unit is on, if light is detectable through the viewport than the UVA lamp is working.



UVC Lamps:

The UVA lamps and the UVC lamps should be replaced at 2 years of operation, or when indicated by the service monitor located on the Photronic cabinet. Once the indicator is set it will begin counting 9000 hours (approx. 1 year) of operation. After 9000 hrs of operation it will signal that it is time to reset the counter back to 0 and begin counting the next 9000 hours.

On startup of the equipment:

1. Depress square yellow RESET button (hold down for 10 sec.) on circuit board, the LED should turn Green while the button is depressed.
2. Release the square yellow RESET button.
3. You now have set the internal clock to zero insuring an accurate measurement of lamp life operating hours.

NOTE: When replacing lamps repeat steps above to set the clock back to 0 to begin counting the operating hours of the new lamp.

Steps for replacing Photocatalytic lamp:

1. Turn the systems power off.
2. Remove the screw(s) from the top of the electronics cabinet.
3. Remove the cover; withdraw the lamp and connector assembly (assembly does not fully remove.)
4. The connector snaps off from the lamps by applying upwards pressure on side where the wires are located.
5. Reverse the process with a new lamp.

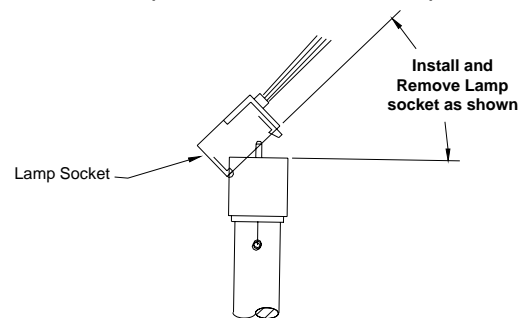

Steps for replacing UVC lamps

1. Turn the systems power off.
2. Locate the remote lamp assembly, and remove the rubber boot.
3. Remove the 2 screws from the plastic lamp base.
4. Withdraw the UVC lamp assembly from the mounting location.
5. Reverse the process with new lamps. **(New lamps should be cleaned with a damp cloth or with rubbing alcohol to remove any fingerprints and debris prior to installation.)**

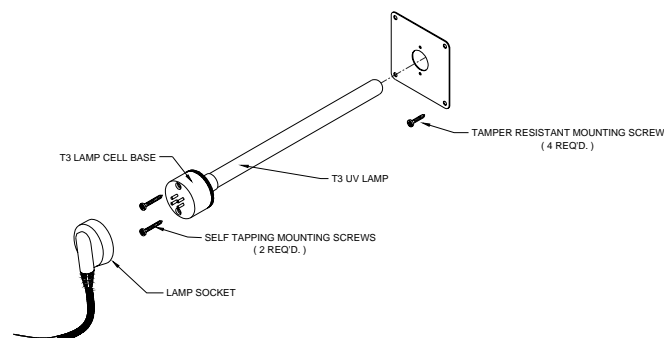

Be sure to recycle the used lamps in accordance with your local codes for fluorescent lamps. If you are not sure on how to recycle the lamps please call the Ultravation customer service line at 866-468-8247.

Troubleshooting:

Important information: It is a normal characteristic of all UV lamps to blacken around the filaments (ends) of the lamp. This does not signify the lamp is defective or not emitting Ultraviolet light.

The only time a UV lamp is defective is if it will not light. UV Lamps that illuminate will not qualify for Warranty.

Check for any loose or disconnected wiring

Lamps are securely plugged into their sockets

Verify the unit has power (120-240 volts) and the Power switch is in the ON position

The electronic circuit of a 3-lamp system only operates when both lamps are operating.

Verify 5 amp fuse is not blown by visual inspection or perform a continuity test of the fuse.

Verify what signal if any the UV Lamp Monitor LED is emitting. (See below).

Verify if in fact the UV lamps are on or off. **Do not look at the UV light without proper eye protection.**

Note: A flashing red every 5 seconds and a beep every 3 minutes does not necessarily mean the lamps are defective or no longer emitting UV; it is sensing the lamp(s) in the unit **are not on**. This could be caused by other factors.

In this case a service technician should be contacted.

Please contact your local dealer or HVAC contractor for replacement lamps.

There are **NO** user serviceable replacement parts other than the lamps.

Refer servicing to qualified service personnel.

UV-C, Lamp Status Monitor (if equipped):

LED Color	Audible Alarm	Unit Status
Green	No audible	OK
Solid Red	No Audible	Reset lamp service indicator or replace lamp within 30 days, occurs at approx. 11 months of operation
Flashing Red (Every 5 seconds)	Beep every 3 Minutes	Lamp has exceeded 1 year of operation reset or replace lamps
Pulsing Red (Every 1 second)	Beep every 1 second	UV lamp(s) are not lit. See note below.

Note: A flashing red every second and a beep every second does not necessarily mean the lamps are defective or no longer emitting UV, it is sensing the lamp(s) in the unit **are not on**. This could be caused by other factors.

In this case a service technician should be contacted.

Please contact your local dealer or HVAC contractor for replacement lamps. There are **NO** user serviceable replacement parts other than the lamp.

Refer servicing to qualified service personnel.

Service Indicator Light:

The Photronic Series incorporates an audible and visual annual service reminder indicator. A lamp status monitor on the cover provides a visual LED signal (solid GREEN) when the unit is operating correctly. Other situations are covered on the chart on page 7.

(See UV lamp monitor chart- see page 7)

To set the service indicator Light: It is recommended that a certified technician perform this operation.

1. To set or reset the annual service indicator the unit must have power to it.
2. Remove the cover from the unit.
3. Press down and hold the square yellow **RESET** button (hold down for 10 sec.) on circuit board (located adjacent to the LED on the circuit board), **the LED** should turn **GREEN** while the button is depressed.
4. Release the square yellow **RESET** button.
5. Replace the cover, and inspect operation. LED should be Green.

UV Lamp replacement:

NOTE: When replacing lamps after 1 year or 2 years of operation disconnect power to the unit first. After the lamps are in place, complete steps 1-5 to set the service indicator to 0.

For optimum 24/7 air stream disinfection it is recommend the UV-C lamp is replaced on an annual basis.

Application with a Humidifier:

The Media Air Cleaner is compatible with humidifiers. Avoid applications where water mist will reach the filter media.

When an evaporative type humidifier is used, it may be installed between the furnace warm air duct and the return air duct without affecting the air cleaner.

Atomizing and spray type humidifiers should be installed with at least 6 feet between the Air cleaner and humidifier.

Air Conditioning:

The air cleaner should be installed upstream of the cooling coil. This will keep the coil clean and reduce air conditioning coil maintenance. Improved cooling efficiency is the result, which directly affects energy costs. A clean coil will reduce utility costs.

Failure to replace media can cause damage to the cooling system.

Transitions:

If the air duct does not fit the air cleaner cabinet opening, gradual transitions are recommended to reduce air turbulence through the air cleaner and maximize efficiency. Not more than 20 degrees (about 4" per running foot) of expansion should be used on each side of the transition fitting.

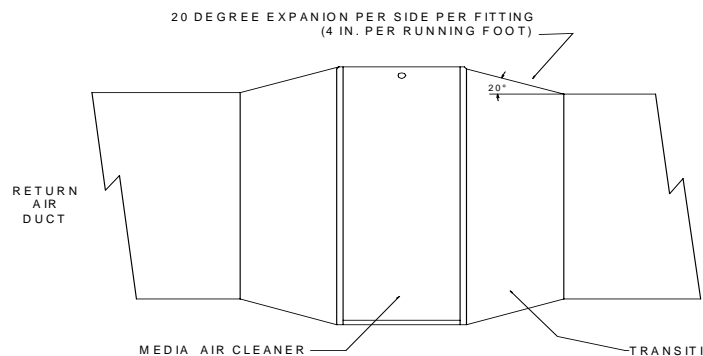

Warranty:

Ultravation warrants this product against any defects in material or workmanship for a period of 10 years after date of purchase, with the exception of the disposable media filter, the UV Lamps, the ductwork and installation. The UV lamps are warranted for a period of 1 year.

This warranty does not include damage to the unit from accident, misuse or improper installation. If this product should become defective during the warranty period, Ultravation will repair or elect to replace the product free of charge. Ultravation will return repaired or replaced warranted products pre-paid, provided that the product was delivered pre-paid.

Ultravation shall have no responsibilities for charges incurred by the customer for installation or removal of warranted items. Liability is limited only to the replacement or repair of this product.

This warranty gives you specific legal rights, and you may also have other rights, which vary from state to state. All returns must be accompanied by a return authorization number, which may be obtained by contacting Ultravation, Inc.

Ultravation, Inc. ~ P.O. Box 165 ~ 212 Ideal Way ~ Poultney, Vermont 05764
Phone: 802-287-9735 ~ Fax: 802-287-9203 ~ www.ultravation.com

Replacement Parts:

20" x 25" x 5" MERV 11 Filter p/n: **91-006**
16" x 25" x 5" MERV 11 Filter p/n: **91-005**
20" x 20" x 5" MERV 11 Filter p/n: **91-013**
16" x 20" x 5" MERV 11 Filter p/n: **91-012**
20" x 25" x 1" MERV 11 Filter p/n: **91-021**
16" x 25" x 1" MERV 11 Filter p/n: **91-020**
20" x 20" x 1" MERV 11 Filter p/n: **91-022**
16" x 20" x 1" MERV 11 Filter p/n: **91-023**

20" x 25" x 1/2" PCO Filter p/n: **91-030**
16" x 25" x 1/2" PCO Filter p/n: **91-031**
20" x 20" x 1/2" PCO Filter p/n: **91-032**
16" x 20" x 1/2" PCO Filter p/n: **91-033**
Photo Catalytic UV-A Lamps p/n: **LP-PP-0052**
12" UV-C Lamps (if equipped) p/n: **AS-IH-1001**
17" UV-C Lamps (if equipped) p/n: **AS-IH-1003**

(See Serial Number Label on inside of equipment door for unit replacement part numbers)