

This Owner's Manual is provided and hosted by [Appliance Factory Parts](#).



# AMANA AMV4204AAQ Owner's Manual

[Shop genuine replacement parts for AMANA  
AMV4204AAQ](#)



[Find Your AMANA Microwave Parts - Select From 149 Models](#)

----- Manual continues below -----

# *Over The Range*

---

## Installation Instructions

### Contents

|  |    |
|--|----|
| Important Safety Information .....                                 | 2  |
| Parts, Tools, Materials .....                                      | 6  |
| STEP 1: Prepare The Electrical Connection .....                    | 8  |
| STEP 2: Prepare The Venting System .....                           | 9  |
| STEP 3: Prepare The Venting Blower .....                           | 11 |
| STEP 4: Prepare The Wall & Upper Cabinet<br>For Installation ..... | 13 |
| STEP 5: Install The Mounting Plate .....                           | 15 |
| STEP 6: Attach The Oven To The Wall .....                          | 17 |

### Electric Microwave

Keep instructions for future reference.

Be sure manual stays with microwave.

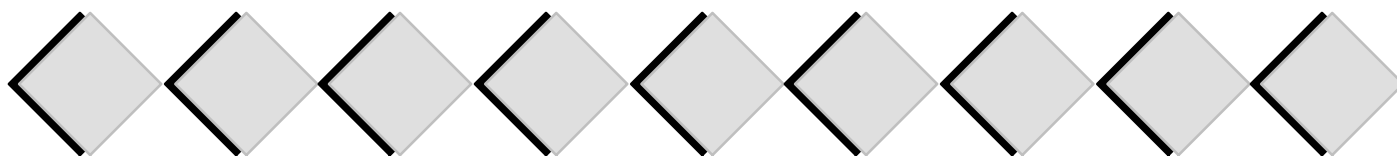

Part No.8101P641-60  
3828W5U0352  
(01-04-04)

# IMPORTANT SAFETY INFORMATION

## PRECAUTIONS TO AVOID POSSIBLE EXPOSURE TO EXCESSIVE MICROWAVE ENERGY

- A. DO NOT attempt to operate this oven with the door open since open-door operation can result in harmful exposure to microwave energy. It is important not to defeat or tamper with safety interlocks.
- B. DO NOT place any object between the oven front face and the door or allow soil or cleaner residue to accumulate on sealing surfaces.
- C. DO NOT operate oven if it is damaged. It is particularly important that oven door close properly and that there is no damage to the:
  - 1. Door (bent).
  - 2. Hinges and latches (broken or loosened).
  - 3. Door seals and sealing surfaces.
- D. Oven should NOT be adjusted or repaired by anyone except properly qualified service personnel.

### CAUTION

To avoid personal injury or property damage, observe the following:

1. Briskly stir or pour liquids before heating with microwave energy to prevent spontaneous boiling or eruption. Do not overheat. If air is not mixed into a liquid, liquid can erupt in oven or after removal from oven.
2. Do not deep fat fry in oven. Fat could overheat and be hazardous to handle.
3. Do not cook or reheat eggs in shell or with an unbroken yolk using microwave energy. Pressure may build up and erupt. Pierce yolk with fork or knife before cooking.
4. Pierce skin of potatoes, tomatoes, and similar foods before cooking with microwave energy. When skin is pierced, steam escapes evenly.
5. Do not operate equipment without load or food in oven cavity.
6. Use only popcorn in packages designed and labeled for microwave use. Popping time varies depending on oven wattage. Do not continue to heat after popping has stopped. Popcorn will scorch or burn. Do not leave oven unattended.
7. Do not use regular cooking thermometers in oven. Most cooking thermometers contain mercury and may cause an electrical arc, malfunction, or damage to oven.
8. Do not heat baby bottles in oven.
9. Do not use metal utensils in oven.
10. Never use paper, plastic, or other combustible materials that are not intended for cooking.
11. When cooking with paper, plastic, or other combustible materials, follow manufacturer's recommendations on product use.
12. Do not use paper towels which contain nylon or other synthetic fibers. Heated synthetics could melt and cause paper to ignite.
13. Do not heat sealed containers or plastic bags in oven. Food or liquid could expand quickly and cause container or bag to break. Pierce or open container or bag before heating.
14. To avoid pacemaker malfunction, consult physician or pacemaker manufacture about effects of microwave energy on pacemaker.

**SAVE THESE INSTRUCTIONS**

# IMPORTANT SAFETY INFORMATION

 **Recognize this symbol as a SAFETY message**

## **WARNING**

When using electrical equipment, basic safety precautions should be followed to reduce the risk of burns, electrical shock, fire, or injury to persons.

1. **READ** all instructions before using equipment.
2. **READ AND FOLLOW** the specific "PRECAUTIONS TO AVOID POSSIBLE EXPOSURE TO EXCESSIVE MICROWAVE ENERGY" on page 2.
3. This equipment **MUST BE GROUNDED**. Connect only to properly **GROUNDED** outlet. See "GROUNDING INSTRUCTIONS" on page 4.
4. Install or locate this equipment **ONLY** in accordance with the installation instructions in this manual.
5. Some products such as whole eggs and sealed containers - for example, closed glass jars - may explode and **SHOULD NOT** be **HEATED** in this oven.
6. Use this equipment **ONLY** for its intended use as described in this manual. Do not use corrosive chemicals or vapors in this equipment. This type of oven is specifically designed to heat or cook. It is not designed for industrial or laboratory use.
7. As with any equipment, **CLOSE SUPERVISION** is necessary when used by **CHILDREN**.
8. **DO NOT** operate this equipment if it has a damaged cord or plug, if it is not working properly, or if it has been damaged or dropped.
9. This equipment, including power cord, must be serviced **ONLY** by qualified service personnel. Special tools are required to service equipment.
10. **DO NOT** cover or block filter or other openings on equipment.
11. **DO NOT** store this equipment outdoors. **DO NOT** use this product near water - for example, near a kitchen sink, in a wet basement, or near a swimming pool, and the like.
12. **DO NOT** immerse cord or plug in water.
13. Keep cord **AWAY** from **HEATED** surfaces.
14. **DO NOT** let cord hang over edge of table or counter.
15. Do not use this oven for commercial purposes. It is made for household use only.
16. Clean the ventilating hood frequently.
17. Do not allow grease to accumulate on the hood or filters.
18. Use care when cleaning the ventilating hood filters. Corrosive cleaning agents such as lye-based oven cleaners may damage the filters.
19. When flaming foods under the hood, turn the fan on.
20. Suitable for use above both gas and electric cooking equipment 36 inches or less wide.

## **CAUTION**

To reduce the risk of fire in the oven cavity:

- a. **DO NOT** overcook food. Carefully attend equipment if paper, plastic, or other combustible materials are placed inside the oven to facilitate cooking.
- b. Remove wire twist-ties from paper or plastic bags before placing bag in oven.
- c. **KEEP** oven **DOOR CLOSED**, turn oven off, and disconnect the power cord, or shut off power at the fuse or circuit breaker panel, if materials inside the oven should ignite. Fire may spread if door is opened.
- d. **DO NOT** use the cavity for storage. **DO NOT** leave paper products, cooking utensils, or food in the cavity when not in use.

## SAVE THESE INSTRUCTIONS

# IMPORTANT SAFETY INFORMATION

## FEDERAL COMMUNICATIONS COMMISSION RADIO FREQUENCY INTERFERENCE STATEMENT ( U.S.A. ONLY)

This equipment generates and uses ISM frequency energy and if not installed and used properly, that is in strict accordance with the manufacturer's instructions, may cause interference to radio and television reception. It has been type tested and found to comply with limits for ISM Equipment pursuant to part 18 of FCC Rules, which are designed to provide reasonable protection against such interference in a residential installation. However, there is no guarantee that interference will not occur in a particular installation. If this equipment does cause interference to radio or television reception, which can be determined by turning the equipment off and on, the user is encouraged to try to correct the interference by one or more of the following:

- Reorient the receiving antenna of the radio or television.
- Relocate the Microwave Oven with respect to the receiver.
- Move the microwave oven away from the receiver.
- Plug the microwave oven into a different outlet so that the microwave oven and the receiver are on different branch circuits.

**The manufacturer** is not responsible for any radio or TV interference caused by **unauthorized** modification to this microwave oven. It is the responsibility of the user to correct such interference.

## SAVE THESE INSTRUCTIONS

### Grounding Instructions

**Oven MUST be grounded.**

Grounding reduces risk of electric shock by providing an

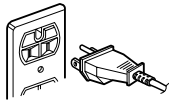

escape wire for the electric current if an electrical short occurs. This oven is equipped with a cord having a grounding wire with a grounding plug. The plug must be plugged into an outlet that is properly installed and grounded.

Consult a qualified electrician or servicer if grounding instructions are not completely understood, or if doubt exists as to whether the oven is properly grounded.

**Do not use an extension cord.** If the product power cord is too short, have a qualified electrician install a three-slot receptacle. This oven should be plugged into a separate 60 hertz circuit with the electrical rating as shown in specifications table. When the combination oven is on a circuit with other equipment, an increase in cooking times may be required and fuses can be blown.

Microwave operates on standard household current, 110-120V.

# IMPORTANT SAFETY INFORMATION

## WARNING

To avoid risk of personal injury, install microwave oven only as instructed.

## WARNING

To avoid risk of personal injury, place a piece of the carton or other heavy material, such as a blanket, over the countertop or cooktop to protect it. **DO NOT** use a plastic cover.

**NOTE:** 33" from the countertop to the top of microwave cut out is recommended for optimal performance of range and microwave.

## Make Sure You Have Enough Space And Support

- Mount the oven against a flat, vertical wall, so it is supported by the wall. The wall should be constructed of minimum 2" x 4" wood studding and 3/8" thick drywall or plaster/lath.
- **ATTACH AT LEAST ONE** of the two lag screws supporting the oven to a vertical, 2" x 4" wall stud.
- **DO NOT** mount the microwave oven to an island or peninsula cabinet.
- **BE SURE** the upper cabinet and rear wall structures are able to support 150 lbs., plus the weight of any items you place inside the oven or upper cabinet.
- Locate the oven away from strong draft areas, such as windows, doors, and strong heating vents.
- **BE SURE** you have enough space. See Figure 3 below for minimum vertical and horizontal clearance.
- This microwave oven can be installed over gas or electric cooking products no more than 36 inches wide.

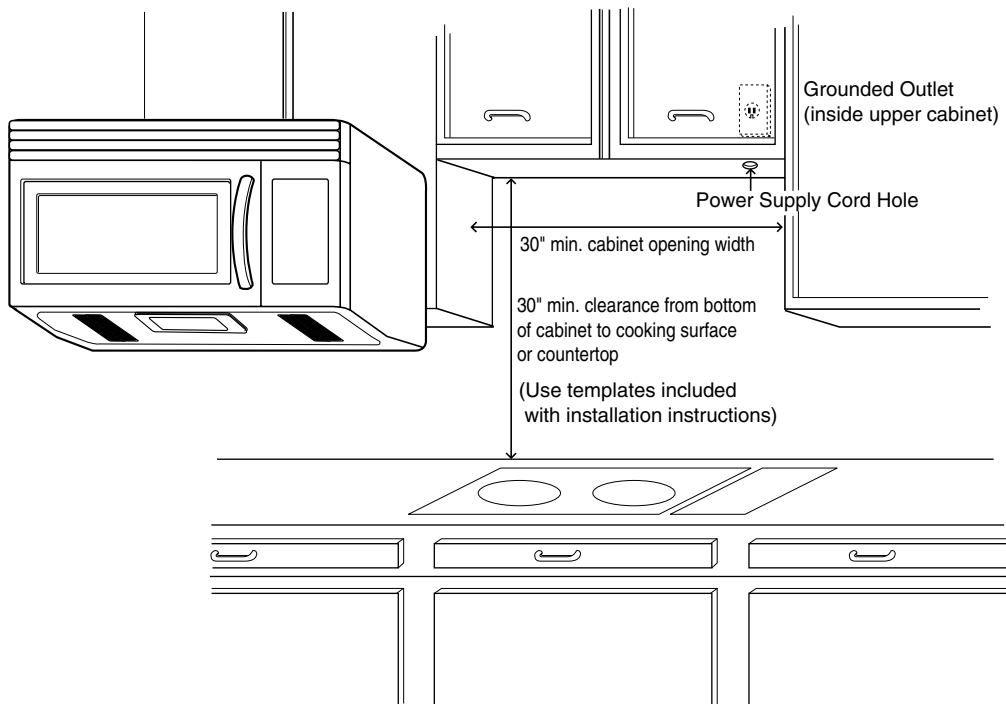

Figure 3

# Parts, Tools, Materials

## THE FOLLOWING PARTS ARE SUPPLIED WITH THE OVEN:

NOTE: Depending on your ventilation requirements, you may not use all of these parts.

### Damper/duct connector

(for roof venting or wall venting installation)  
Not Actual Size (2 pieces must be assembled as shown)

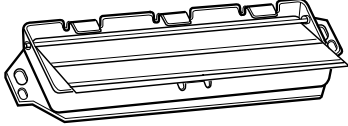

**One power cord clamp and  
One dark-colored mounting screw**  
(to hold the power cord)  
Actual Size

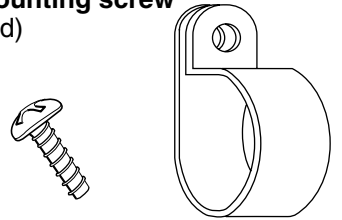

**One power cord clamp bushing** - Actual Size (for the cord hole in a metal upper cabinet)

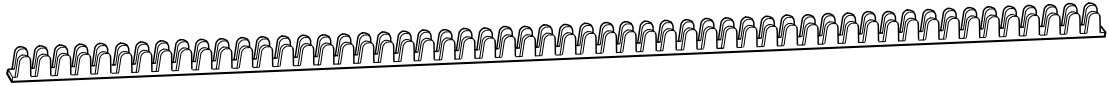

**Four 1/4" x 2" lag screws** - Actual Size  
(for wall stud holes)

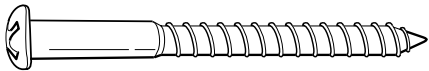

**Four 1/4" x 3" toggle bolts** - Actual Size  
(for drywall holes)

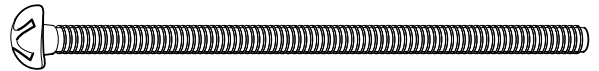

**Two 1/4" x 3" bolts** - Actual Size  
(for securing to the upper cabinet)

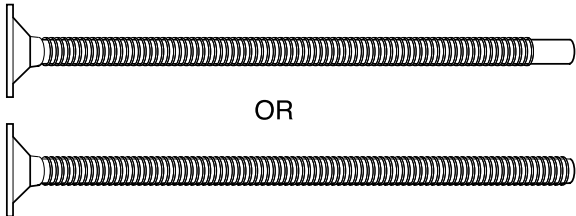

OR

**Two tapping screws** - Actual Size  
(for attaching the damper duct connector)

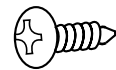

**One upper cabinet template**- Not Actual Size

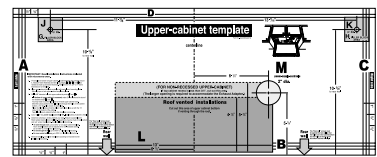

**Four spring toggle heads** - Actual Size  
(for the toggle bolts)

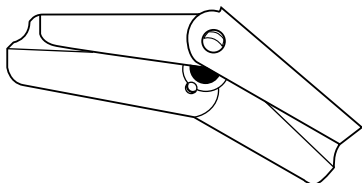

**One rear wall template**- Not Actual Size

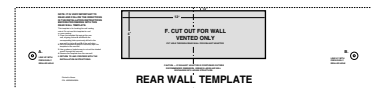

NOTE: You need to install at least two lag screws into a 2" x 4" stud and four anchor bolts into the wall. and the mounting area must meet the 150 lbs. weight requirement.

# Parts, Tools, Materials

You will need the following tools and materials for the installation:

Carton or other heavy material for covering the counter top.

Clear Tape  
(for taping the templates to the wall)



Stud Finder or Thin Nail

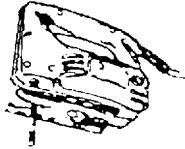

Saber Saw  
(for cutting vent holes for roof  
or wall vending)

Keyhole Saw (for the power cord hole)

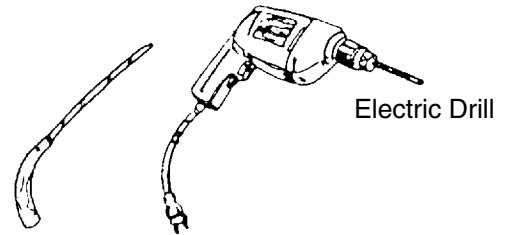

Electric Drill

3/8" and 3/4" wood drill bits



1/2" and 3/16"  
drill bits

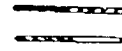

Phillips Screwdriver  
(for the screws)



Pencil



Flat Blade Screwdriver  
(for the toggle bolts)

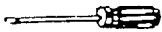

Plumb Line

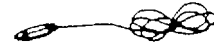

Measuring Tape  
(metal preferred)

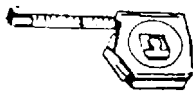

Duct Tape

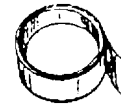

Small Side Cutters or Tin Snips



Caulking Gun

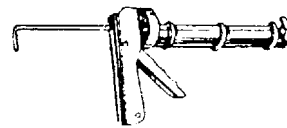

- If you have brick or masonry walls, you will need special hardware and tools.
- The ductwork you need for the installation is not included. All wall and roof caps must have a back-draft damper. (Shown on page 6).

# STEP 1: *Prepare The Electrical Connection*

## ⚠ W A R N I N G ⚠

**AVOID ELECTRICAL SHOCK! THIS APPLIANCE MUST BE GROUNDED!**

1. Locate the grounded electric outlet for this oven in the cabinet above the oven, as shown in Figure 4.

**NOTE:** The outlet should be on a circuit dedicated to the microwave oven (120V, 60 Hz., AC only) with a 15 or 20A fused electrical supply.

**IMPORTANT:** If you do not have the proper wall outlet, you **MUST** have one installed by a qualified electrician.

2. You will cut the power-supply-cord hole (shown in Figure 4) later when you prepare the wall and upper cabinet in Step 4.

**NOTE:** Do not use an extension cord.  
Keep the power cord dry and do not pinch or crush it.

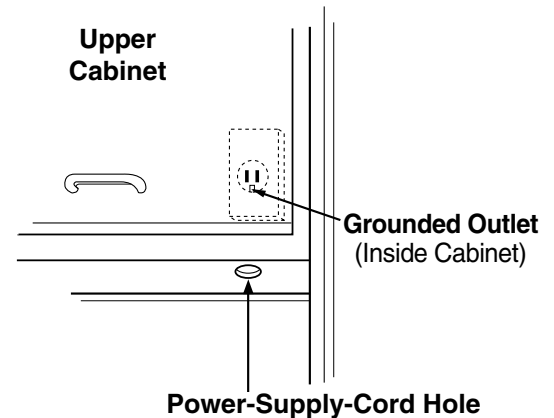

Figure 4

## ⚠ W A R N I N G ⚠

**Improper grounding could result in electric shock or other personal injury.**

- DO NOT, UNDER ANY CIRCUMSTANCES, REMOVE THE POWER SUPPLY CORD GROUNDING PRONG!
- This appliance **MUST** be grounded!

# STEP 2: *Prepare The Venting System*

**NOTE:** The ductwork you need for outside ventilation is not included with your oven. The standard ductwork fittings and length are shown in Figure 9, page 10.

**! WARNING - FIRE HAZARD !**

**THIS OVEN MUST BE PROPERLY VENTED!**

You may vent your oven in one of three ways. However, do NOT vent into a wall cavity, an attic, or an unused area.

- **Roof-venting** If your oven is located on an outside wall near the roof, as in Figures 6 (3 1/4" x 10" duct) and Figure 8 (6" round duct.)
- **Wall-venting** If your oven is located on an outside wall of your house, as in Figure 5 (3 1/4" x 10" duct) and Figure 8 (6" round duct.)
- **Room-venting** If your oven is located on an inside wall of your house, as in Figure 7.

**NOTE:** If you choose the rear exhaust method (roof-or wall-venting), be sure there is enough clearance within the wall for the exhaust duct.

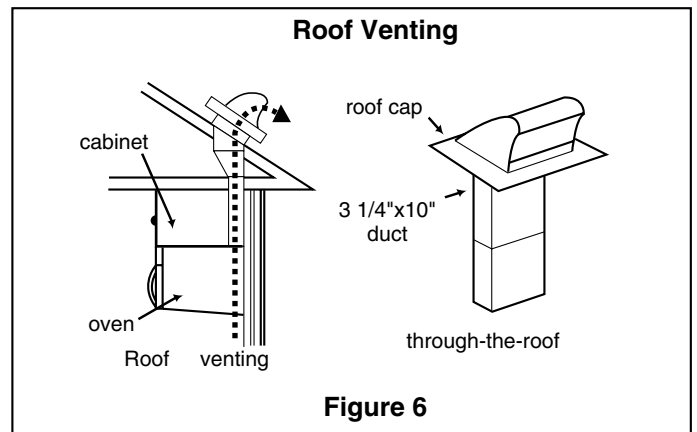
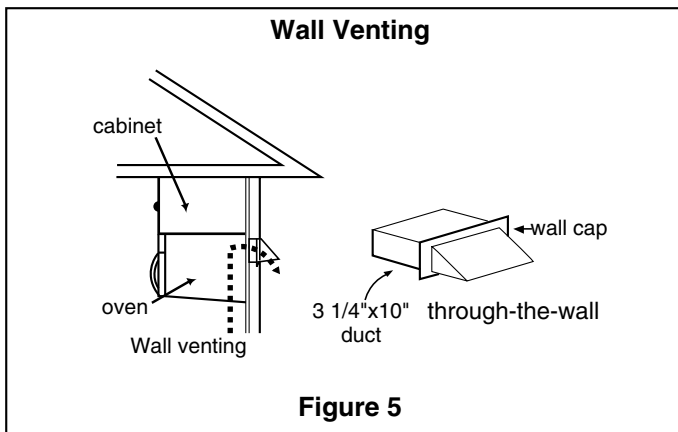

## REMEMBER AS YOU INSTALL THE VENTING:

- Keep the length of the ductwork and the number of elbows to a minimum to ventilate your oven efficiently. See examples on page 10.
- Keep the size of the ductwork the same.
- Do not install two elbows together.
- Use duct tape to seal all joints in the duct system.
- Use caulking to seal the exterior wall or roof opening around the cap.

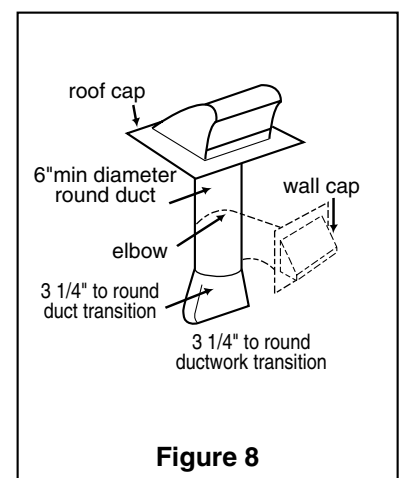
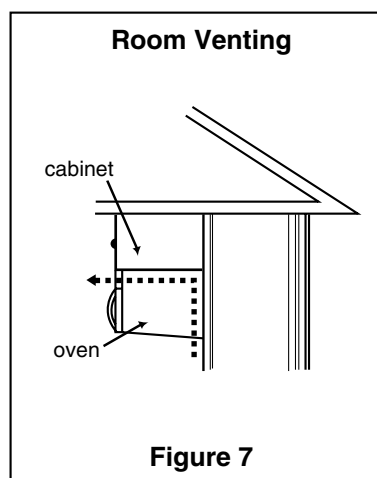

# STEP 2: Prepare The Venting System

## Standard Fittings

**NOTE:** If the existing duct is round, you must use a rectangular-to-round adapter, with a rectangular 3" extension duct installed between the damper assembly and the adapter to prevent the exhaust damper's sticking.

## Duct Length

The total length of the duct system, including straight duct, elbows, transitions, and wall or roof caps **must not exceed the equivalent of 140 feet.**

For best performance, do not use more than three 90 degree elbows, and keep length as short as possible.

Below are the standard fittings and their equivalent length in feet.







|   |  |   |  |   |  |
|---|--|---|--|---|--|
| 1 |   | 2 |   | 3 |   |
|   | 3 1/4" x 10"<br>to 6"=5ft.   |   | 3 1/4" x 10" roof<br>cap=24ft.   |   | 3 1/4" x 10" 90°<br>elbow=25ft.  |
| 4 |  | 5 |  | 6 |    |
|   | 90° elbow<br>=10ft.  |   | 3 1/4" x 10"<br>wall cap<br>=40ft.   |   | 45° elbow<br>=5ft.   |
|   |  |   |  | 7 |  |
|   |  |   |  |   | 3 1/4" x 10"<br>flat elbow<br>=10ft.   |

Figure 9

To calculate the equivalent length of each duct piece used, see the examples below.

| Examples  |  |
|---|--|
| <p><b>For 3 1/4"x10" SYSTEMS</b></p>                     | <p><b>For 6" ROUND SYSTEMS</b></p>                                 |
| <p>1-3 1/4" x 10" 90° elbow = 25 ft.</p> <p>1-Wall Cap = 40 ft.</p> <p>8 feet straight duct = 8 ft.</p> <p><b>TOTAL LENGTH = 73 ft.</b></p> | <p>1-transition = 5 ft.</p> <p>2-90° elbows = 20 ft.</p> <p>1-Wall Cap = 40 ft.</p> <p>8 feet straight = 8 ft.</p> <p><b>TOTAL LENGTH = 73 ft.</b></p> |

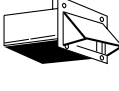
# STEP 3: Prepare The Venting Blower

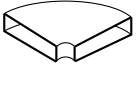
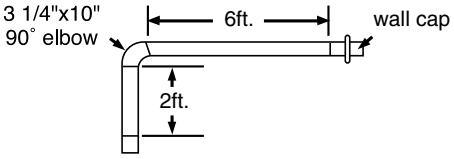
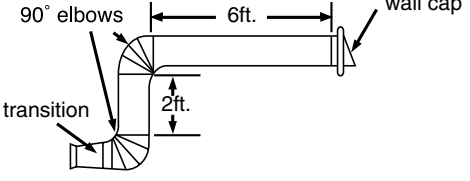
## ⚠ WARNING ⚠

To avoid risk of property damage, unplug the microwave oven or disconnect power at source by removing fuse or throwing circuit breaker.

To avoid risk of personal injury, wear protective gloves when handling mounting plate.

**DO NOT PULL OR STRETCH THE BLOWER WIRING!** Pulling and stretching the blower wiring could result in electrical shock.

Your microwave oven is shipped with the blower assembled for room venting. If you want wall-venting or roof-vented installation, you must change the blower, as detailed below.

### Before You Start

1. Remove any shipping materials and parts from inside the microwave oven.
2. Cover the counter top or cooktop with a thick, protective covering to protect it from damage and dirt. See Figure 10.

**NOTE:** If you have a free-standing range, disconnect it, move it onto a piece of cardboard or hardboard and pull it away from the wall, so that you can get closer to the upper cabinet and back wall for easier measuring and drilling.

### Remove The Mounting Plate:

1. Remove mounting plate screw(s) (1 or 2 screws) from the mounting plate as shown and discard. See Figure 11.
2. This plate will be used as the rear mounting plate. (It will be used to locate and mark the mounting holes on the rear wall.)
3. Locate exhaust adaptor, grease filters and hardware packet.
4. At this point, remove any adhesive tape (if there is any), on the exhaust adaptor, the grease filters and the power supply cord.

### Room-Vented (recirculating) Installation:

This oven is shipped assembled for room-vented.

### Wall-Vented Installation:

1. Remove one blower unit mounting screw and one or two blower plate screw(s). Remove the blower plate from cabinet. See Figure 12.
2. Carefully lift the blower unit out of the microwave oven.
3. Use side cutters or thin snips to cut and remove knockouts "B" from Back plate. Discard knockouts. Be careful not to distort the plate. See Figure 13.

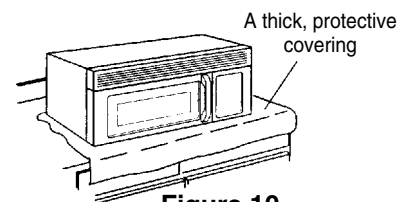

Figure 10

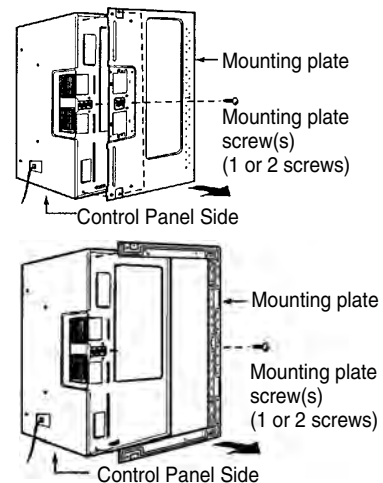

Figure 11

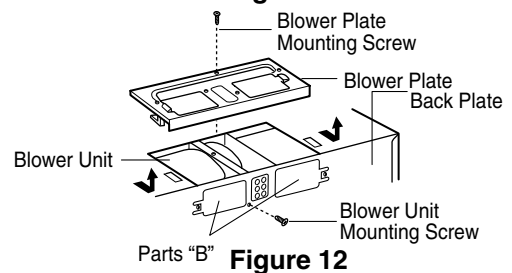

Figure 12

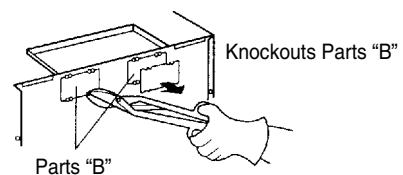

Figure 13

# STEP 3: Prepare The Venting Blower

4. Reassemble the blower wire. See Figure 14.
5. Rotate the unit so that the exhaust ports face the rear of the cabinet. See Figure 16. When you insert blower unit, blower wire must be like figure 15.
6. Place blower unit back into cabinet. Check that the exhaust ports face towards the rear of the cabinet. See Figure 16.
7. Reattach the blower plate to cabinet so the exhaust ports and blower plate opening are aligned. Attach with one blower unit mounting screw and then one blower plate mounting screw. See Figure 17.

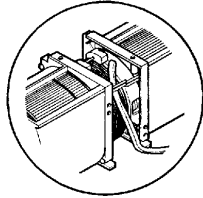

Figure 14

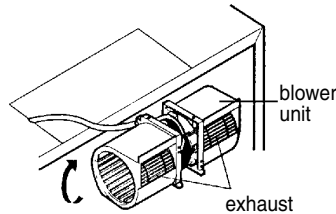

Figure 15

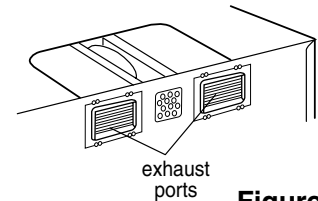

Figure 16

## Roof-Vented Installation:

1. Remove one blower unit mounting screw and one or two blower plate screw(s). Remove the blower plate from cabinet. See Figure 18.
2. Use side cutter or thin snips to cut and remove knockouts "A" from Blower plate. Discard knockouts. Be careful not to distort the plate. See Figure 19.
3. Carefully lift the blower unit out of the microwave oven.
4. Rotate blower unit 90° so the exhaust ports face the upper of the cabinet. See Figure 20.
5. Reassemble the blower wire.
6. Place blower unit back into microwave oven.
7. Reattach blower plate to microwave oven. Attach with the one blower unit mounting screw and then the one or two blower plate mounting screw(s). See Figure 21.
8. Attach the exhaust adaptor to the blower plate by sliding it into the Guide. See Figure 22.

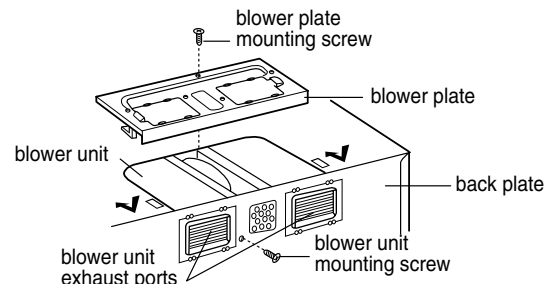

Figure 17

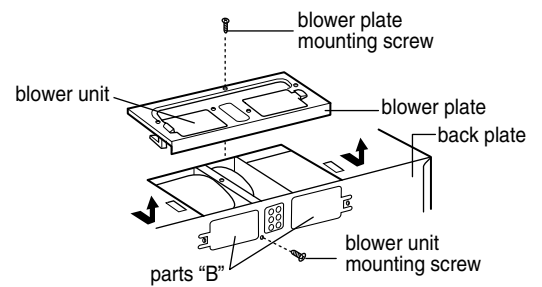

Figure 18

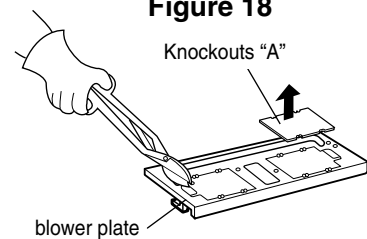

Figure 19

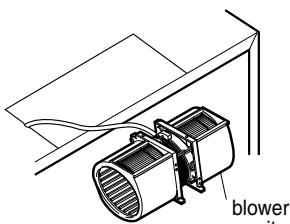

Figure 20

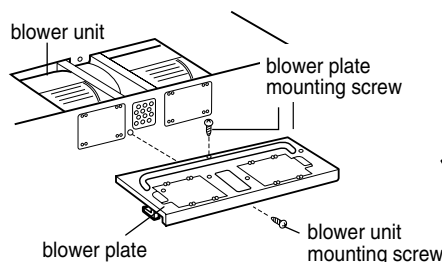

Figure 21

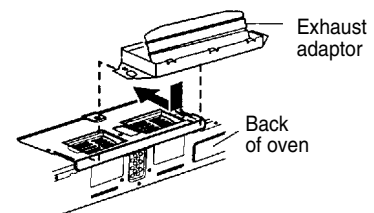

Figure 22

# STEP 4: Prepare The Wall & Upper Cabinet

## ! WARNING !

To avoid personal injury or property damage, do not attempt to install this microwave oven if you cannot find a wall stud.

### Measure And Track/Tape Up The Templates

1. Using a plumb line and (metal) measuring tape, find and mark the vertical center line on the back wall, as in Figure 23.
2. Find and mark one or two points where the studs are on the wall. (Studs are normally 16 inches apart). Then measure and mark the stud locations. If you cannot find any wall stud, consult a local building contractor.

### CAUTION

DO NOT ATTEMPT TO INSTALL THE MICROWAVE OVEN IF YOU CANNOT FIND A WALL STUD.

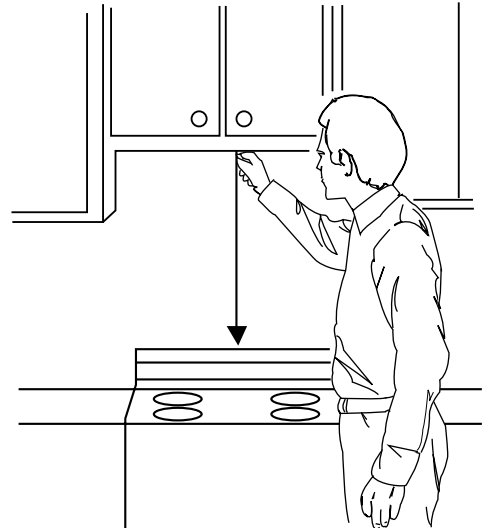

Figure 23

3. Line up the plumb line on the wall with the center line on the mounting plate.

NOTE: Be sure the minimum width is 30 inches and the distance from the top of the wall template to the range or counter top is at least 30 inches. See Figure 23.

4. Center mounting plate in operating by lining up the plumb line on wall with centerline on mounting plate. Make sure the minimum width is 30 inches and that the top of the mounting plate is located a minimum of 30 inches above the cooking surface. See Figure 24.

NOTE: If the cabinets are not plumb, adjust the mounting plate to the cabinets. If the front edge of the cabinet is lower than the back edge, adjust the mounting plate to be level with the cabinet front.

5. Measure the bottom of the upper cabinet frame. Trim the edges A, B and C on the upper cabinet template so that the template will fit on the bottom of the upper cabinet. If upper cabinet has a recessed frame, trim the template so it fits inside the recessed area. Align the centerline of the upper cabinet template with the centerline of the mounting plate, then securely tape or tack the upper cabinet template in place. See Figure 24.

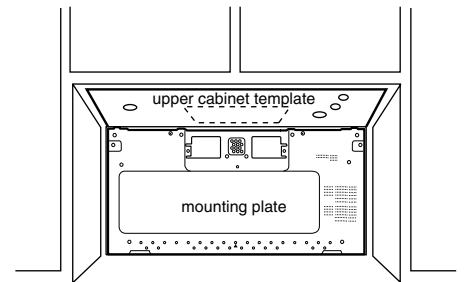

(1 piece mounting plate)

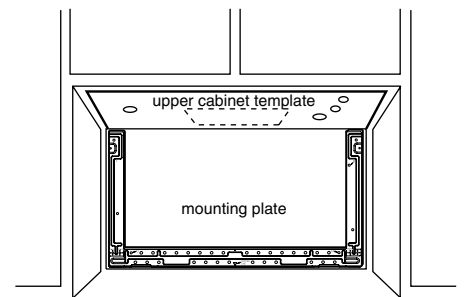

(3 pieces mounting plate)

Figure 24

# STEP 4: Prepare The Wall & Upper Cabinet

## ! W A R N I N G !

To avoid risk of personal injury, electrical shock or death:

- Note where electrical outlets and electrical wires are before you drill into the wall.
- Locate and disconnect power to any electrical circuits that could be affected by installing this oven.

## ! W A R N I N G !

To avoid risk of personal injury, electrical shock or death, cover the edge of the power supply cord hole with the power supply cord bushing.

### Drill The Holes In The Wall And Upper Cabinet.

1. Drill holes on the circles. If there is a stud, drill a 3/16" hole for lag screws. If there is no stud, drill a 3/4" hole for toggle screws. Make sure to use at least 1 lag screw in a stud, and 4 toggle screws in the drywall or the plaster.
2. Drill a 3/8" hole at points J and K on the upper cabinet template.

**NOTE:** If the bottom of the upper cabinet is recessed 3/4" or more, you will need 2"x 2" filler blocks (not included) to provide additional support for the bolts. See Figure 25.

- Mark the center of each filler block and drill a 3/8" diameter hole at the marks.
- Align filler blocks over the two openings in the top of the microwave oven cabinet and attach to cabinet with masking tape. See Figure 26.

3. Cut or drill a 2" diameter hole at the area marked M. Power supply cord hole on the upper cabinet template. If the upper cabinet is metal, you will need to cover the edge of the hole with the power supply cord bushing (supplied) to prevent damage to the cord from the rough metal edge.
4. Cut out the venting areas (with the saber saw):
  - Roof-Vented: cut out the shaded area marked L on the upper cabinet template.
  - Wall-Vented: Tape the rear wall template to the rear wall, lining up with the holes previously drilled for holes A and B in the plate. Cut out the shaded area marked F on the REAR WALL TEMPLATE.
  - Room-Vented: go to STEP 5, INSTALL THE MOUNTING PLATE, located on page 15.
5. Complete whichever venting system you have chosen. Use caulking compound to seal the exterior wall or roof opening around the wall cap or roof cap.

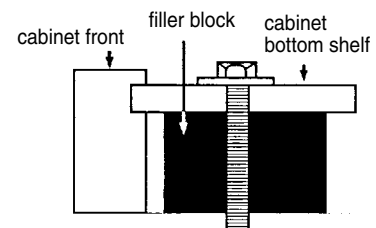

Figure 25

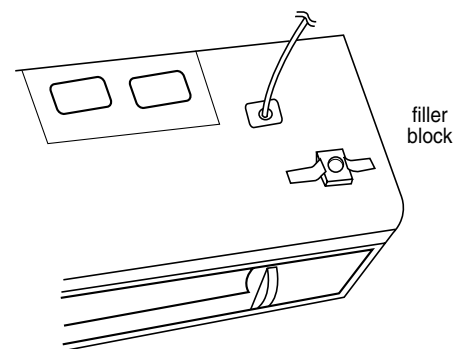

Figure 26

# STEP 5: *Install The Mounting Plate*

## The Oven Must Be Connected To At Least One

### Wall Stud.

1. Draw a vertical line on the wall at the center of the 30 wide space. Use the mounting plate as the template for the rear wall. Place the mounting plate on the wall, making sure that the tabs are against the bottom of the cabinet. Line up the notch and center line on the mounting plate to the center line on the wall.
2. While holding the mounting plate with one hand, draw circles on the wall at holes A, B, C and D. Four holes must be used for mounting. If the holes are not used, the installation will not be secure. Installer must use these holes for proper installation. Use toggle bolts through these holes unless one of them lines up with a stud. Use a wood screw for studs.

**NOTE:** Draw a fifth circle inside area E, through one of the bottom holes to match the location of a stud. For wall-vented: The oven requires a rear wall cutout opening for the rear wall duct and the exhaust adaptor must be attached to the mounting plate. See the next page on how to prepare the rear wall cutout opening and the exhaust adaptor/mounting plate for wall-vented.

3. Drill holes on the circles. If there is a stud, drill a 3/16 hole for lag screws. If there is no stud, drill a 5/8 hole for toggle bolts. Make sure to use at least 1 lag screw in a stud, and 4 toggle bolts in the drywall or the plaster.
4. Attach the plate to the wall. To use spring toggle head bolts: Remove the toggle wings from the bolts. Insert the bolts into the mounting plate and replace the spring toggle head to 3/4 past the bolt ends. Insert the spring toggle head into the holes in the wall to mount the plate. You may pull forward on the plate to help in tightening the toggle bolts. Tighten all bolts.

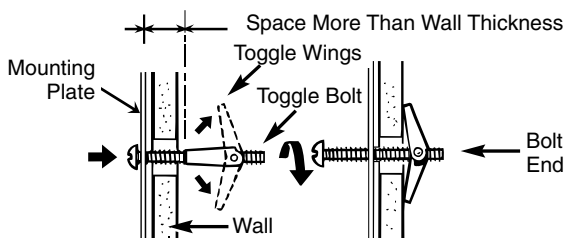

Figure 28

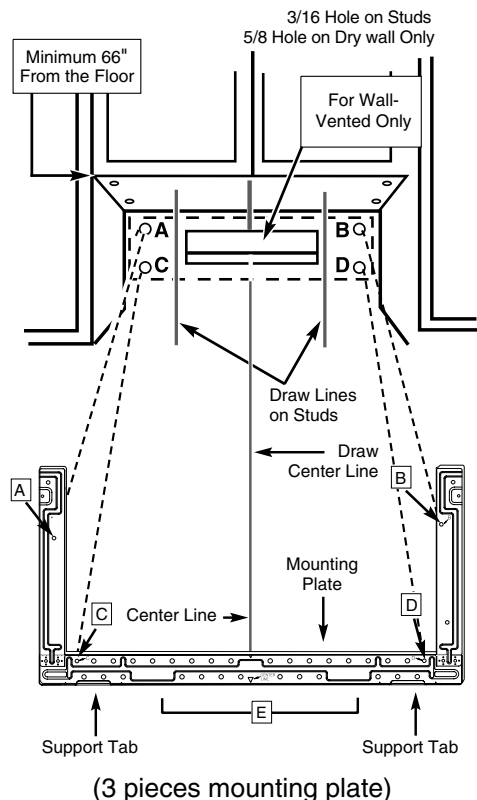
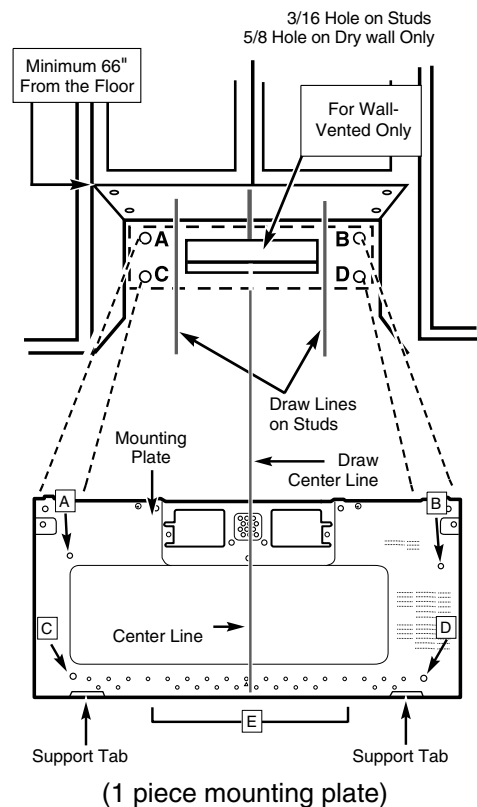

Figure 27

# STEP 5: *Install The Mounting Plate*

## For Wall-Vented

- Make the box cutout for the rear wall duct.
  - 1 piece mounting plate:  
Using a pencil, put dots through slots F and G, and through holes H and I. Remove the mounting plate and draw lines extending through the points. This will give the location and size of the box cutout for the rear wall duct. (Figure 29)
  - 3 pieces mounting plate:  
Use the wall template to determine the location and size of the box cutout for the rear wall duct.
- Attach the exhaust adaptor to the rear mounting plate (back plate) wall side. Push in securely until it is past the top locking tabs and in the lower locking tabs. Take care to assure the damper hinge is installed so that it is at the top and that the damper swings freely.
- Carefully guide the exhaust adaptor, now attached to the mounting plate, into the house duct. Before using the screws to attach the plate to the wall. This will assure proper alignment for installation.
- Return to step 5, item 3 to continue. After completing the installation of the mounting plate, again check the rear damper for free movement to assure it will operate properly.

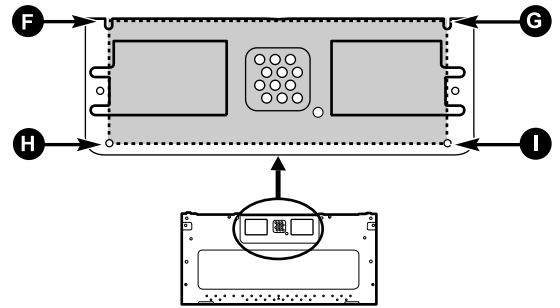

Figure 29

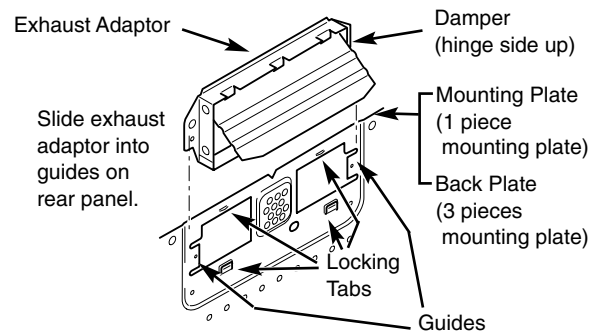

Figure 30

# STEP 6: *Attach The Oven To The Wall*

## ⚠ WARNING ⚠

To avoid risk of personal injury or property damage, you will need two people to install this microwave oven.

1. Carefully lift microwave oven and hang it on support tabs (See Figure 27) at the bottom of the mounting plate. Reaching through upper cabinet, thread power supply cord through the power supply cord hole in the bottom of the upper cabinet. See Figure 31.
2. Rotate the microwave oven upward so the top of oven is against the bottom of the upper cabinet or cabinet frame.
3. Then insert a bolt down through each hole in the upper cabinet bottom. See Figure 32. Tighten the bolts until the gap between the upper cabinet and microwave oven is closed.
4. If wall vented or room vented installation is used, go to No. 7 on the next page.

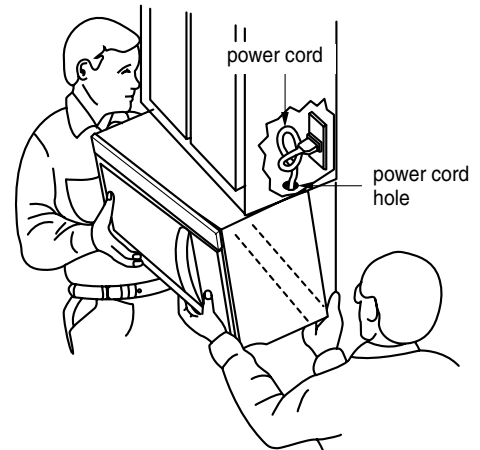

Figure 31

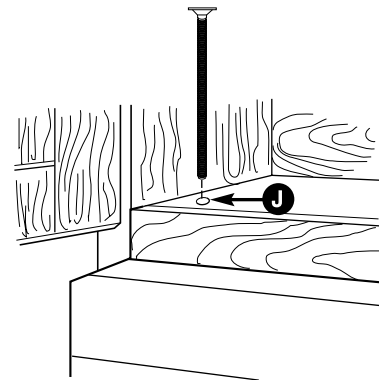

Figure 32

# STEP 6: Attach The Oven To The Wall

5. Roof venting installation: See Figure 33.  
Install ductwork through the vent opening in the upper cabinet. Complete the venting system through the roof according to the method needed. See "Prepare The Venting System" STEP 2.  
Use caulking gun to seal the exterior roof opening around the exhaust cap. See Figure 6 on page 9.

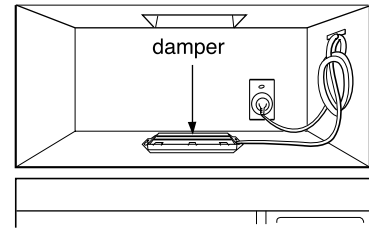

Figure 33

6. Use the power supply cord clamp to bundle the power supply cord. Install the power supply cord clamp, using a screw as shown in Figure 34, to inside of the cabinet.

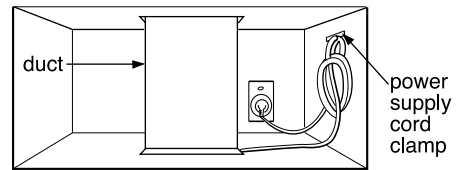

Figure 34

7. Grasp filter screen with one hand holding the ring and the other hand holding the opposite end. Insert the end of the filter screen without ring into the opening and slide towards the side of the microwave oven. Insert ring end of filter screen into the opening and slide entire screen towards the center of the microwave until screen is securely in position. Repeat for other filter screen. See Figure 35.

8. Plug in the power supply cord.

9. Read your Owner's Manual, then check the operation of your microwave oven.

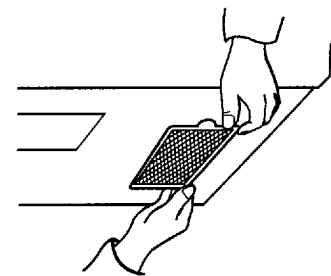
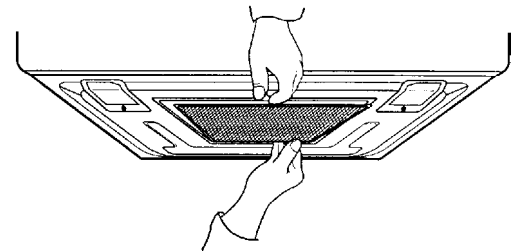

Figure 35