

This Owner's Manual is provided and hosted by [Appliance Factory Parts](#).

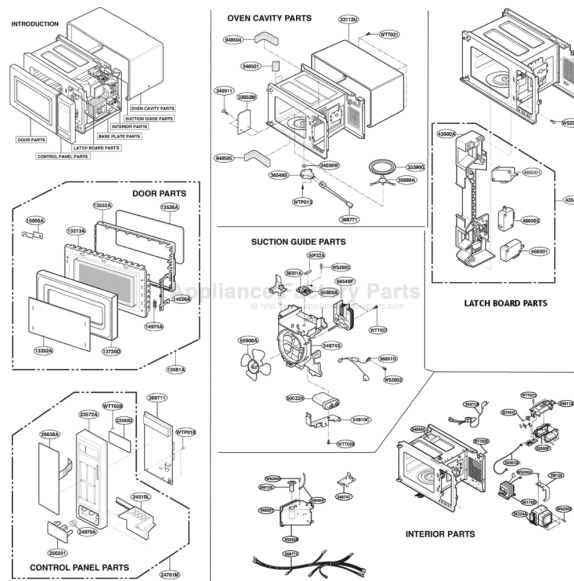

WHIRLPOOL KCMS135GBL Owner's Manual

[Shop genuine replacement parts for WHIRLPOOL
KCMS135GBL](#)



[Find Your WHIRLPOOL Microwave Parts - Select From 1350 Models](#)

----- Manual continues below -----

EXPLODED VIEW

INTRODUCTION

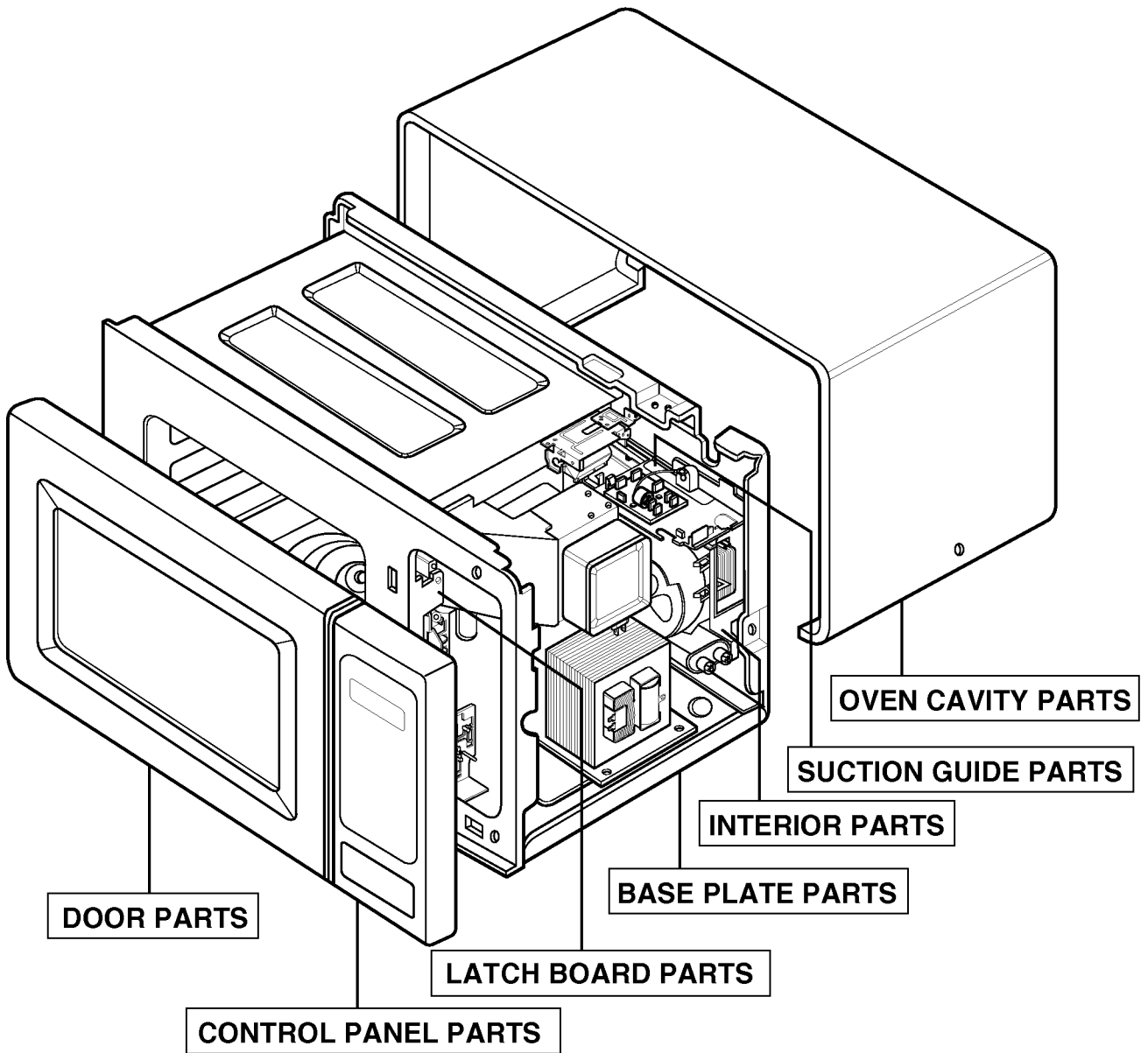

DOOR PARTS

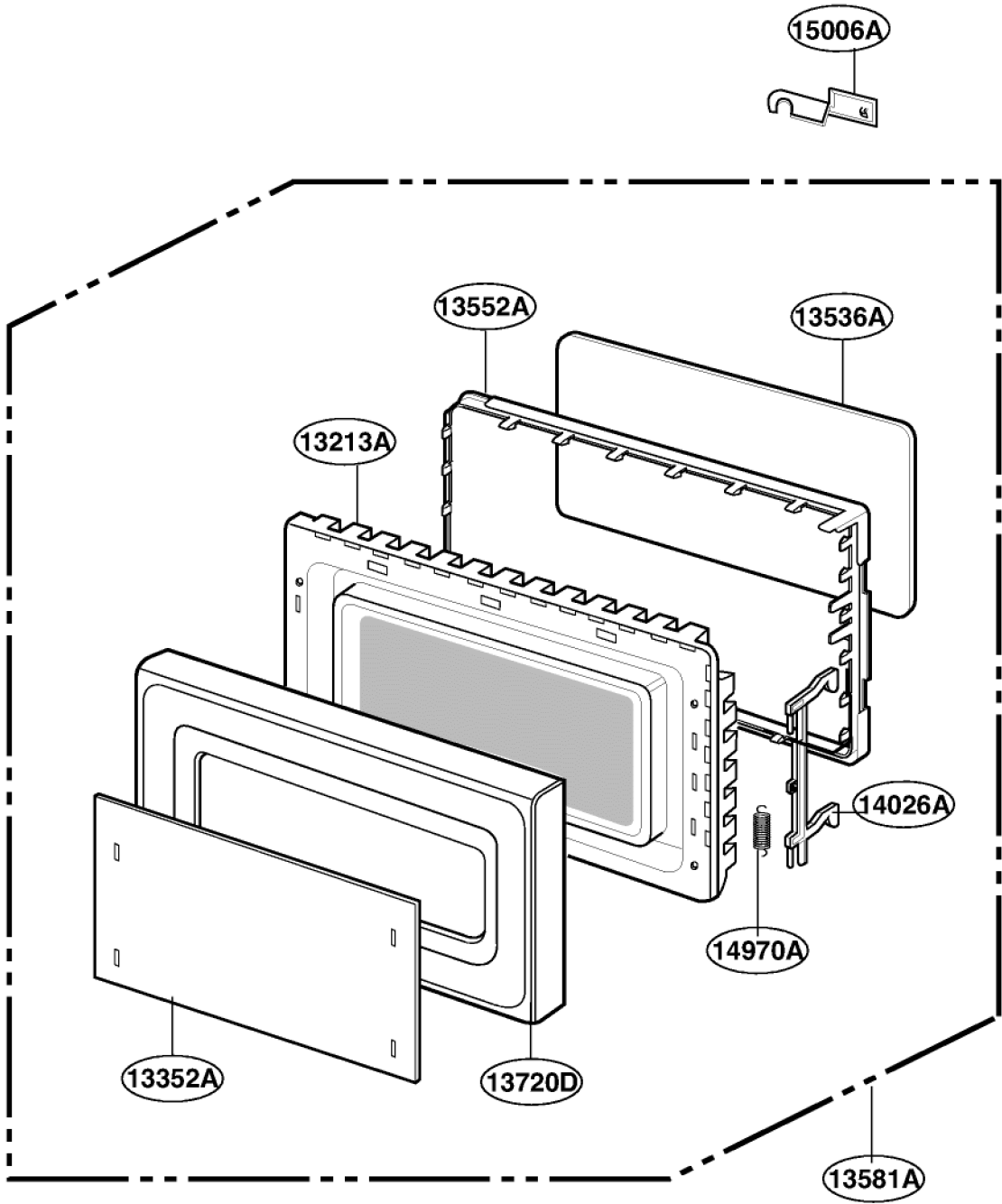

CONTROL PANEL PARTS

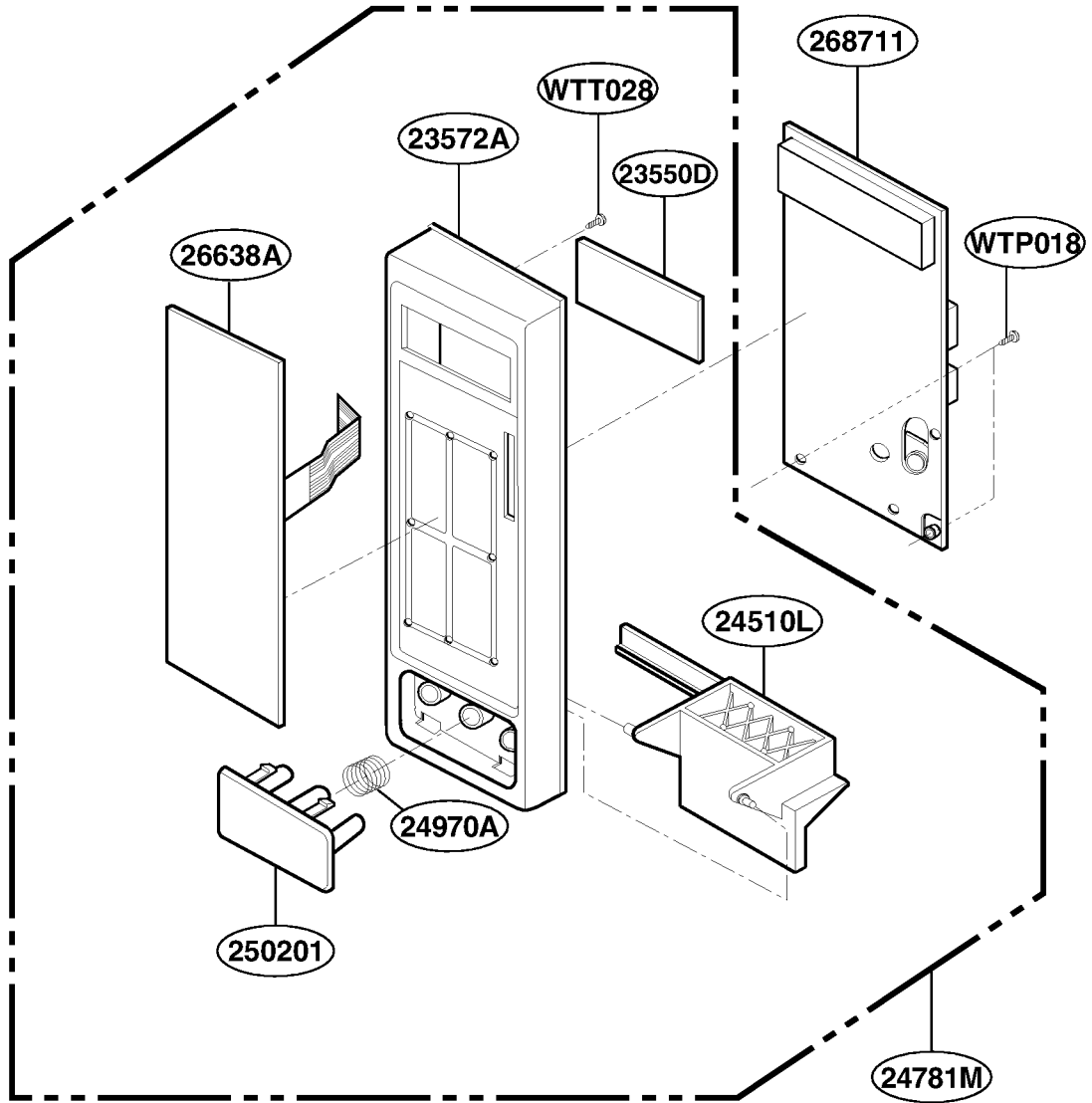

OVEN CAVITY PARTS

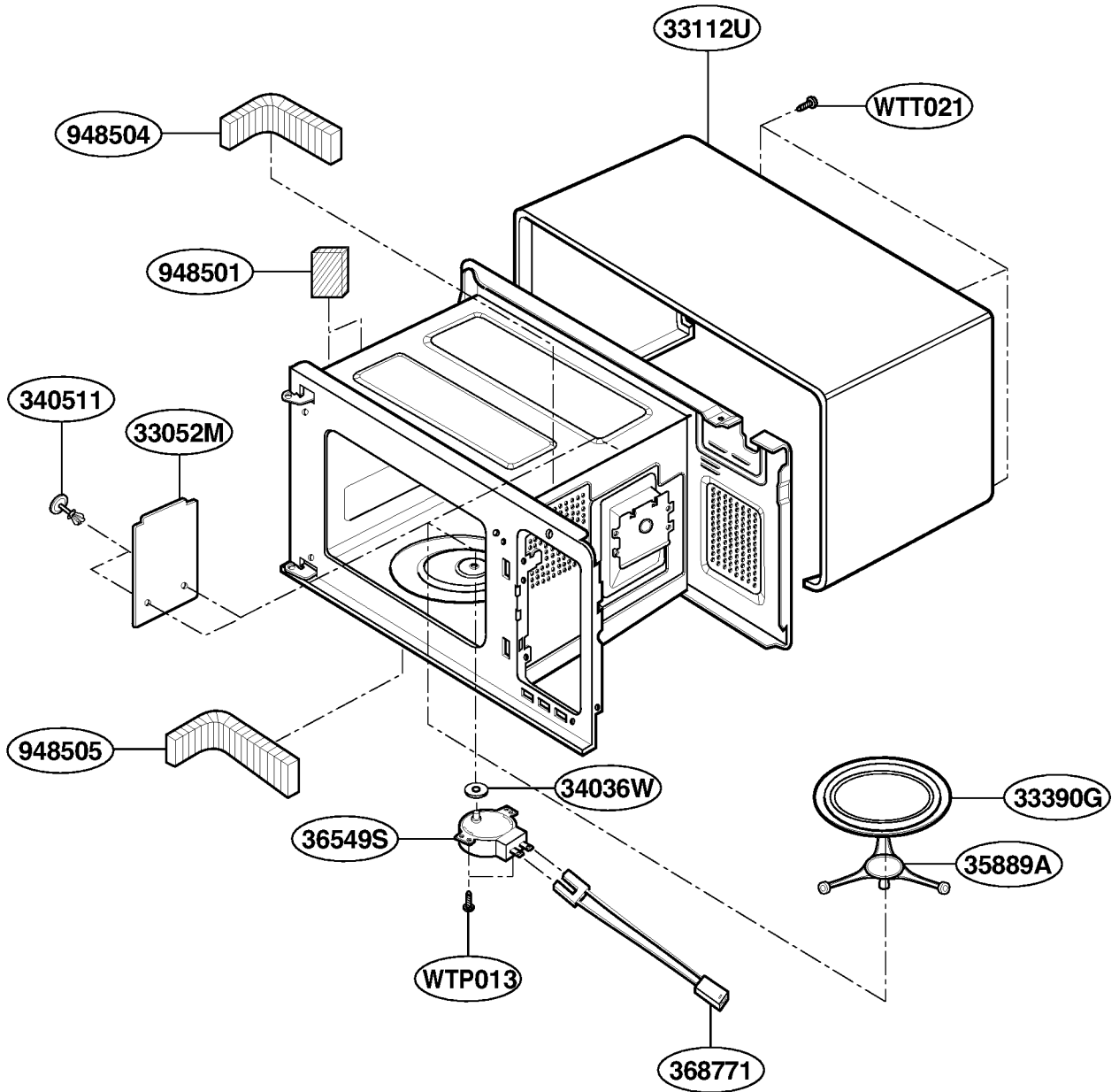

LARCH BOARD PARTS

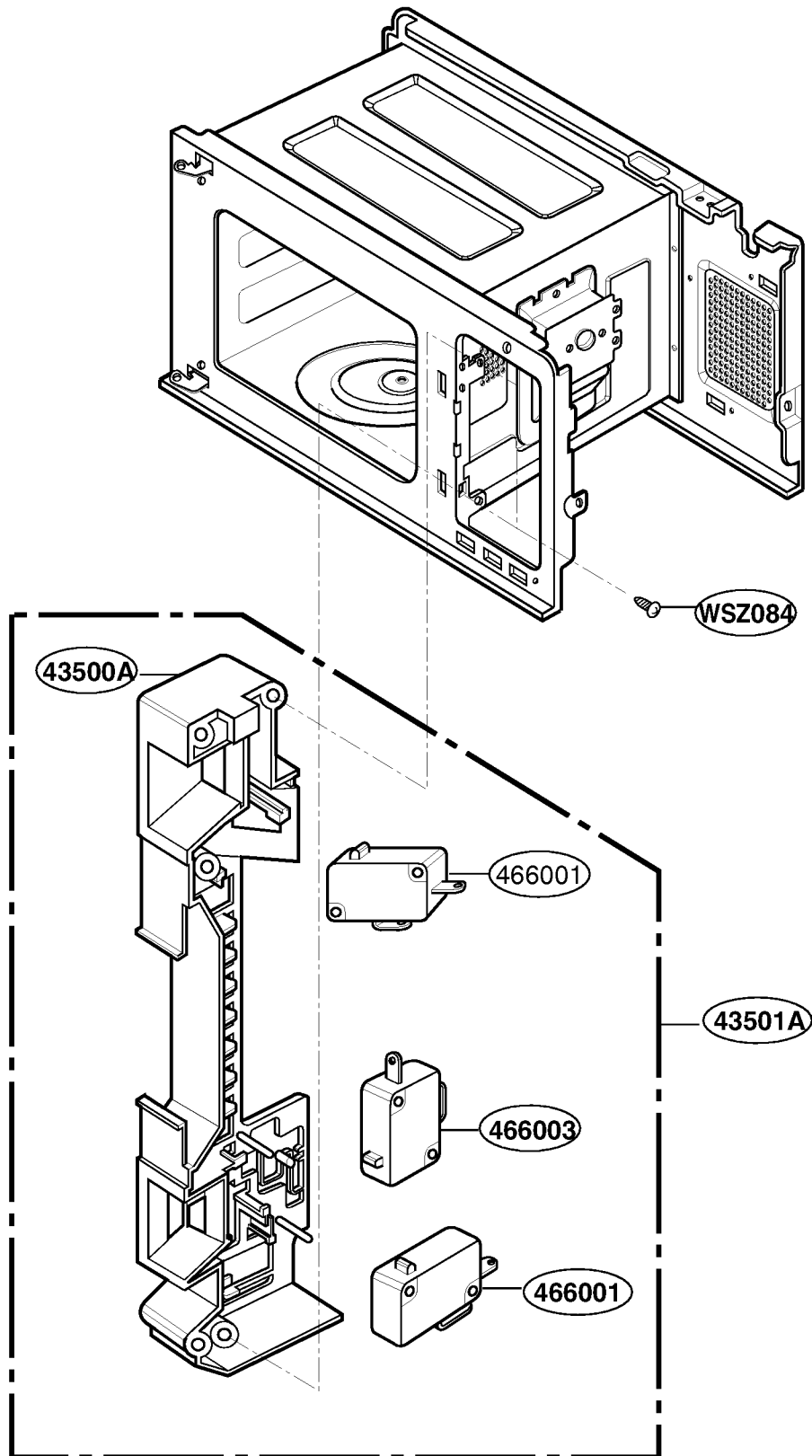

SUCTION GUIDE PARTS

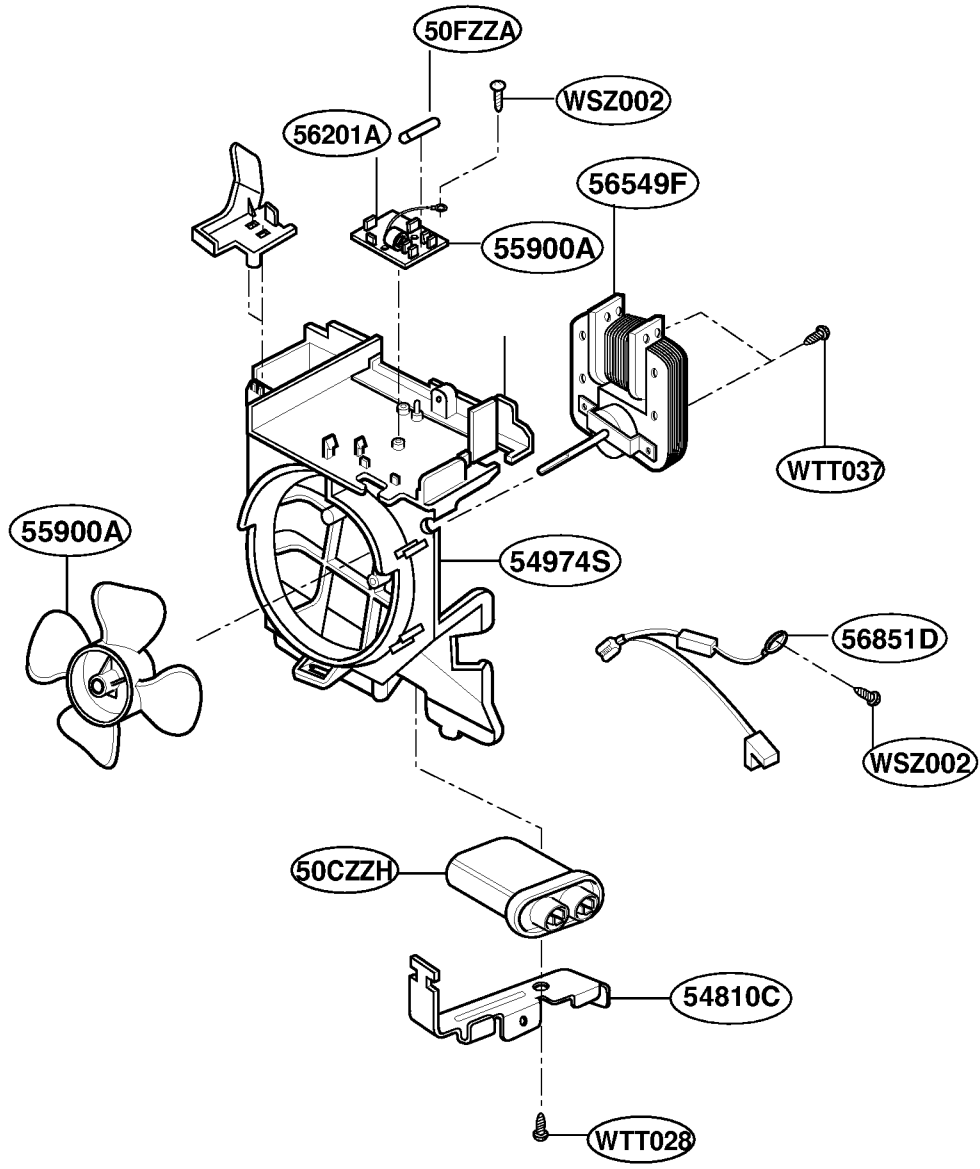

INTERIOR PARTS

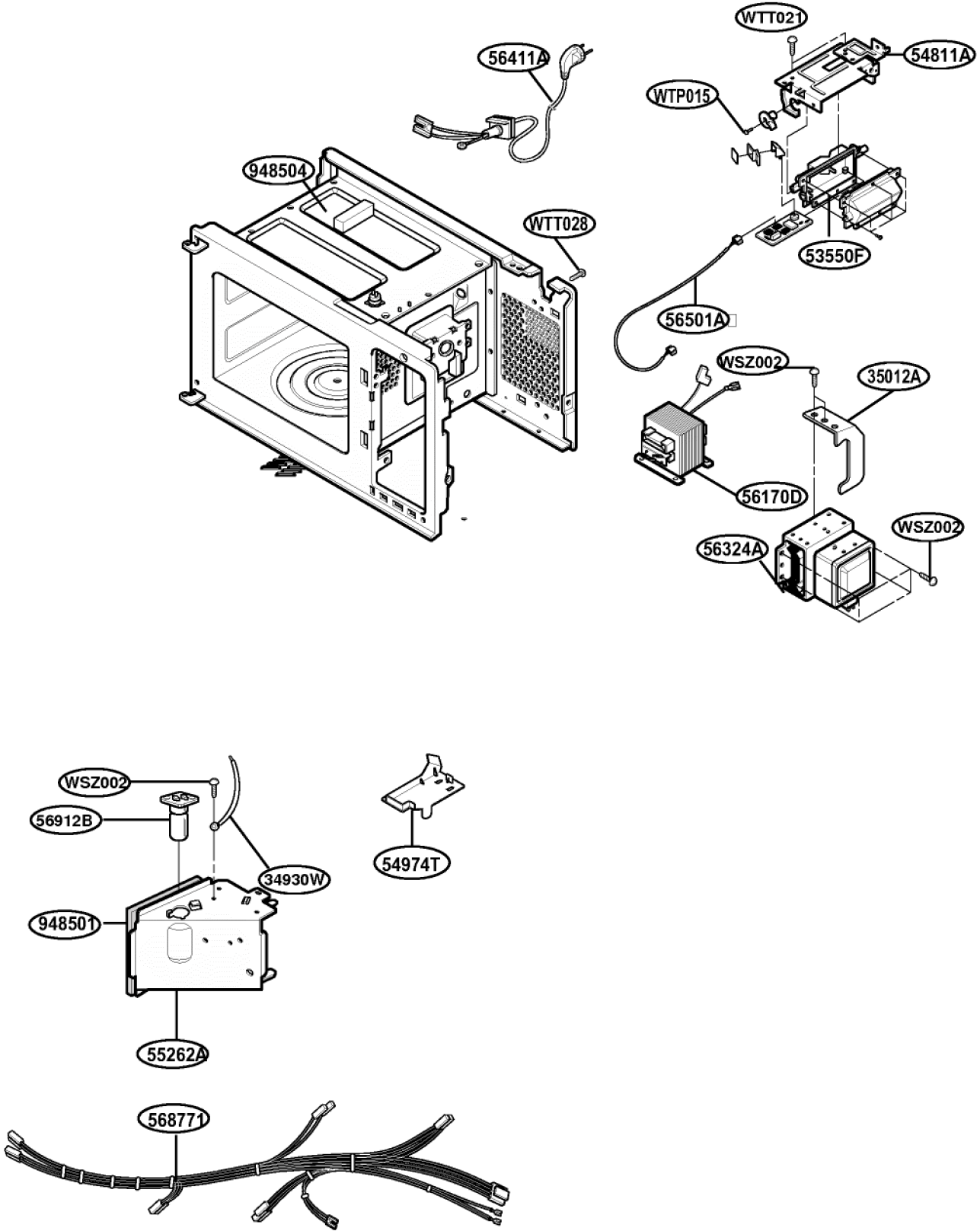

BASE PLATE PARTS

