

This Owner's Manual is provided and hosted by [Appliance Factory Parts](#).

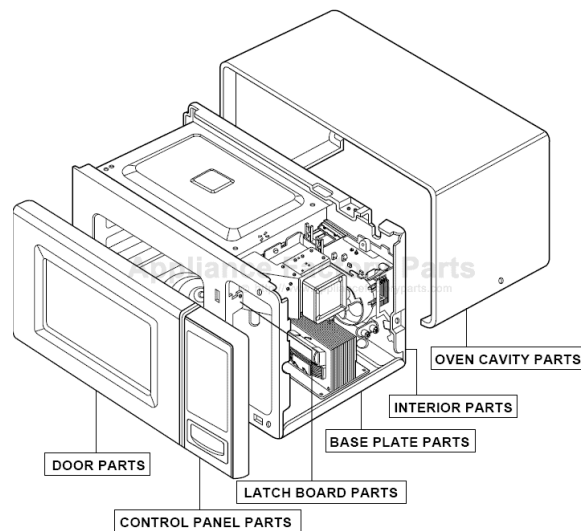

GE JE1340WB Owner's Manual

[Shop genuine replacement parts for GE JE1340WB](#)



[Find Your GE Microwave Parts - Select From 3055 Models](#)

----- Manual continues below -----

EXPLODED VIEW

INTRODUCTION

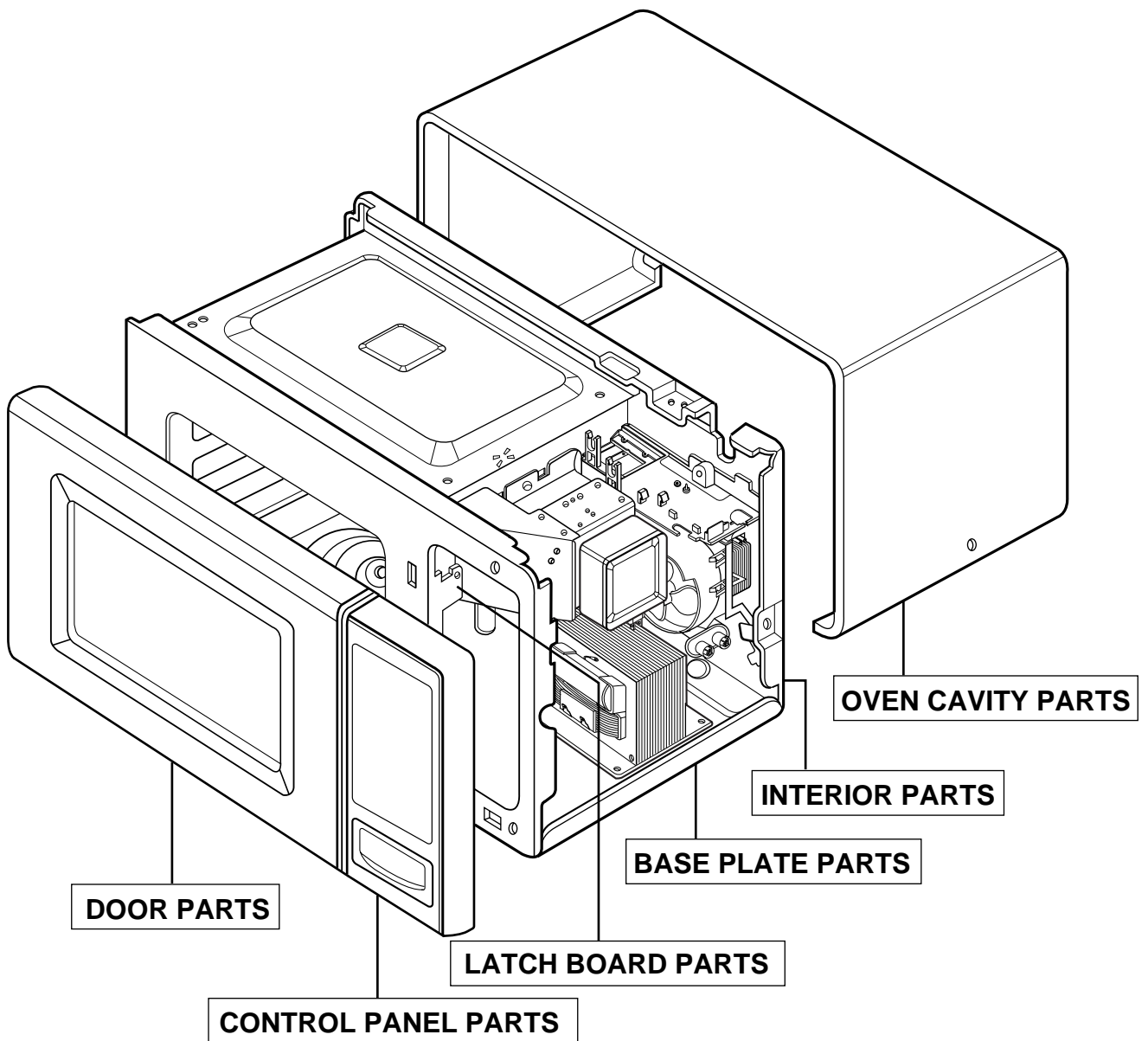

DOOR PARTS

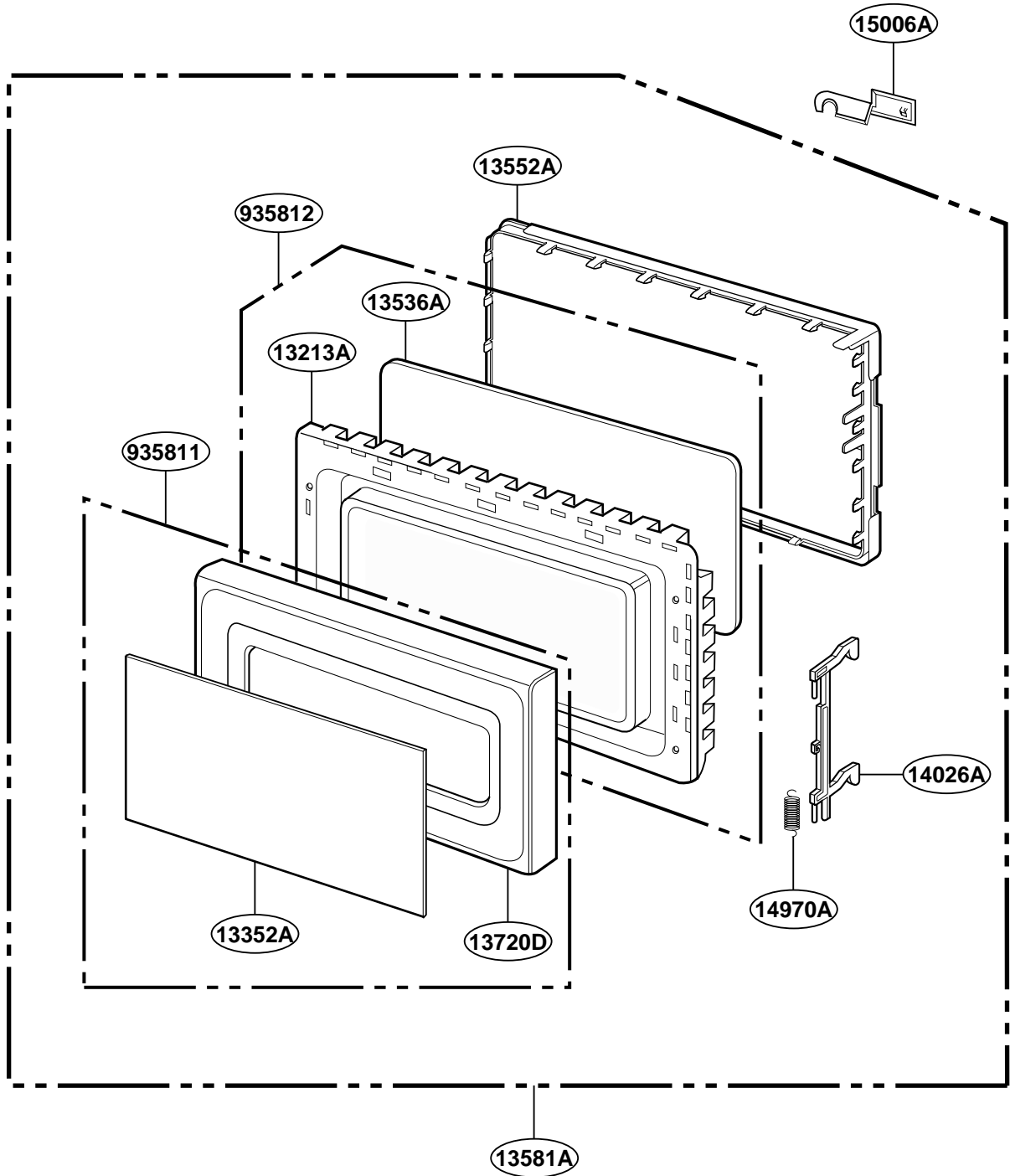

CONTROLLER PARTS

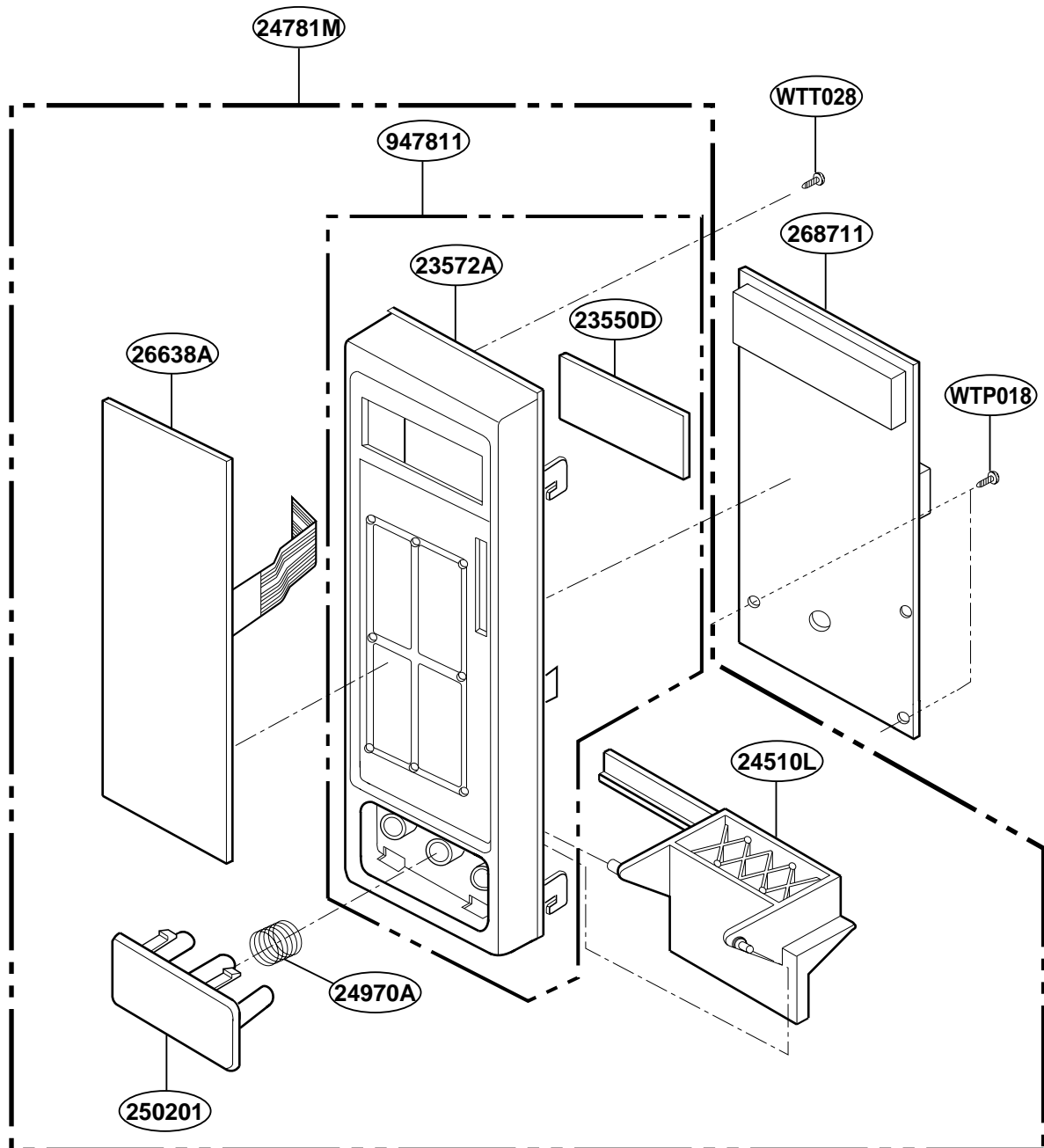

OVEN CAVITY PARTS

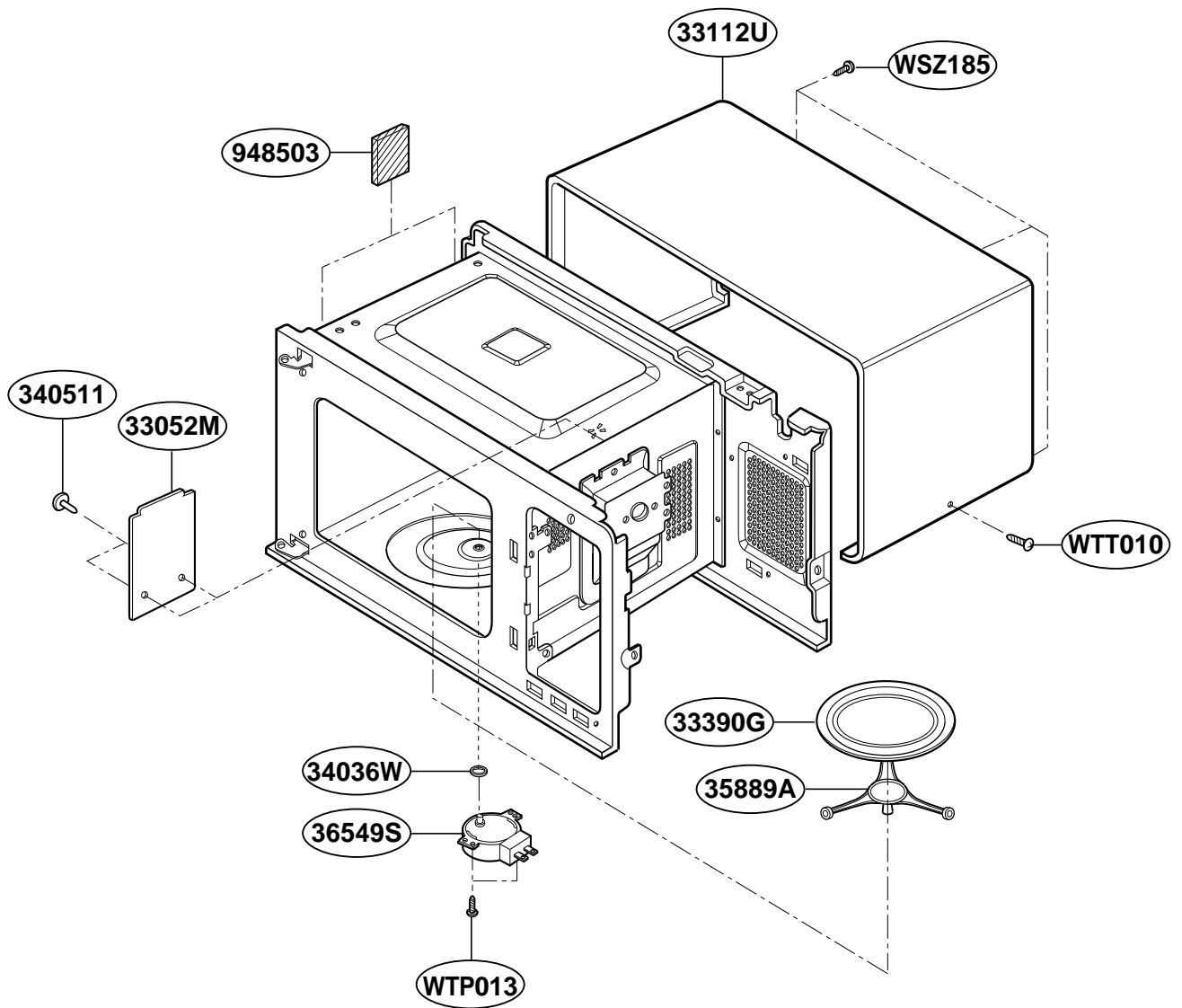

LATCH BOARD PARTS

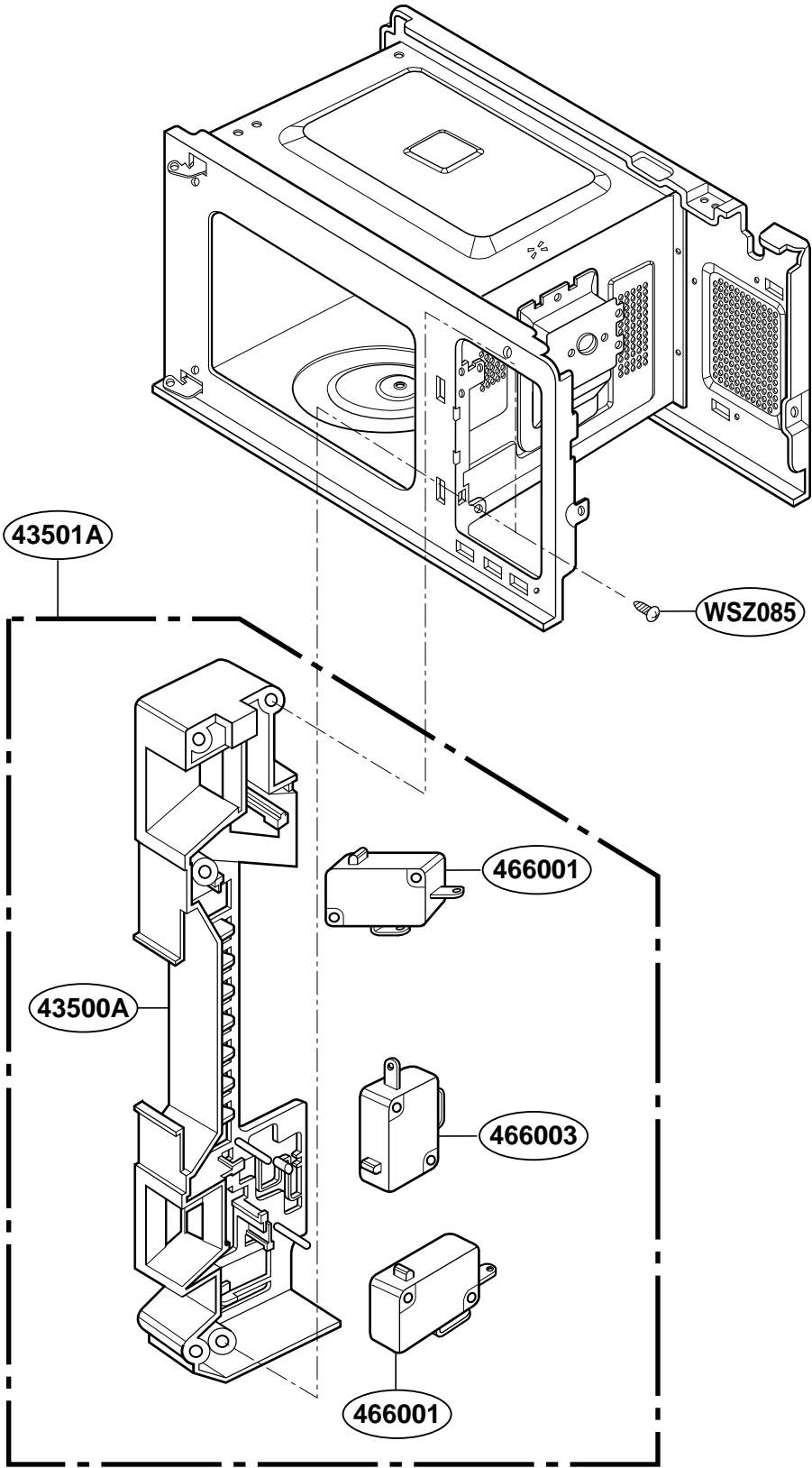

INTERIOR PARTS

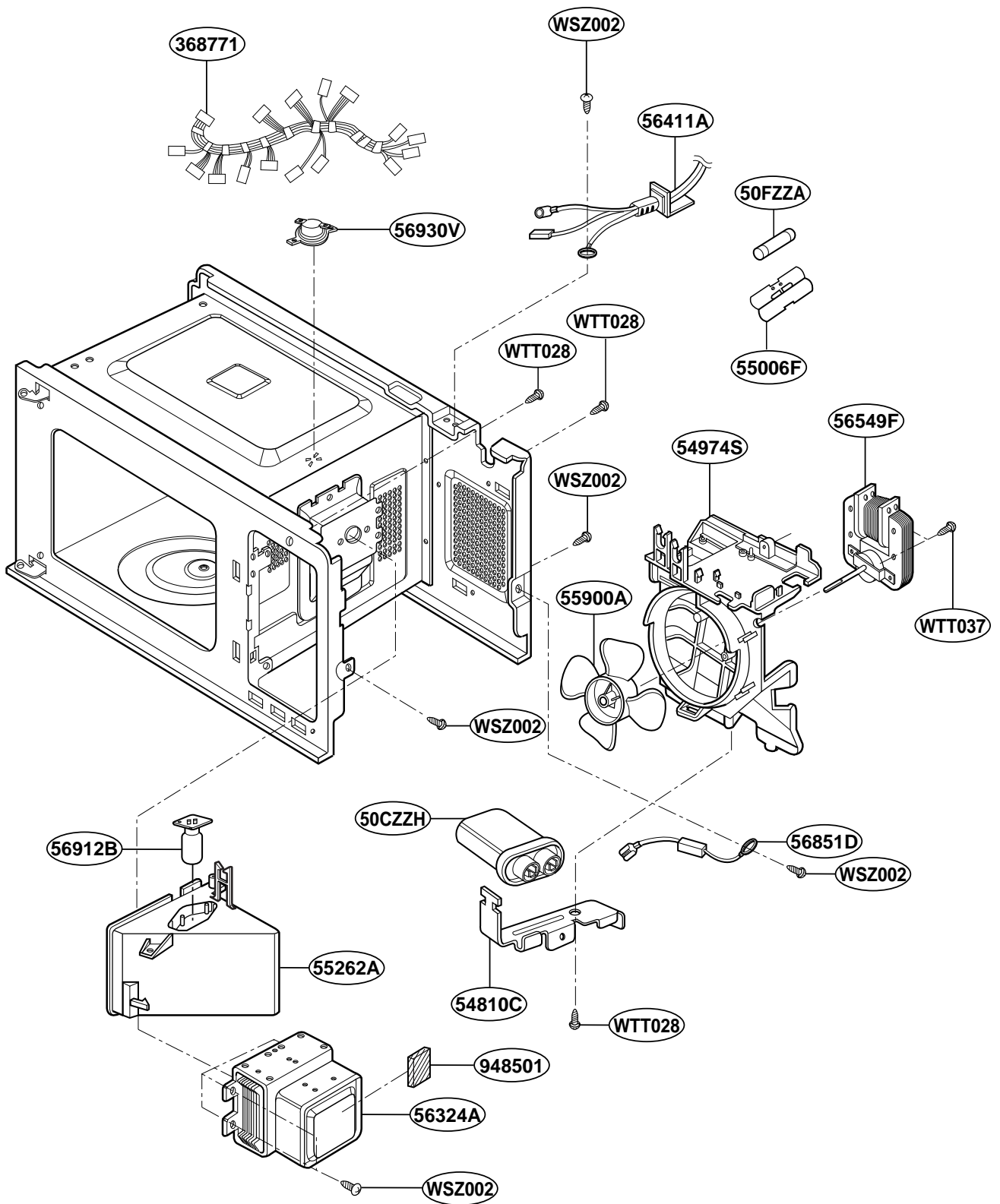

BASE PLATE PARTS

