

This Owner's Manual is provided and hosted by [Appliance Factory Parts](#).



Jenn Air JMC8130DDQ Owner's Manual

[Shop genuine replacement parts for Jenn Air
JMC8130DDQ](#)



[Find Your Jenn Air Microwave Parts - Select From 40 Models](#)

----- Manual continues below -----

EXPLODED VIEW

DOOR PARTS

For Model : JMC8127DDB/W/Q/S
JMC8130DDB/W/Q/S/R

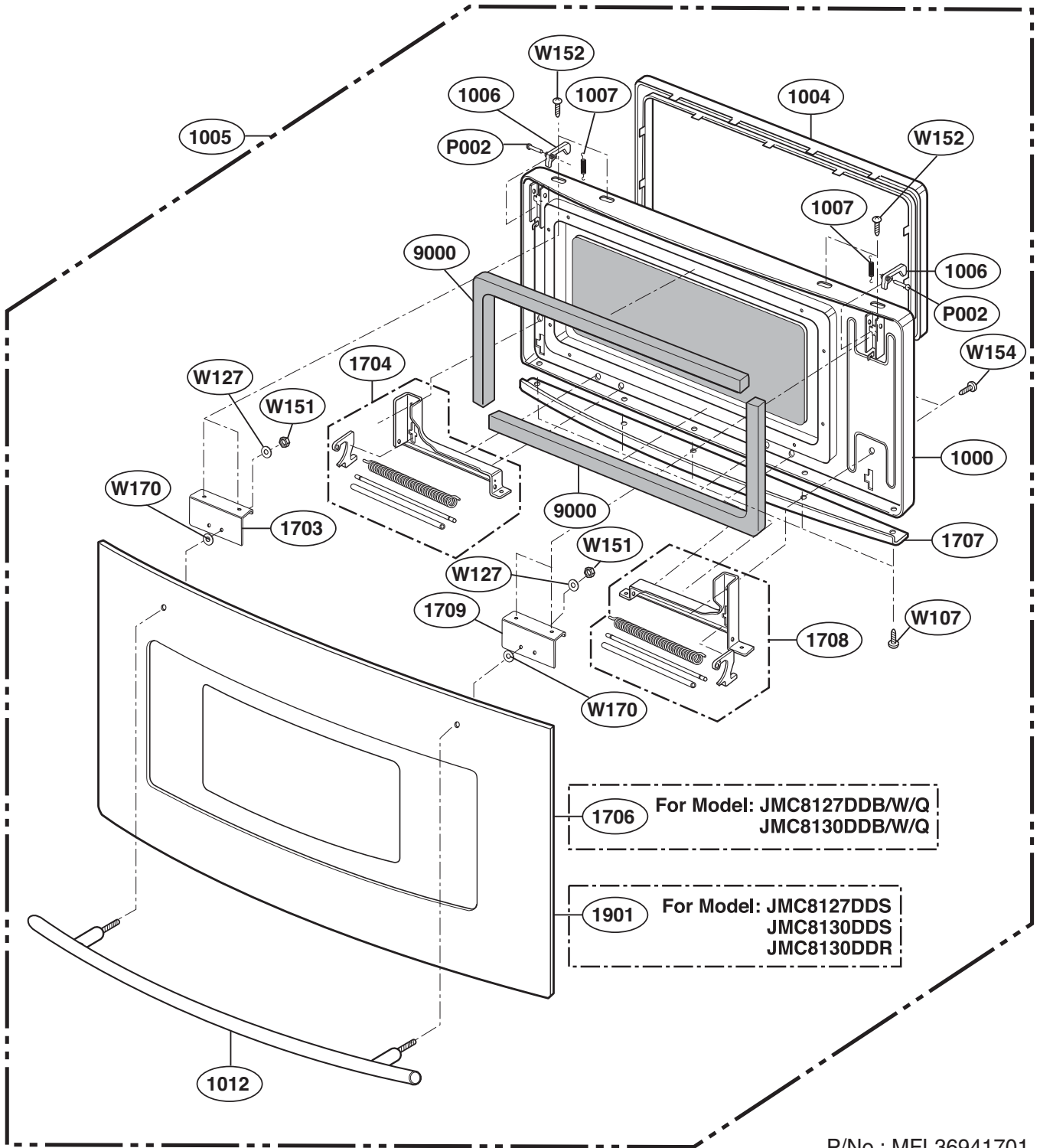

P/No.: MFL36941701

CONTROLLER PARTS

Model	Parts Name	Location #	Current	New
JMC8127DDS	Parts Assembly (Controller Assembly, Sub+Sts Cover)	2381	383EW0A030C	383EW0A030G
	PWB(PCB) Assembly, Sub	2006	6871W1S160A	6871W1S160B
JMC8127DDB	Controller Assembly, Sub	2015	4781W0A013F	4781W0A013Q
	PWB(PCB) Assembly, Sub	2006	6871W1S160A	6871W1S160B
JMC8127DDW	Controller Assembly, Sub	2015	4781W0A013G	4781W0A013R
	PWB(PCB) Assembly, Sub	2006	6871W1S160A	6871W1S160B
JMC8127DDQ	Controller Assembly, Sub	2015	4781W0A013H	4781W0A013S
	PWB(PCB) Assembly, Sub	2006	6871W1S160A	6871W1S160B
JMC8130DDS	Parts Assembly (Controller Assembly, Sub+Sts Cover)	2381	383EW0A030D	383EW0A030F
	PWB(PCB) Assembly, Sub	2006	6871W1S160A	6871W1S160B
JMC8130DDB	Controller Assembly, Sub	2015	4781W0A014F	4781W0A014Q
	PWB(PCB) Assembly, Sub	2006	6871W1S160A	6871W1S160B
JMC8130DDW	Controller Assembly, Sub	2015	4781W0A014G	4781W0A014R
	PWB(PCB) Assembly, Sub	2006	6871W1S160A	6871W1S160B
JMC8130DDQ	Controller Assembly, Sub	2015	4781W0A014H	4781W0A014S
	PWB(PCB) Assembly, Sub	2006	6871W1S160A	6871W1S160B

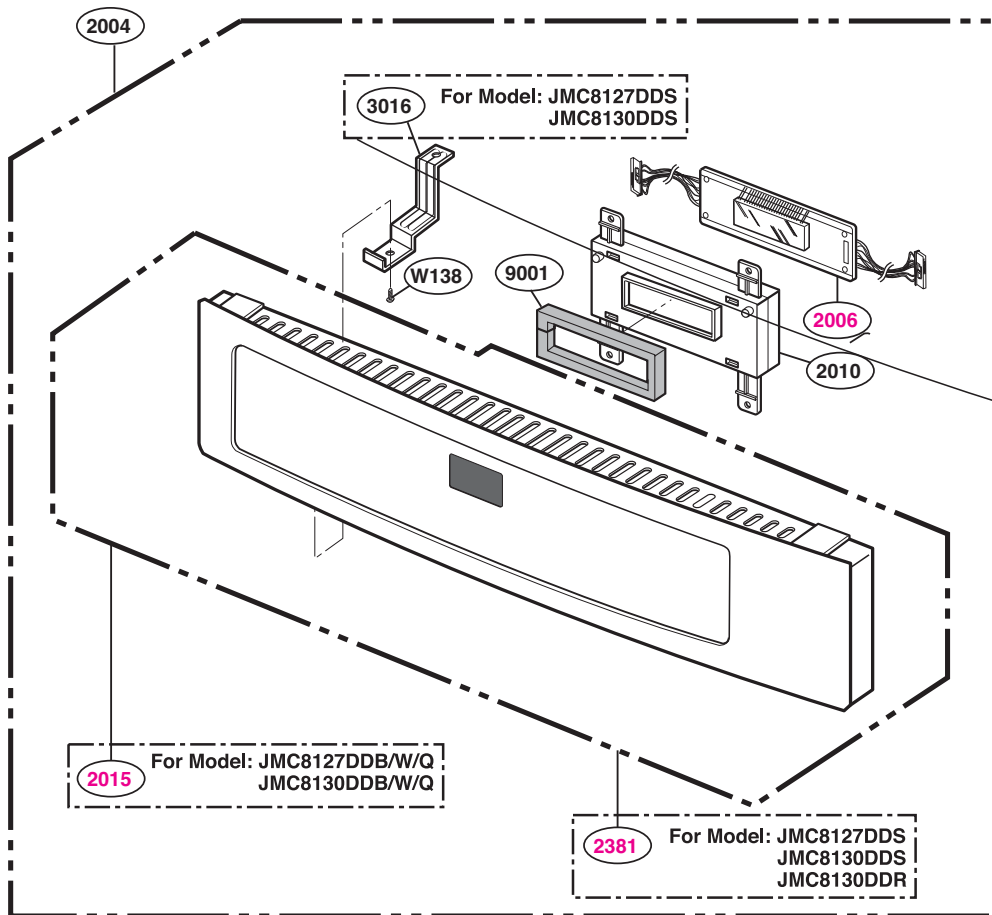

• The Pattern Design for the PCB Board is Modified Partially to improve productivity.

- Changed the part in PCB Board & Control Panel.
(2006) (2381 or 2015)

- New parts only may be used in early or late production sets.
(Stock New parts)

OVEN CAVITY PARTS

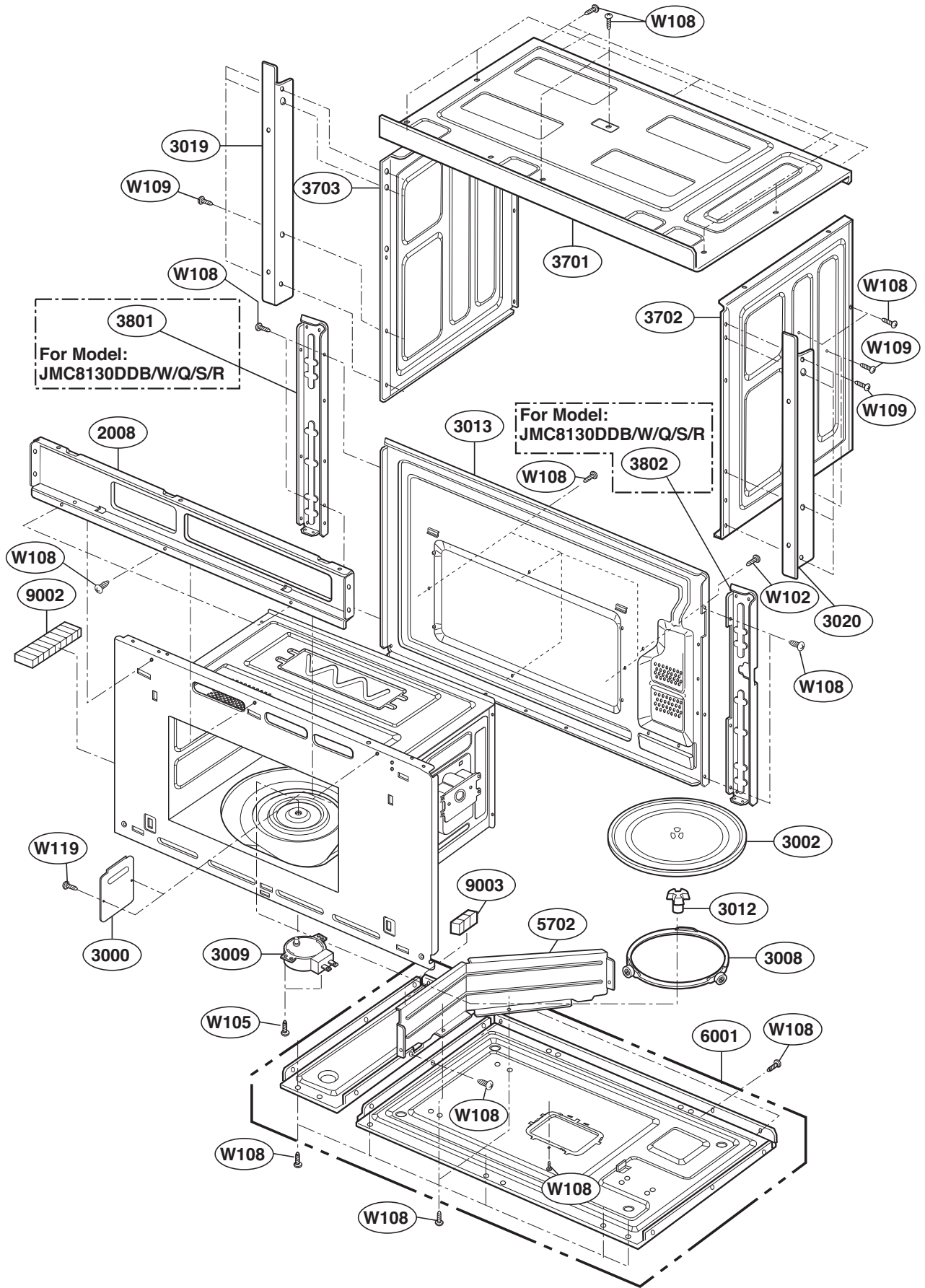

LATCH BOARD PARTS

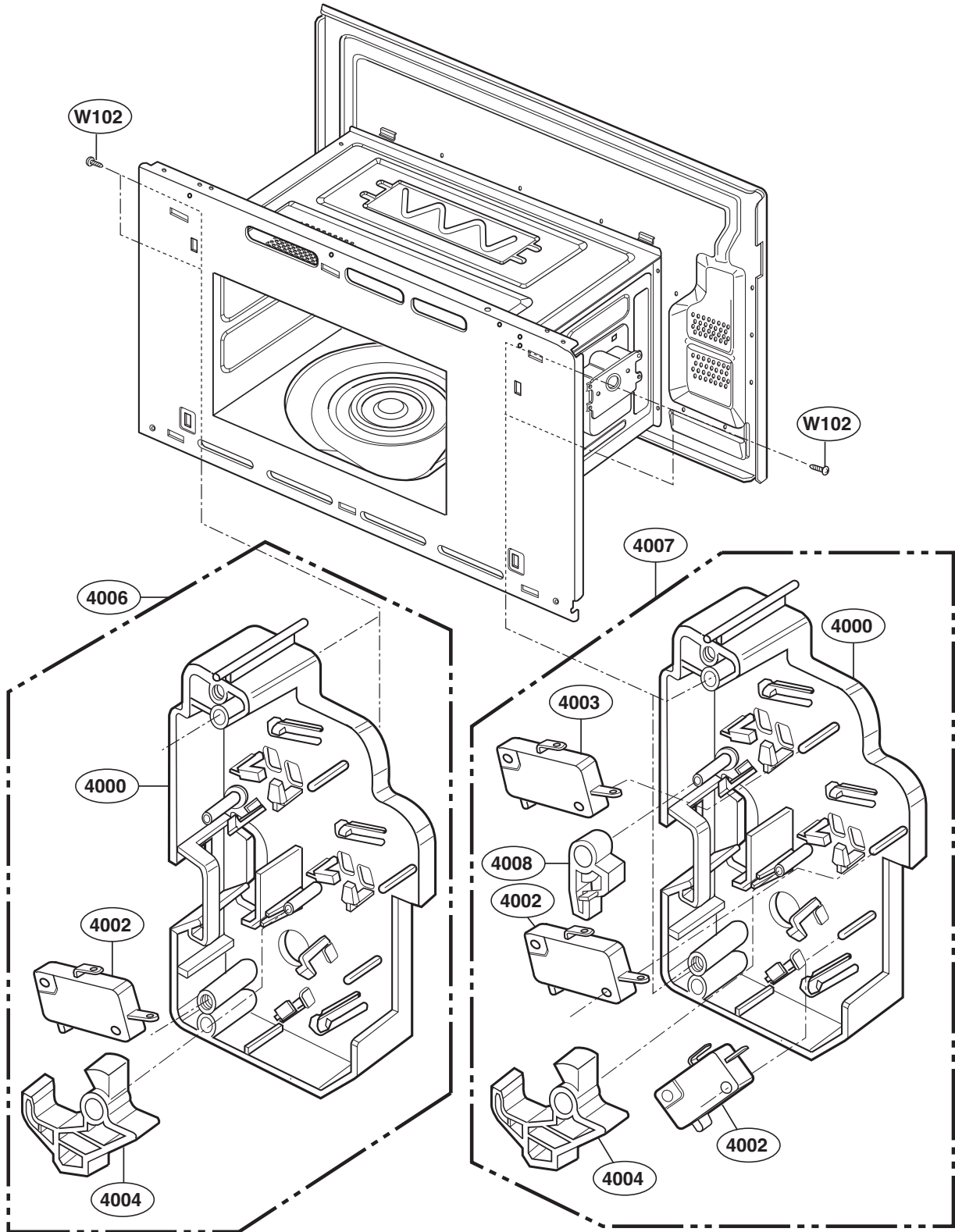

INTERIOR PARTS (I)

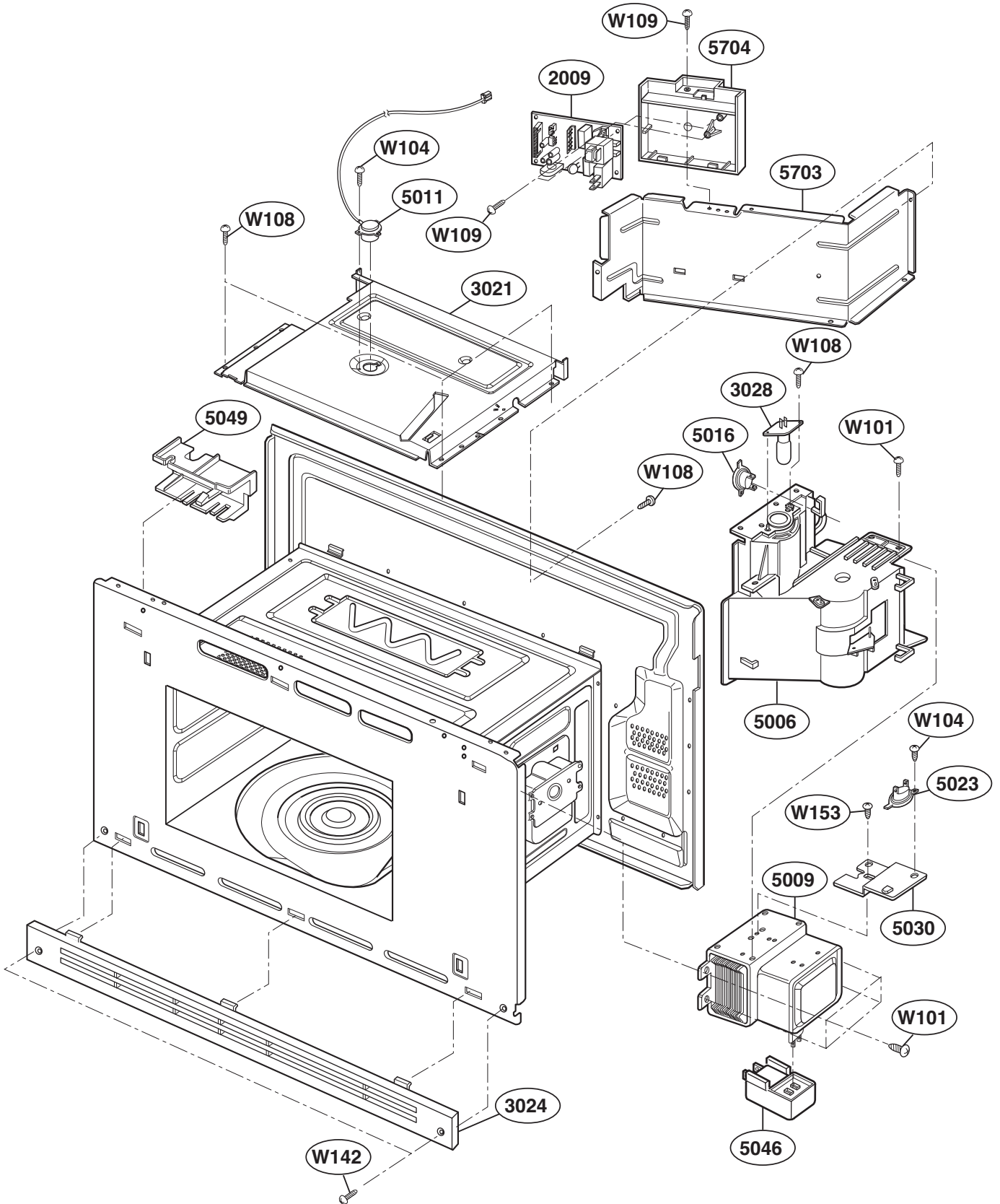

INTERIOR PARTS (II)

