

# GoldStar

# MICROWAVE OVEN SERVICE MANUAL

## CAUTION

BEFORE SERVICING THE UNIT, READ THE  
SAFETY PRECAUTIONS IN THIS MANUAL.

**MODEL: MA-972M**  
**MA-972MW**

# SAFETY PRECAUTIONS

This device is to be serviced only by properly qualified service personnel.

Consult the service manual for proper service procedures to assure continued safety operation and for precautions to be taken to avoid possible exposure to excessive microwave energy.

## **PRECAUTIONS TO BE OBSERVED BEFORE AND DURING SERVICING TO AVOID POSSIBLE EXPOSURE TO EXCESSIVE MICROWAVE ENERGY**

- A) Do not operate or allow the oven to be operated with the door open.
- B) Make the following safety checks on all ovens to be serviced before activating the magnetron or other microwave source, and make repairs as necessary; (1) Interlock operation, (2) proper door closing, (3) seal and sealing surfaces (arcing, wear, and other damage), (4) damage to or loosening of hinges and latches, (5) evidence of dropping or abuse.
- C) Before turning on microwave power for any service test or inspection within the microwave generating compartments, check the magnetron, wave guide or transmission line, and cavity for proper alignment, integrity, and connections.
- D) Any defective or misadjusted components in the interlock, monitor, door seal, and microwave generation and transmission systems shall be repaired, replaced, or adjusted by procedures described in this manual before the oven is released to the owner.
- E) A microwave leakage check to verify compliance with the Federal Performance Standard should be performed on each oven prior to release to the owner.

# TABLE OF CONTENTS

(Page)

<b>SAFETY PRECAUTIONS</b> .....	<b>Inside front cover</b>
<b>SPECIFICATIONS</b> .....	<b>1-1</b>
<b>CAUTIONS</b> .....	<b>2-1</b>
<b>INSTALLATIONS</b> .....	<b>3-1</b>
<b>OPERATING INSTRUCTIONS</b> .....	<b>4-1</b>
FEATURES .....	4-1
CONTROL PANEL .....	4-1
OPERATING SEQUENCE .....	4-2
SCHEMATIC DIAGRAM .....	4-3
CIRCUIT DESCRIPTION .....	4-4
<b>SERVICE INFORMATION</b> .....	<b>5-1</b>
TOOLS AND MEASURING INSTRUMENTS .....	5-1
MICROWAVE LEAKAGE TEST .....	5-1
MEASUREMENT OF MICROWAVE POWER OUTPUT .....	5-3
DISASSEMBLY AND ADJUSTMENT .....	5-3
INTERLOCK CONTINUITY TEST .....	5-7
COMPONENT TEST PROCEDURE .....	5-8
TROUBLE SHOOTING .....	5-11
<b>EXPLODED VIEW</b> .....	<b>6-1</b>
<b>REPLACEMENT PARTS LIST</b> .....	<b>7-1</b>
<b>SCHEMATIC DIAGRAM OF P.C.B.</b> .....	<b>8-1</b>
PRINTED CIRCUIT BOARD .....	8-2
<b>P.C.B. PARTS LIST</b> .....	<b>9-1</b>

# SPECIFICATION

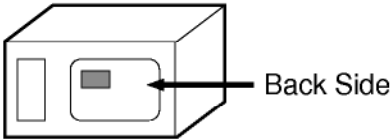
ITEM	DESCRIPTIONS
<b>MODEL</b>	<b>MA-972M, MA-972MW</b>
Power Requirement	120 V AC, 60Hz 1,500 W (13.5A) Single phase, 3 wire grounded
Power Output	1000 Watts full microwave power (IEC705)
Microwave Frequency	2,450MHz
Magnetron	2M246
Timer	0 - 99min. 99sec.
Outside Dimensions	20"(W) x 11 <sup>3</sup> / <sub>4</sub> "(H) x 14 <sup>3</sup> / <sub>4</sub> "(D)
Cavity Dimensions	13 <sup>1</sup> / <sub>4</sub> "(W) x 8"(H) x 14 <sup>1</sup> / <sub>2</sub> "(D)
Net Weight	38 lbs (approx.)
Shipping weight	41 lbs (approx.)
Control Complement	Touch Control System Clock : 1:00 - 12:59 Microwave Power for Variable Cooking Power level HIGH ----- Full power throughout the cooking time 9(Sauté) ----- approx. 90% of Full power, 8(Reheat) ----- approx. 80% 7(Med.-High) ----- approx. 70%, 6(Medium) ----- approx. 60% 5(Med.-Low) ----- approx. 50%, 4(Defrost) ----- approx. 40% 3(Low) ----- approx. 30%, 2(Simmer) ----- approx. 20% 1(Warm) ----- approx. 10%
Nameplate Location	
Accessories	Owner's manual & cooking guide Glass turntable Rotating ring
<p>This microwave oven is designed for household use only. It is not recommended for commercial purpose.</p>	

# CAUTIONS

Unlike other appliances, the microwave oven is high-voltage and high-current equipment. Though it is free from danger in ordinary use, extreme care should be taken during repair.

- DO NOT operate on a 2-wire extension cord during repair and use.
- NEVER TOUCH any oven components or wiring during operation.
- BEFORE TOUCHING any parts of the oven, always remove the power plug from the outlet.
- For about 30 seconds after the oven stops, an electric charge remains in the high voltage capacitor. When replacing or checking, you must discharge the high voltage capacitor by shorting across the two terminals with an insulated screwdriver.

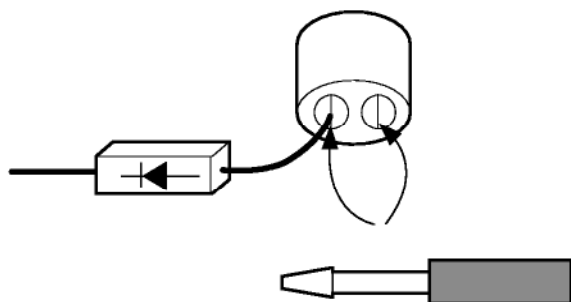

- Remove your watches whenever working close to or replacing the Magnetron.
- DO NOT touch any parts of the control panel circuit. A resulting static electric discharge may damage this P.C.B.
- NEVER operate the oven with no load.
- NEVER injure the door seal and front plate of the oven cavity.
- NEVER put iron tools on the magnetron.
- NEVER put anything into the latch hole and the interlock switches area.

## MICROWAVE RADIATION

Personnel should not be exposed to the microwave energy which may radiate from the magnetron or other microwave generating device if it is improperly used or connection. All input and output microwave connections, waveguide, flange, and gasket must be secure never operate the device without a microwave energy absorbing load attached. Never look into an open waveguide or antenna while the device is energized.

- Proper operation of the microwave oven requires that the magnetron be assembled to the waveguide and cavity. Never operate the magnetron unless it is properly installed.
- **Be sure that the magnetron gasket is properly installed around the dome of the tube whenever installing the magnetron.**

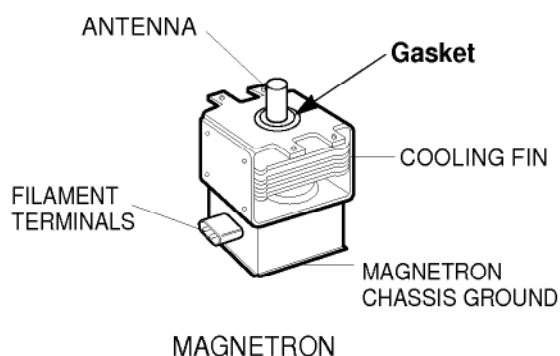

**THE OVEN IS TO BE SERVICED ONLY BY PROPERLY QUALIFIED SERVICE PERSONNEL.**

# INSTALLATIONS

**BEFORE YOU BEGIN, READ THE FOLLOWING INSTRUCTIONS COMPLETELY AND CAREFULLY.**

## Installing microwave oven

1. Empty the microwave oven and clean inside it with a soft, damp cloth. Check for damage such as misaligned door, damage around the door or dents inside the cavity or on the exterior.
2. Put the oven on a counter, table or shelf that is strong enough to hold the oven and the food and utensils you put in it. (The control panel side of the oven is the heavy side. Use care when handling.)
3. Do not block the vent and the air intake openings. Blocking vent or air intake openings can cause damage to the oven and poor cooking results. Make sure the microwave oven legs are in place to ensure proper air flow.
4. The oven should not be installed in any area where heat and steam are generated, because they may damage the electronic or mechanical parts of the unit. Do not install the oven next to a conventional surface unit or above a conventional wall oven.
5. Use microwave oven in an ambient temperature less than 104°F (40°C).
6. Place the microwave oven on a sturdy and flat surface, at least 10 Cm (4 inches) from the wall.
7. Place the microwave oven as far away as possible from TV, RADIO, COMPUTER, etc., to prevent interference.

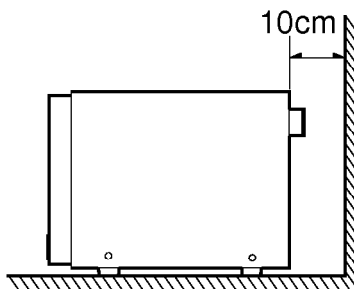

## Grounding Instructions

For personal safety, this appliance must be fully grounded at all times. In the event of an electrical short circuit, grounding reduces the risk of electrical shock. The plug must be plugged into an outlet that is properly installed and grounded.

### WARNING

Improper use of the grounding plug can result in a risk of electric shock. Do not, under any circumstances, cut or remove the third ground prong from the power cord plug.

PREFERRED METHOD

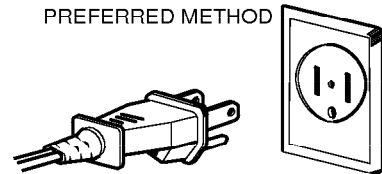

INSURE PROPER GROUND EXISTS BEFORE USE

TEMPORARY METHOD  
(ADAPTER PLUGS ARE NOT PERMITTED IN CANADA)  
ALIGN LARGE PRONGS/SLOTS

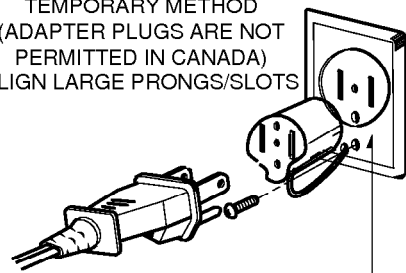

INSURE PROPER GROUND AND FIRM CONNECTION BEFORE USE

# OPERATING INSTRUCTIONS

## Features

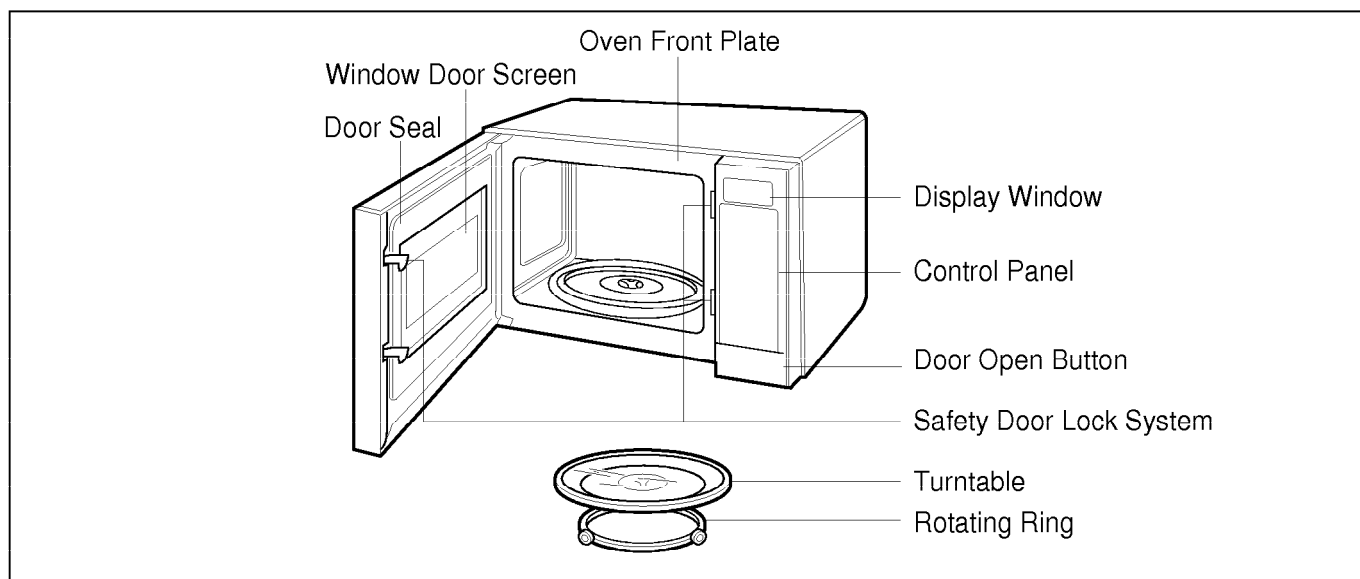

## Control Panel

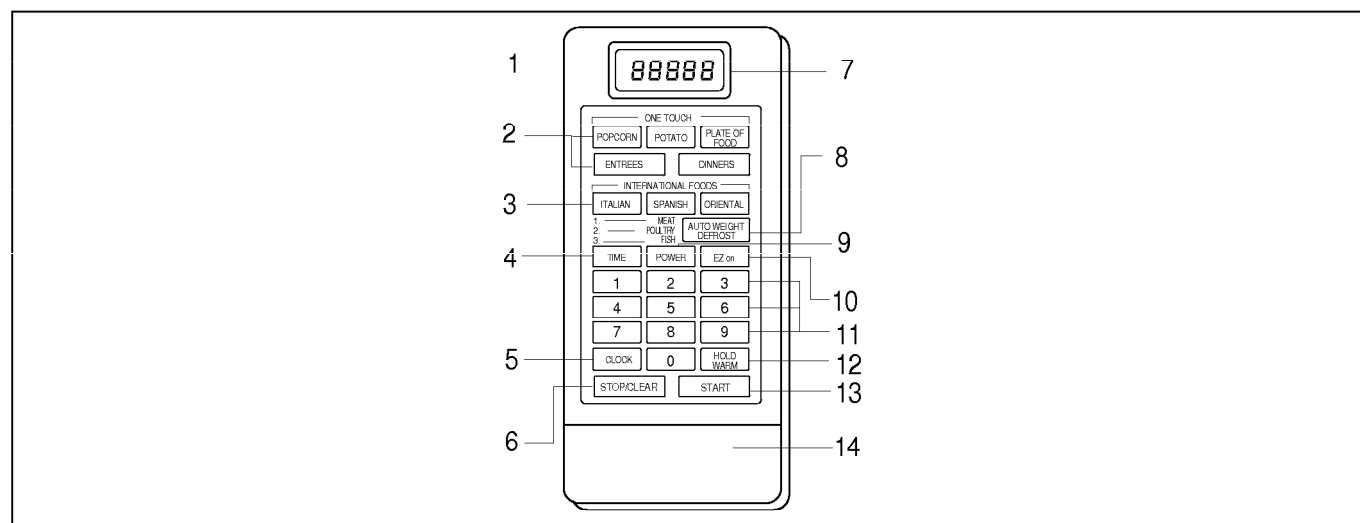

1. INDICATORS
2. ONE TOUCH CONTROL : Used to cook the foods listed by one touch.
3. INTERNATIONAL FOODS
4. TIME : Used these pads to set the cooking time.
5. CLOCK : Use to set the time of day.
6. STOP/CLEAR :Used to stop oven and clear all entries except time of day.
7. DISPLAY WINDOW
8. AUTO WEIGHT DEFROST : Used to select the desired auto weight defrost programmed with weight pad.
9. POWER : Used in selected the desired power level for cooking.
10. EZ on : Used to set quickly and start without the need to touch START.
11. NUMBER: Used to set for Time of day, Cooking time, Power level or Defrost weight.
12. HOLD WARM : Used to keep the food warm after the cooking is done.
13. START : One tap allows oven to begin functioning.
14. DOOR OPEN BUTTON : Press to open the door. Opening the door during cooking will stop the oven.

# Operating Sequence

The followings are description of component functions during oven operation.

## 1. Setting the clock

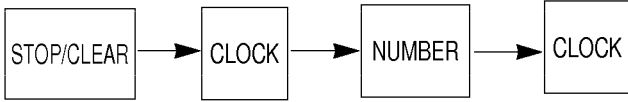

ex) To set 4:30, touch number key [4],[3], and [0].

NOTE: 1) This is a 12 hour clock.

2) Clock will operate as long as power is applied to the oven.

## 2. Cancel function

Touch the **STOP/CLEAR** pad whenever you need to cancel an entry or a function currently is use.

The display will either return to the last item entered, or return to the clock.

## 3. Child lock

This oven has a CHILD LOCK feature.

TO SET CHILD LOCK

Touch the **STOP/CLEAR** pad.

- Touch and hold "0" pad → "LOCK" appear on the display.

You can't input any key except "0" key.

TO CANCEL CHILD LOCK

Touch the **STOP/CLEAR** pad.

- Touch and hold "0" pad → "LOCK" disappears.

## 4. Time Cooking

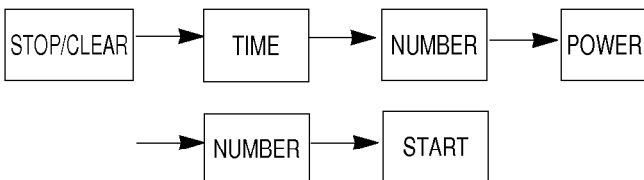

## 5. Multi Stage Cooking

1st stage

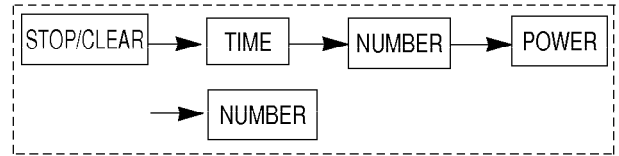

2nd stage

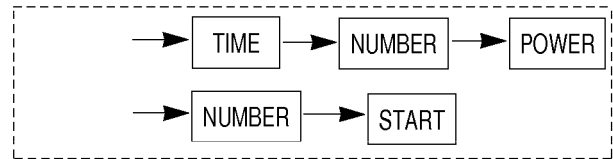

## 6. Auto Weight Defrost

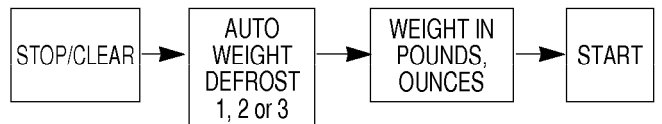

## 7. One Touch & International Foods Cooking

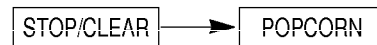

NOTE : Heat only 1 package at a time.



# SCHEMATIC DIAGRAM

## MICROWAVE OVEN

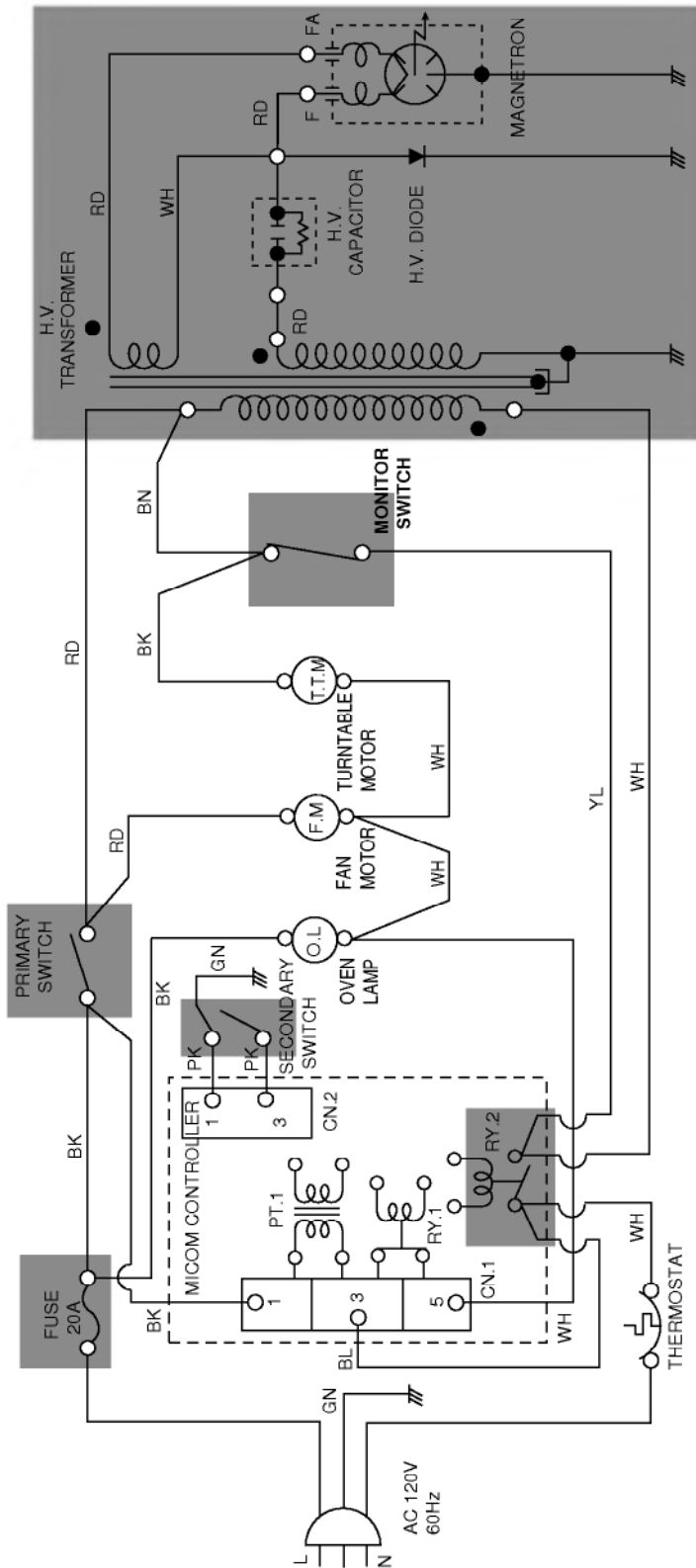

NOTE : DOOR IS OPENED.

BN : BROWN    BL : BLUE    YL : YELLOW    PK : PINK  
 RD : RED      BK : BLACK    WH : WHITE

IMPORTANT SAFETY NOTE: THE SHADED AREA ON THIS SCHEMATIC DIAGRAM INCORPORATES SPECIAL FEATURES IMPORTANT FOR PROTECTION FROM MICROWAVE RADIATION, FIRE, AND ELECTRICAL SHOCK HAZARDS. WHEN SERVICING, IT IS ESSENTIAL THAT ONLY MANUFACTURERS SPECIFIED PARTS BE USED FOR THE CRITICAL COMPONENTS IN THE SHADED AREAS OF THE SCHEMATIC DIAGRAM.

NOTICE: SINCE THIS IS BASIC SCHEMATIC DIAGRAM, THE VALUES OF COMPONENTS AND SOME PARTIAL CONNECTIONS ARE SUBJECT TO CHANGE FOR IMPROVEMENT.

# Circuit Description

- The low voltage transformer supplies the necessary voltage to the micom controller when power cord is plugged in.
- When door is closed, the primary switch is ON, the secondary switch is ON, and the monitor switch is connect the main line(contact COM and NO).

## WHEN COOKING POWER LEVEL AND COOKING TIME SET BY SELECTING

- The micom controller memorizes the function you set.
- The time you set appears in the display window.
- Each indicator light turns on to indicate that the stage has been set.

## WHEN TOUCHING THE START PAD

- The coil of the relay is energized by micom controller.
- Power input is supplied to the high voltage transformer through the primary switch, relay 2 and monitor switch.
- Turntable rotates.

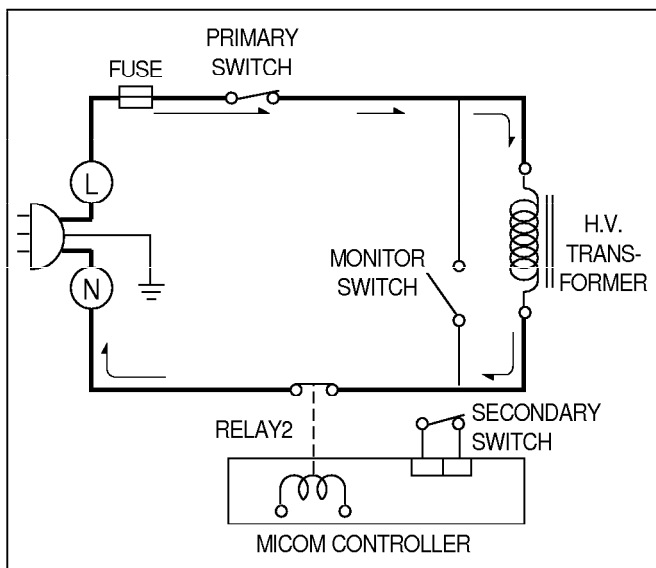

- The fan motor rotates and cools the magnetron by blowing the air (coming from the intake on the backplate) over the magnetron.
- The air is also directed into the oven to exhaust the vapor in the oven through the upper plate.
- Cooking time starts counting down.
- 3.2 volts AC is generated from the filament winding of the high voltage transformer. This 3.2 volts is applied to the magnetron to heat the magnetron filament through two noise-preventing choke coils.

- A high voltage of approximately 2100 volts AC is generated in the secondary of the high voltage transformer which is increased by the action of the high voltage diode and charging of the high voltage capacitor.
- The negative 4,000 Volts DC is applied to the filament of the magnetron.

## WHEN THE OVEN IS SET AT ANY LEVEL EXCEPT MAXIMUM.

- The micom controller controls the ON-OFF time of relay 2 by the applied signal to vary the average output power of microwave oven as POWER LEVEL. (refer to page 1-1)
- One complete cycle of relay 2 is 22 seconds.

## WHEN THE DOOR IS OPENED DURING COOKING

- Both primary switch and relay 2 will cut off primary winding voltage of the high voltage transformer.
- ON-OFF of relay 2 is coupled electrically with opening and closing of secondary switch.
- When the door is opened, secondary switch is opened and when the door is closed, secondary switch is closed.
- The cooking time stops counting down.
- Relay stops functioning.
- As the door is opened, if the contact of primary switch fails to open, the fuse opens due to the large current surge caused by the monitor switch activation which, in turn, stops magnetron oscillation.

