

This Owner's Manual is provided and hosted by [Appliance Factory Parts](http://www.appliancefactoryparts.com).



WHIRLPOOL MH6150XHT-2 Owner's Manual

[Shop genuine replacement parts for WHIRLPOOL
MH6150XHT-2](#)

DOOR PARTS

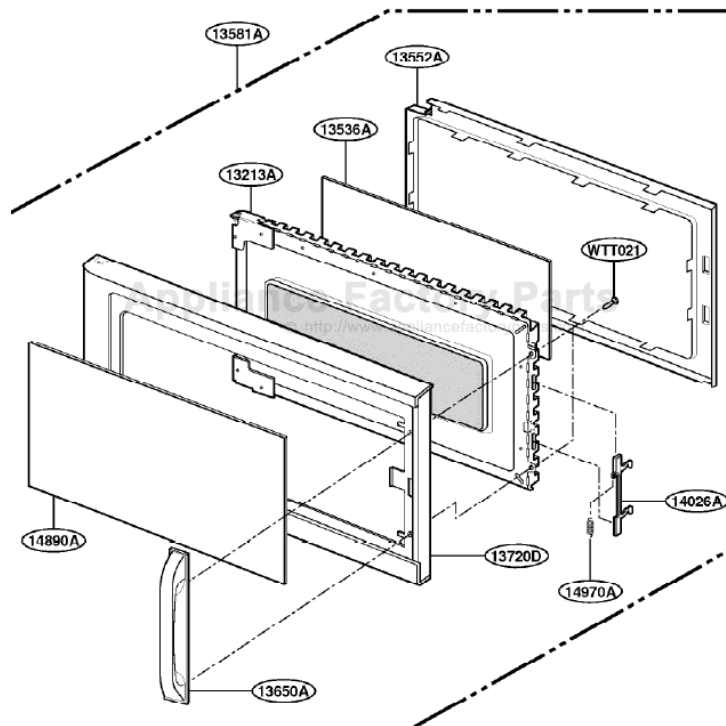

[Find Your WHIRLPOOL Microwave Parts - Select From 1350 Models](#)

----- Manual continues below -----

EXPLODED VIEW

MODEL : MH6150XH

DOOR PARTS

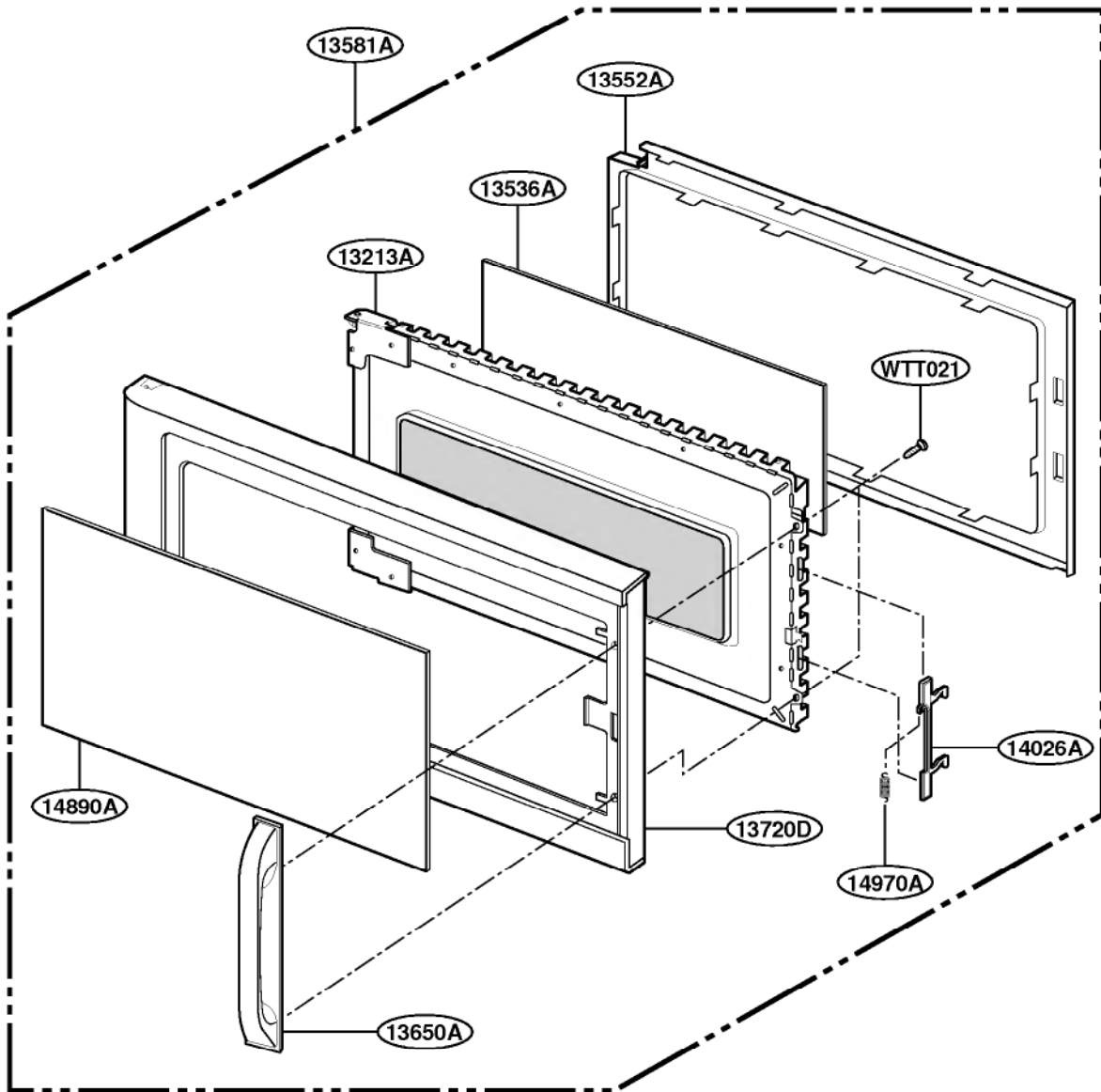

CONTROLLER PARTS

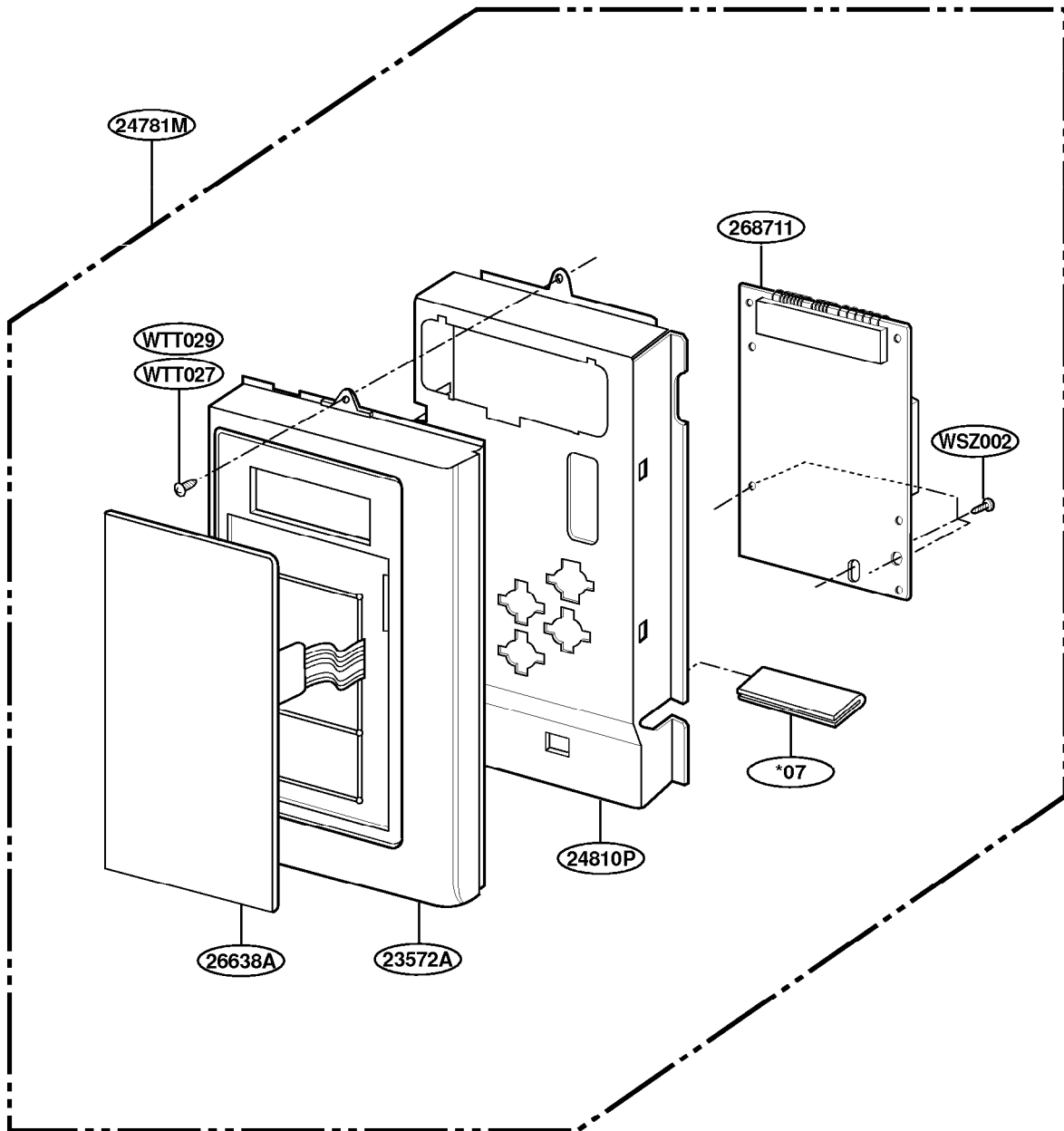

OVEN CAVITY PARTS

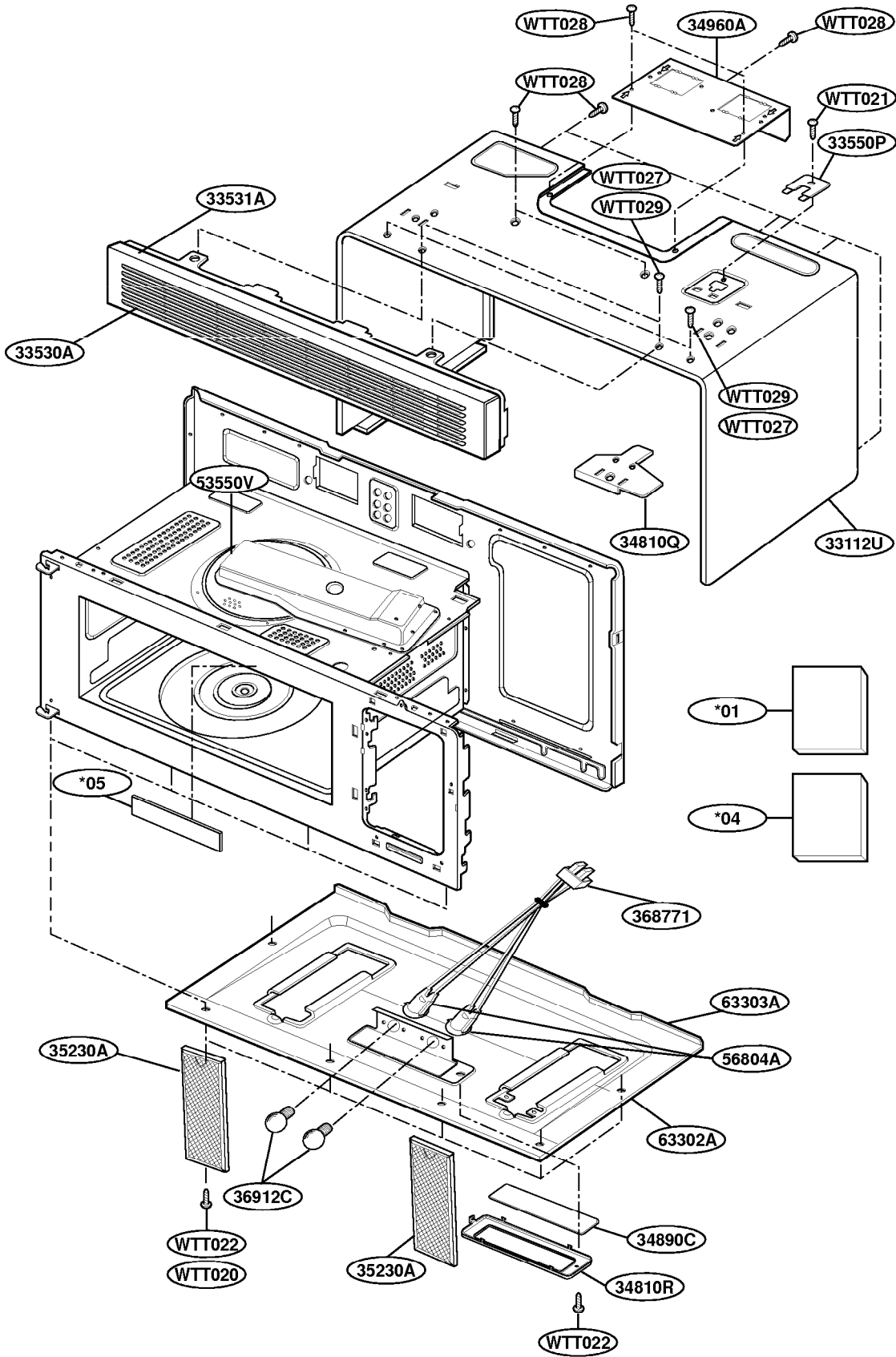

LATCH BOARD PARTS

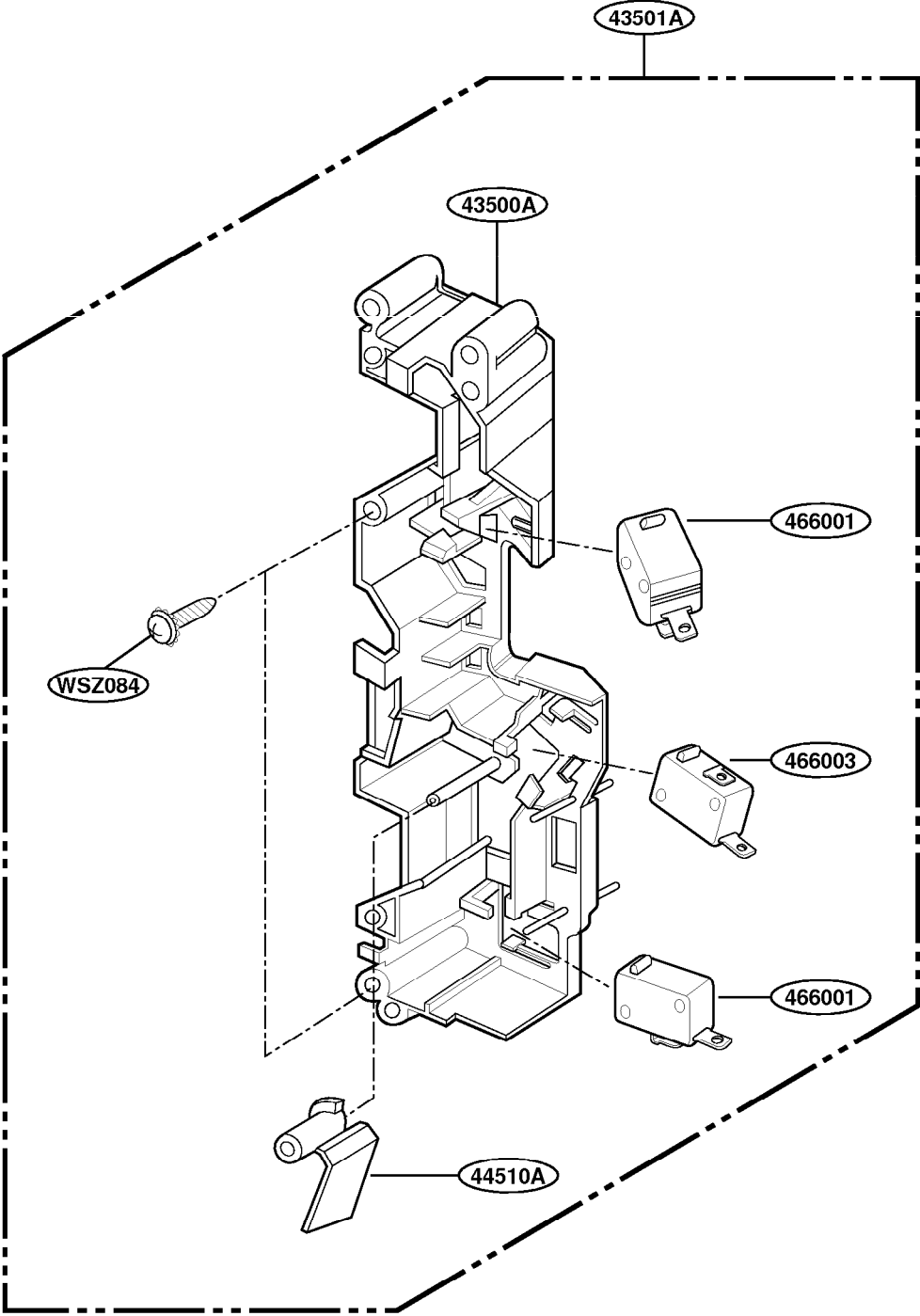

INTERIOR PARTS (II)

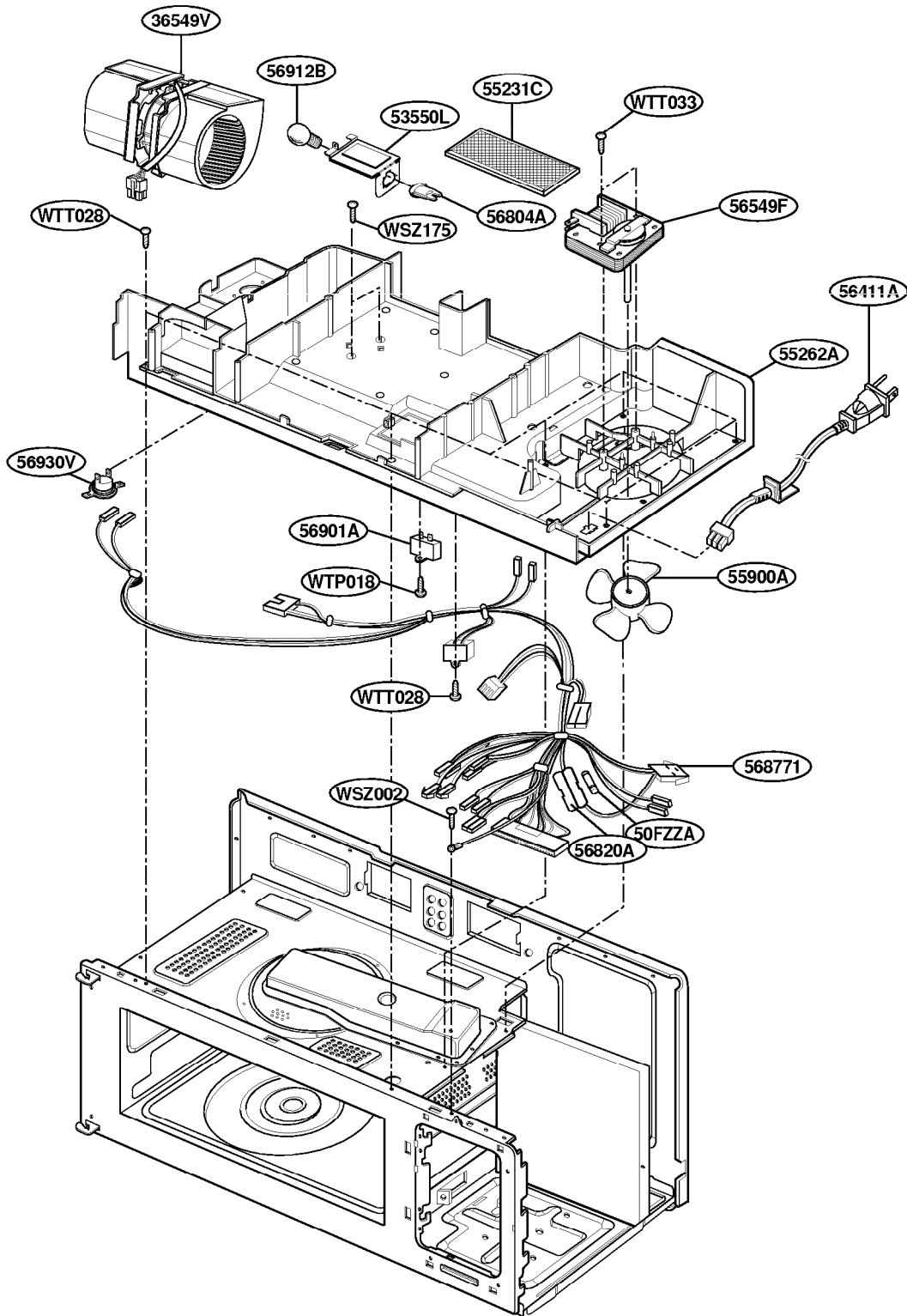

INSTALLATION PARTS

