

This Owner's Manual is provided and hosted by [Appliance Factory Parts](http://www.appliancefactoryparts.com).



# WHIRLPOOL MH6151XHT-1 Owner's Manual

[Shop genuine replacement parts for WHIRLPOOL  
MH6151XHT-1](#)

## DOOR PARTS

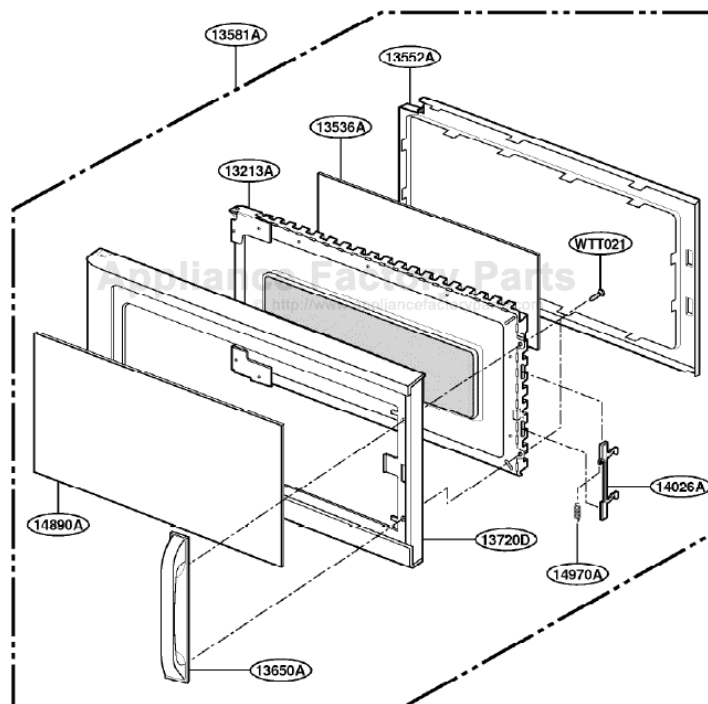

[Find Your WHIRLPOOL Microwave Parts - Select From 1350 Models](#)

----- Manual continues below -----

# EXPLODED VIEW

MODEL : MH6151XH

## DOOR PARTS

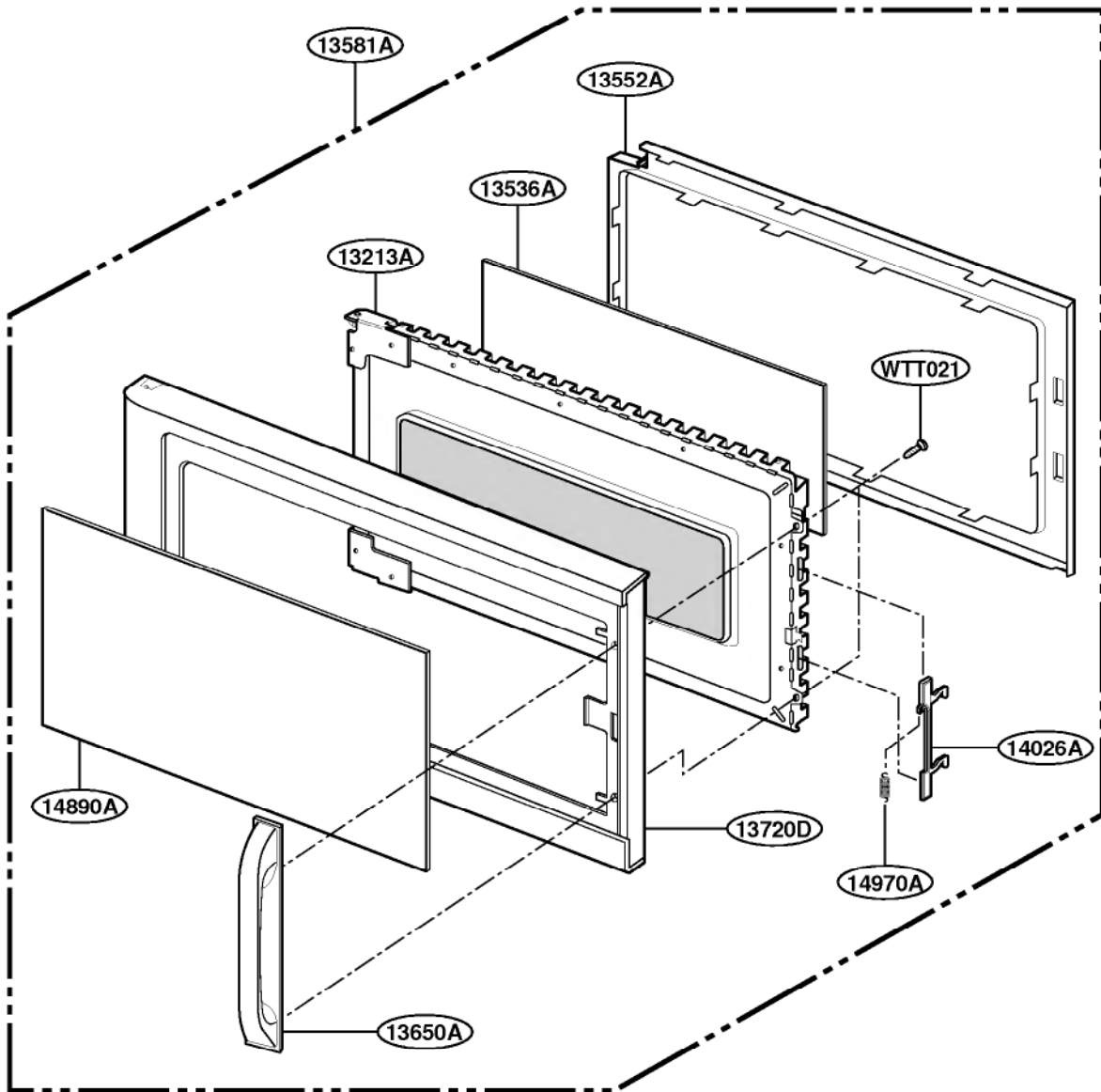

# CONTROLLER PARTS

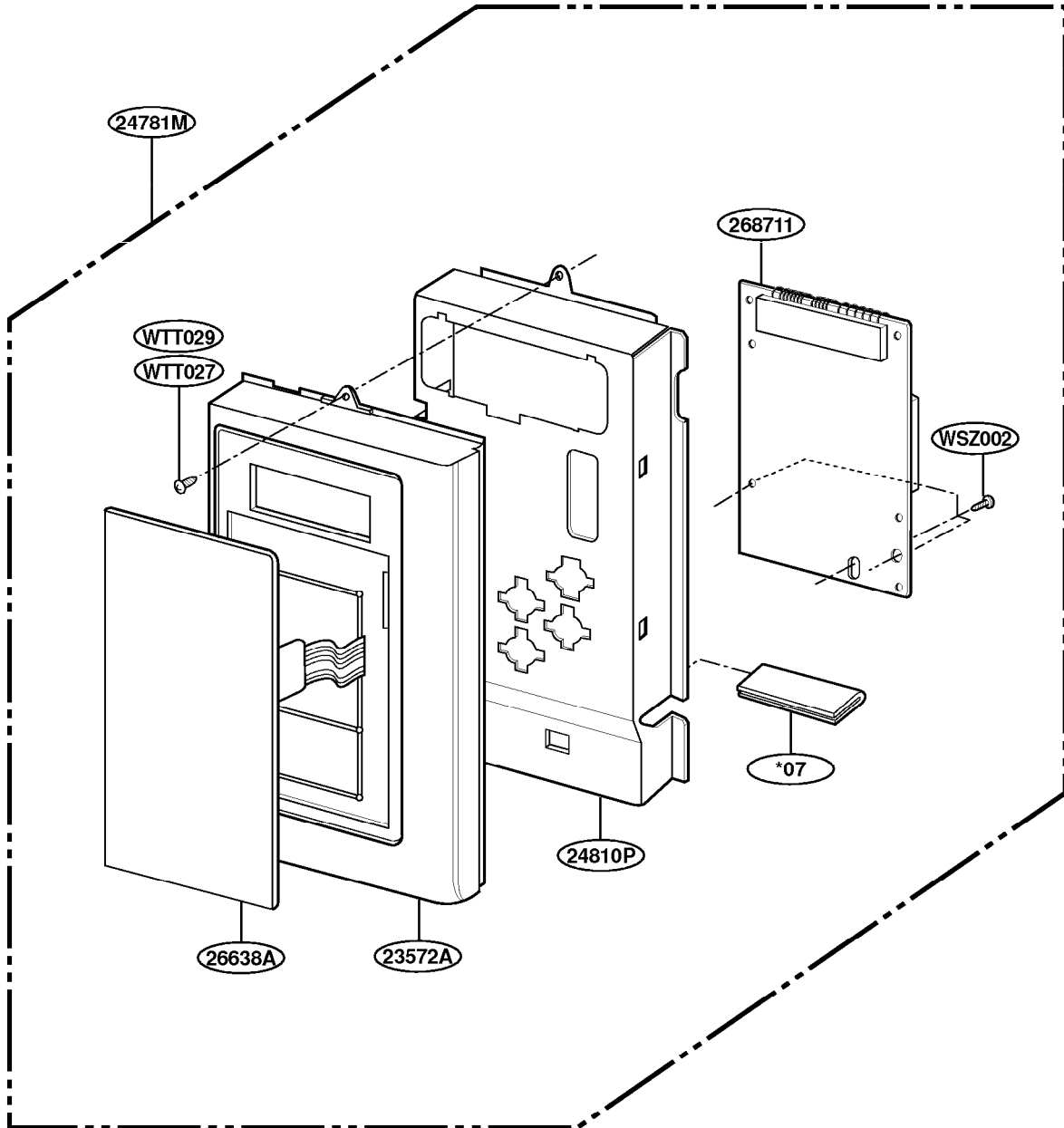

# OVEN CAVITY PARTS

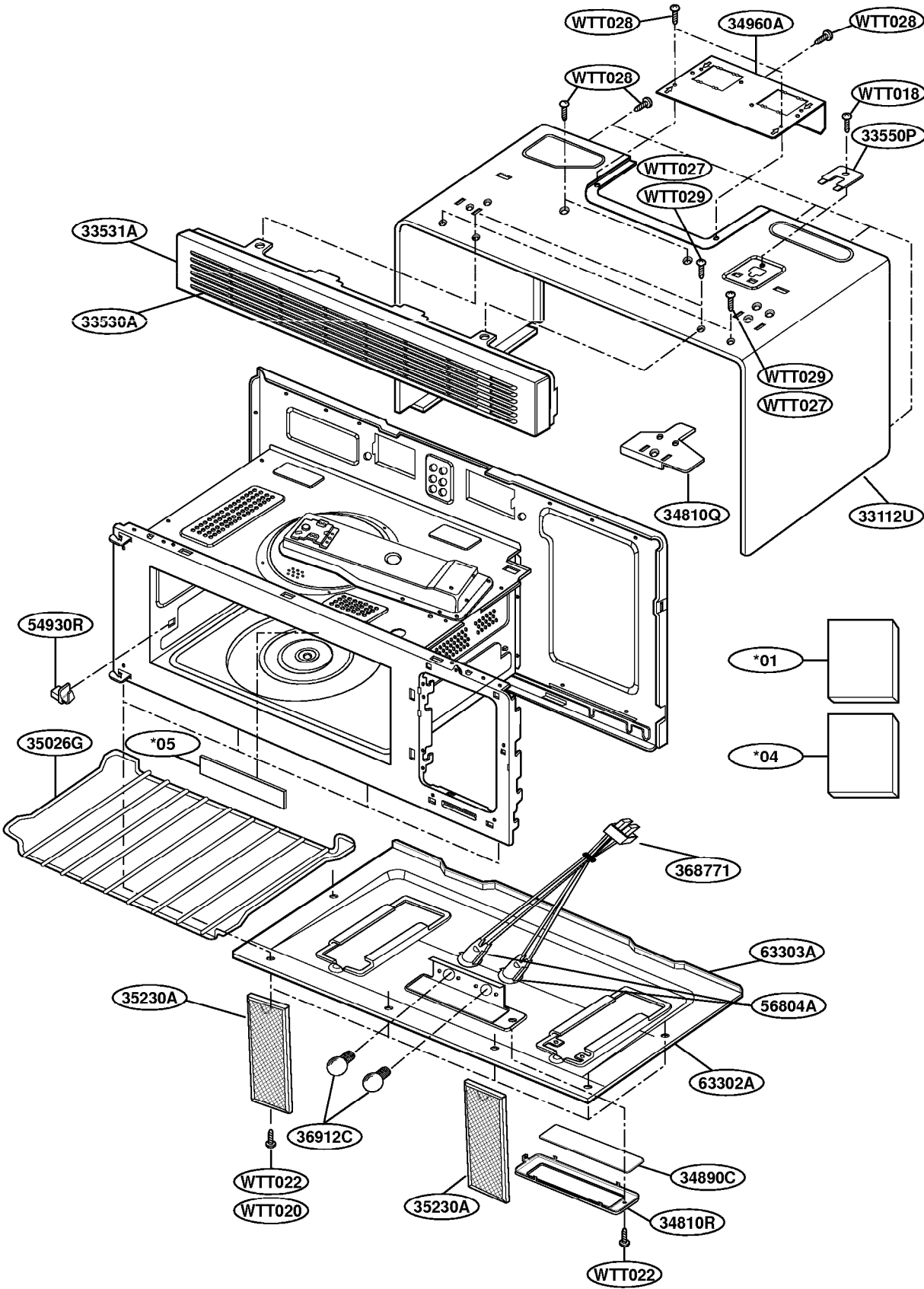

# LATCH BOARD PARTS

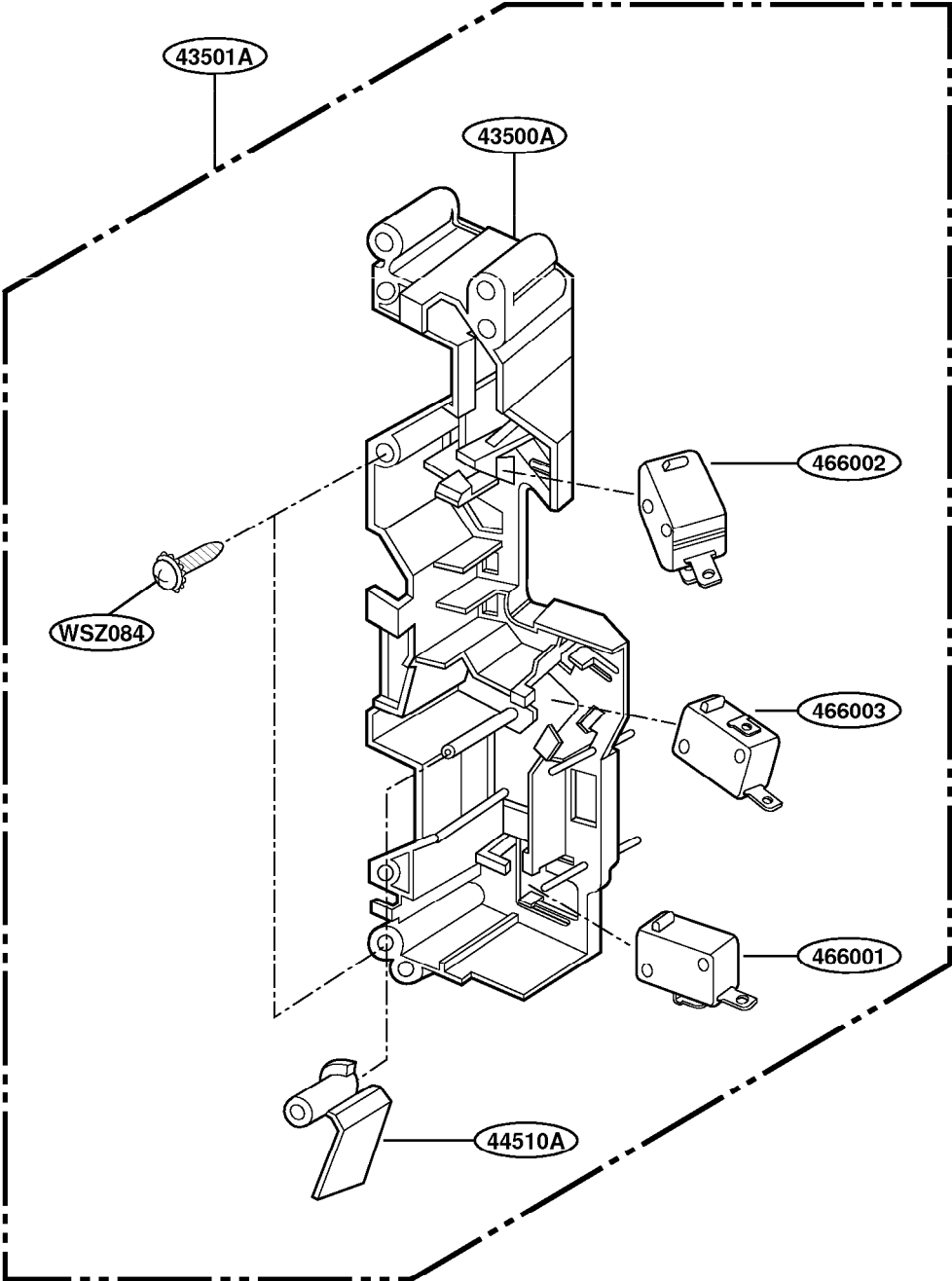

# INTERIOR PARTS (I)

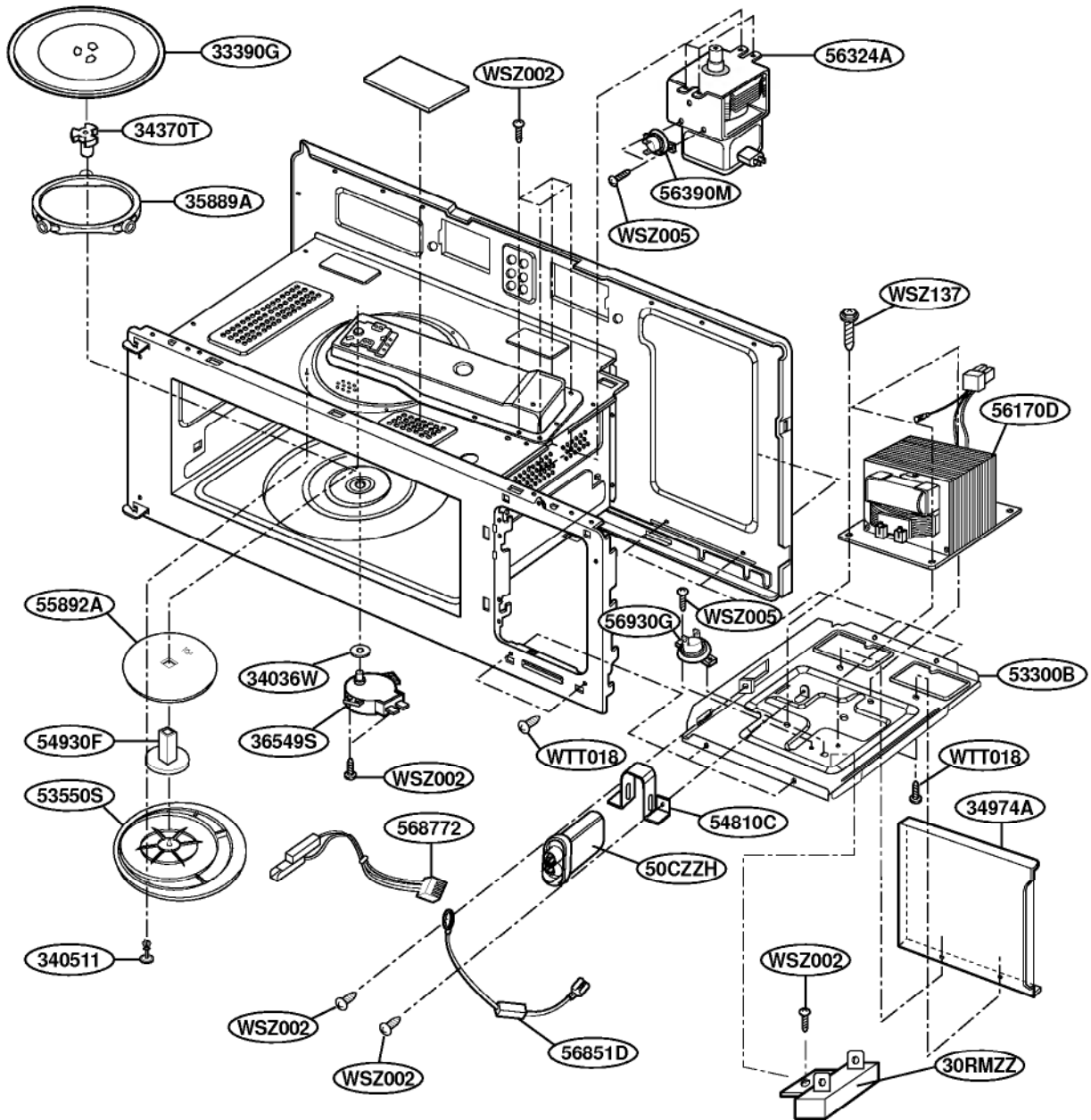

# INTERIOR PARTS (II)

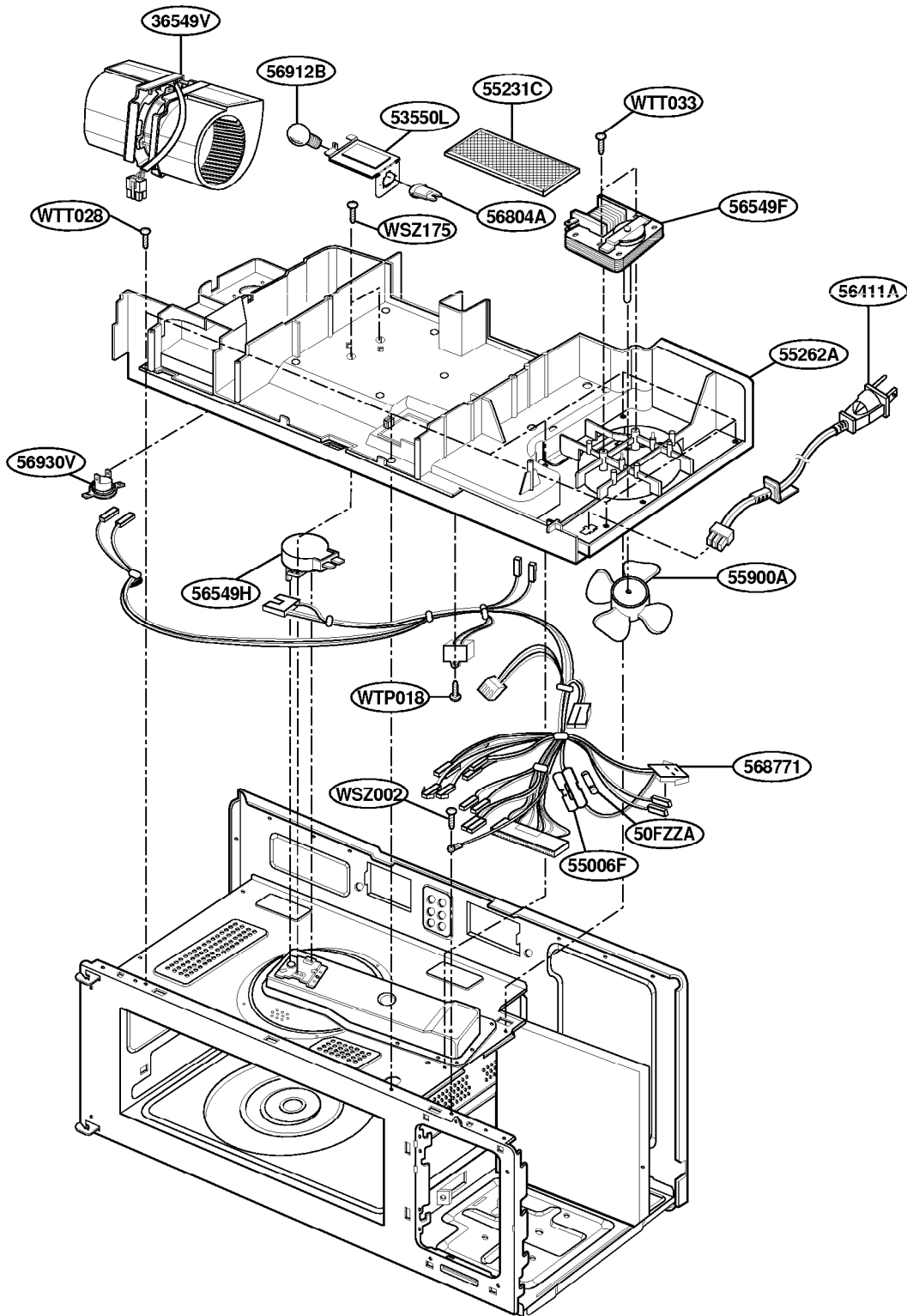

# INSTALLATION PARTS

