

EUREKA

Home Cleaning System Vacuum Cleaner

Household Type

Owner's Guide 6900 Series

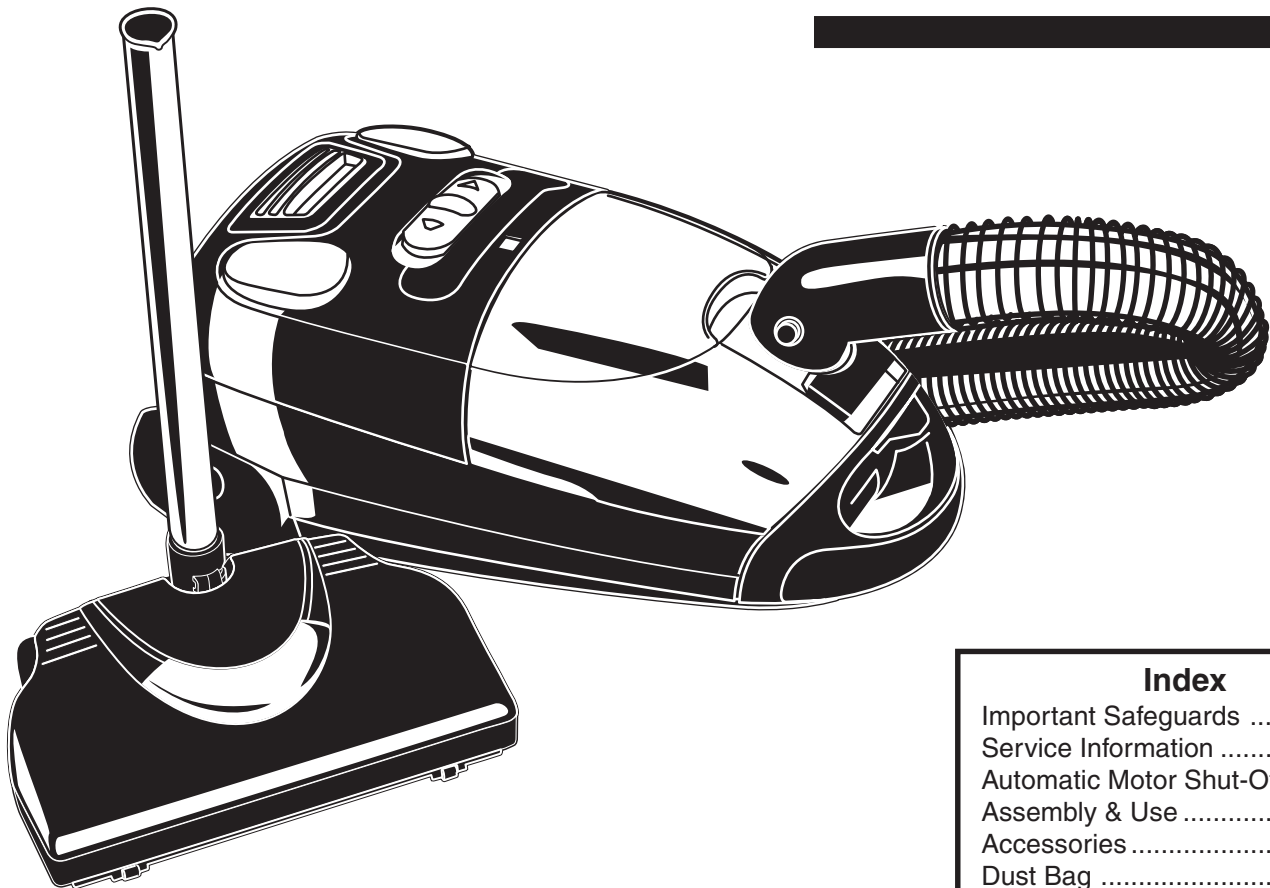

Index

| | |
|--------------------------------|-------|
| Important Safeguards | 2 |
| Service Information | 4 |
| Automatic Motor Shut-Off | 4 |
| Assembly & Use | 5-7 |
| Accessories | 8 |
| Dust Bag | 9 |
| Filters | 10 |
| Brush Roll | 11 |
| Brush Roll Belt | 11-12 |
| Light Bulb | 11-12 |
| Customer Order Form | 13-14 |
| Warranty | 15 |

IMPORTANT SAFEGUARDS

When using an electrical appliance, basic precautions should always be followed, including the following:

READ ALL INSTRUCTIONS BEFORE USING THIS VACUUM CLEANER.

WARNING

To reduce the risk of fire, electric shock, or injury:

- Do not use outdoors or on wet surfaces.
- **Do not leave vacuum cleaner when plugged in.** Turn off the switch and unplug the electrical cord when not in use and before servicing.
- Do not allow to be used as a toy. Close attention is necessary when used by or near children.
- Use only as described in this manual. Use only manufacturer's recommended attachments.
- Do not use with damaged cord or plug. If vacuum cleaner is not working as it should, has been dropped, damaged, left outdoors, or dropped into water, return it to a service center before using.
- Do not pull or carry by cord, use cord as a handle, close a door on cord, or pull cord around sharp edges or corners. Do not run vacuum cleaner over cord. Keep cord away from heated surfaces.
- Hold plug when rewinding onto cord reel. Do not allow plug to whip when rewinding.
- Do not use extension cords or outlets with inadequate current carrying capacity.
- Turn off all controls before unplugging.
- Always turn off this appliance before connecting or disconnecting either hose or motorized nozzle.
- Do not unplug by pulling on cord. To unplug, grasp the plug, not the cord.
- The hose contains electrical wires. Do not use if damaged, cut or punctured. Avoid picking up sharp objects.
- Do not handle plug or vacuum cleaner with wet hands.
- Do not put any object into openings. Do not use with any opening blocked; keep free of dust, lint, hair, and anything that may reduce airflow.
- This vacuum cleaner creates suction and contains a revolving brush roll. Keep hair, loose clothing, fingers, and all parts of body away from openings and moving parts.
- Do not pick up anything that is burning or smoking, such as cigarettes, matches, or hot ashes.
- Do not use without dust bag in place.
- Belt pulleys can become hot during normal use. To prevent burns, avoid touching the belt pulley when servicing the drive belt.
- Use extra care when cleaning on stairs.
- Do not use to pick up flammable or combustible liquids such as gasoline, or use in areas where they may be present.
- Store your cleaner in a cool, dry area.
- Keep your work area well lighted.
- Unplug electrical appliances before vacuuming them.

SAVE THESE INSTRUCTIONS

CONSEILS DE SÉCURITÉ

Lors de l'utilisation d'un appareil électrique, quelques précautions élémentaires doivent être observées, incluant les suivantes:

LISEZ TOUTES LES INSTRUCTIONS AVANT D'UTILISER VOTRE ASPIRATEUR.

AVERTISSEMENT

Pour réduire le risque de feu, de choc électrique, ou de blessure:

- Ne pas utiliser à l'extérieur ou sur des surfaces mouillées.
- **Fermez le commutateur et débranchez l'appareil lorsque vous ne l'utilisez pas ou avant le nettoyage ou l'entretien.**
- Ne permettez pas qu'il soit utilisé comme jouet. Une attention particulière est nécessaire lorsque utilisé par ou près d'un enfant.
- Suivez les recommandations d'utilisation de ce manuel. Utilisez uniquement les accessoires recommandés par le fabricant.
- Ne pas utiliser si le cordon ou la fiche sont endommagés. Si l'aspirateur ne fonctionne pas comme il le devrait, s'il a été échappé, s'il est endommagé, s'il a été laissé à l'extérieur ou échappé dans l'eau, retournez-le à un centre de service avant d'utiliser.
- Ne pas le tirer ou le transporter par le cordon, ne pas utiliser le cordon un guise de poignée. Ne pas fermer une porte sur le cordon ou tirer le cordon sur des coins ou bordures pointus. Ne pas circuler sur le cordon avec l'aspirateur. Tenir le cordon à distance des surfaces chauffantes.
- Tenir la fiche lorsque vous rebobinez le cordon électrique. Ne pas permettre que la fiche batte l'air.
- Ne pas utiliser des rallonges ou des prises qui n'ont pas de capacité suffisante pour transporter le courant.
- Éteindre toujours l'appareil avant de connecter ou de déconnecter le tuyau ou la lance motorisée.
- Fermer tous les contrôles avant de débrancher.
- Le tuyau contient des fils électriques et ne doit pas être utilisé s'il est abîmé, coupé ou percé. Éviter de ramasser les objets aigus.
- Ne pas débrancher en tirant sur le cordon. Pour débrancher, tenez la fiche et non le cordon.
- Ne pas manipuler la fiche ou l'aspirateur avec les mains mouillées.
- Ne pas rien insérer dans les ouvertures. Ne pas utiliser si des ouvertures sont bloquées; assurez-vous qu'elles soient dégagées de poussière, mousse, cheveux ou toute autre chose qui pourrait réduire le passage de l'air.
- Cet aspirateur crée de la succion et contient un rouleau-brosse tournant. Tenir les parties mobiles et les ouvertures loin des cheveux, du linge, des doigts et de toute partie du corps.
- Ne pas ramasser des objets qui brûlent ou fument comme les cigarettes, allumettes ou cendres chaudes.
- N'utilisez pas sans le sac de poussière en place.
- Les poulies du courroie peuvent devenir chaudes pendant l'utilisation normale. Pour prévenir des brûlures, évitez de touché la poulie du courroie lorsque vous réparez la courroie.
- Portez une attention particulière lorsque vous nettoyez les escaliers.
- Ne pas utiliser pour ramasser des liquides inflammables ou combustibles comme de l'essence. Ne pas utiliser dans les endroits où ces liquides pourraient être présents.
- Entrez votre aspirateur à l'intérieur dans un endroit propre et sec.
- Maintenez un bon éclairage à l'endroit où vous travaillez.
- Débrancher les appareils électrique avant de les balayer.

CONSERVEZ CES INSTRUCTIONS

To reduce the risk of electric shock, this appliance has a polarized plug (one blade is wider than the other). The plug will fit in a polarized outlet only one way. If the plug does not fit fully in the outlet, reverse the plug. If it still does not fit, contact a qualified electrician to install the proper outlet. Do not change the plug in any way.

Afin de réduire le risque de choc électrique, cet appareil est muni d'une fiche polarisée (une des lames est plus large). Cette fiche ne peut être insérée dans une prise polarisée que d'une seule façon. Si la fiche ne peut être insérée dans la prise, retourner la fiche. Si la fiche ne peut toujours pas être insérée dans la prise, faire installer une prise adéquate par un électricien qualifié. Ne pas modifier la fiche.

GENERAL INFORMATION

The bag may have come dislodged in shipping. Check the bag to insure proper seating before attempting to use the cleaner. Do not operate the cleaner without a dust bag or the filters. Damage may result to the motor (see Dust Bag and Filter).

The cleaner is designed to pick up dirt and dust particles. Avoid picking up hard or sharp objects with the cleaner to avoid bag breakage, hose clogging, or possible motor damage.

Service Information

The instructions in this booklet serve as a guide to routine maintenance. If additional service is required, telephone toll free:

USA: 1-800-282-2886
Mexico: 5670-6169
Canada: 1-800-282-2886

If you prefer, you can write to The Eureka Company, Service Division, 807 North Main Street, Bloomington, Illinois 61701, USA. In Canada write to The Eureka Company, 866 Langs Drive, Cambridge, Ontario N3H 2N7. Refer to The Eureka Limited Warranty for complete service information.





DO NOT OIL the motors (in the canister and the motorized nozzle) or the brush roll at any time. The bearings are permanently lubricated and sealed.

Rating Plate

The model, type and serial numbers are indicated on the rating plate located on the underneath side of the cleaner. For prompt and complete service information, always refer to these numbers when inquiring about service.

Model No. & Type _____

Serial No. _____

| | | | |
|--|---|---|----------------------------|
| MADE IN SWEDEN | | THE EUREKA COMPANY BLOOMINGTON, IL 61701 SERVICE INFORMATION: 1-800-282-2886 | |
| MODEL | TYPE | SERIAL NO. | |
| HOUSEHOLD TYPE  | TYPE MANAGER  | 120 V 60 HZ | AMPS 12.0 |

Automatic Motor Shut-Off

To protect from overheating, this vacuum cleaner is equipped with a thermostat which automatically shuts off the motor if it overheats. Should this happen:

- 1. Turn off the switch and unplug** the cleaner because the thermostat will allow the cleaner to automatically start running again when the motor cools (approximately 30 minutes);
- 2. Check the hose, bag, and filters** as a clogged hose, full bag, or dirty filters could cause the motor to overheat; and
- 3. Call a Eureka Service Station** if the cleaner will not operate after cooling for approximately 30 minutes.

ASSEMBLY ITEMS

NOTE: Unpack and identify all parts. Fully assemble before using.

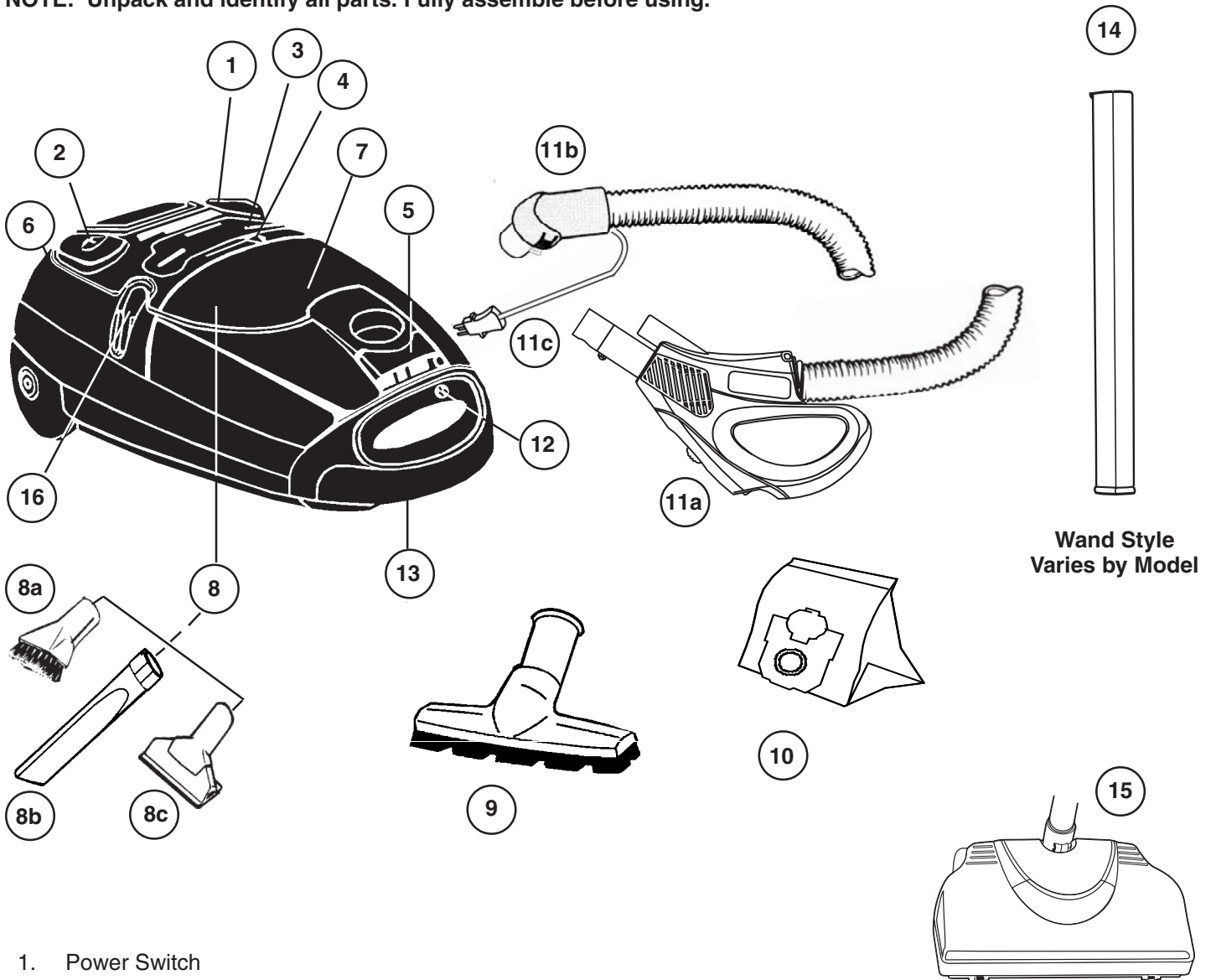

Wand Style
Varies by Model

Powerhead Style
Varies by Model

1. Power Switch
2. Cordaway Cord Reel
3. Variable Speed Control (on some models)
4. Bag Change Indicator
5. Bag Cover Latch
6. HEPA Filter
7. Tool-Pak Cover Latch
8. Tool-Pak Storage
 - a) Dusting Brush
 - b) Crevice Tool
 - c) Upholstery Nozzle
9. Floor Brush
10. Disposable Dust Bags
11. Hose has Power-Touch Handle with remote controls (11a) and coupling (11b) with plug (11c). See instructions on pages 6 and 7.
12. Hose Plug Connection
13. Canister Handle
14. Wands (2)
15. Motorized Nozzle
16. Parking slot for bare floor nozzle. There is an additional parking slot located on the bottom of the canister.

Always carry the vacuum by the handle when cleaning steps, etc.

How to Assemble and Use

POWER-TOUCH® Handle

Remote ON/OFF Selector for bare floor or carpet

*Off – push down on front

Bare Floor – push down on back

*Power ON/OFF can be controlled on some models from the POWER-TOUCH handle switch or canister ON/OFF switch. Other models can only use the canister switch.

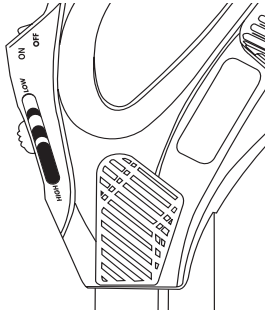

Vacuum Control

Cleaning suction is reduced by pushing lever to LOW position. Place lever at HIGH position to increase suction for carpet cleaning.

Available on models without Remote Speed Control.

1. Snap interlocking wands together.
2. Push assembled wands into power nozzle.
3. Place Power-Touch hose handle into wands until plug connects and button locks.
4. Insert hose coupling into top of canister and push hose power cord into receptacle located near the canister handle.
5. Pull on electrical cord and push plug into outlet. To rewind, step on Cordaway cord reel button, hold and guide plug while it rewinds.
6. Step on handle release to release handle; pull back to comfortable work position.
7. Push On/Off canister switch.
(A thermostat automatically shuts off the motor if it overheats, see Automatic Motor Shut-Off.)
8. Bare floor or carpet cleaning selection on remote control, only.

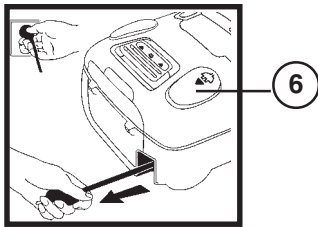

NOTE: Optional remote controls on the hose handle operate only if the canister switch is on.

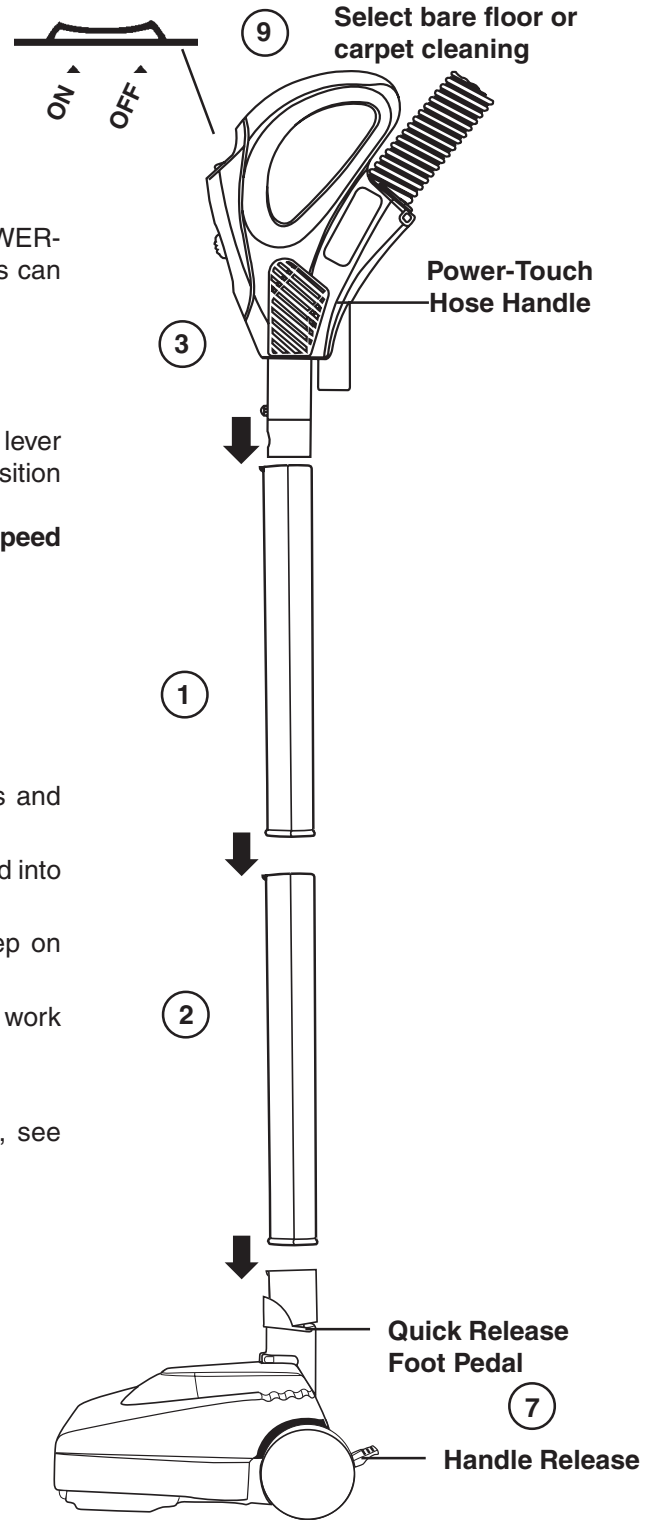
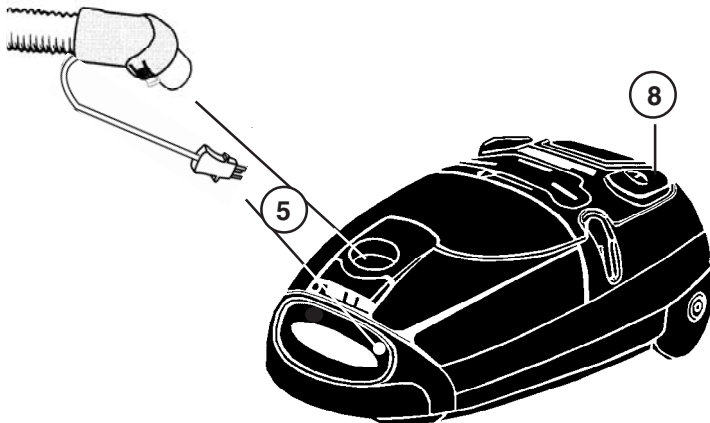

The **Quick Release** foot pedal allows the user to easily remove the motorized power nozzle for above the floor cleaning.
To disconnect power nozzle, step down on rear of the quick release foot pedal and pull up on wands.

How to Assemble and Use

POWER-TOUCH® Handle

Remote ON/OFF Selector for bare floor or carpet

Carpet – push down on front

***Off** – middle

Bare Floor – push down on back

*Power ON/OFF can be controlled on some models from the POWER-TOUCH handle switch or canister ON/OFF switch. Other models can only use the canister switch.

Remote Speed Control (optional)

Slide to reduce or increase power as needed.

Vacuum Control

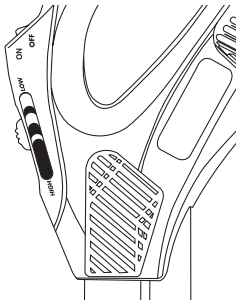

Cleaning suction is reduced by pushing lever to LOW position. Place lever at HIGH position to increase suction for carpet cleaning.

Available on models without Remote Speed Control.

1. Push interlocking wands together.
 2. Push assembled wands into power nozzle.
 3. Place Power-Touch hose handle into wands until plug connects and button locks.
 4. Insert hose coupling into top of canister.
 5. Push hose power cord into receptacle located near the canister handle.
 6. Pull on electrical cord and push plug into outlet. To rewind, step on Cordaway cord reel button, hold and guide plug while it rewinds.
 7. Step on handle release to release handle; pull back to comfortable work position.
 8. Push On/Off canister switch.
- (A thermostat automatically shuts off the motor if it overheats, see Automatic Motor Shut-Off,)
9. Bare floor or carpet cleaning selection on remote control, only.
 10. Variable Speed Control on the canister slides to increase or decrease power as needed.

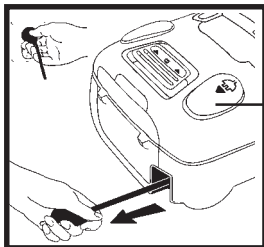

NOTE: Optional remote controls on the hose handle operate only if the canister switch is on.

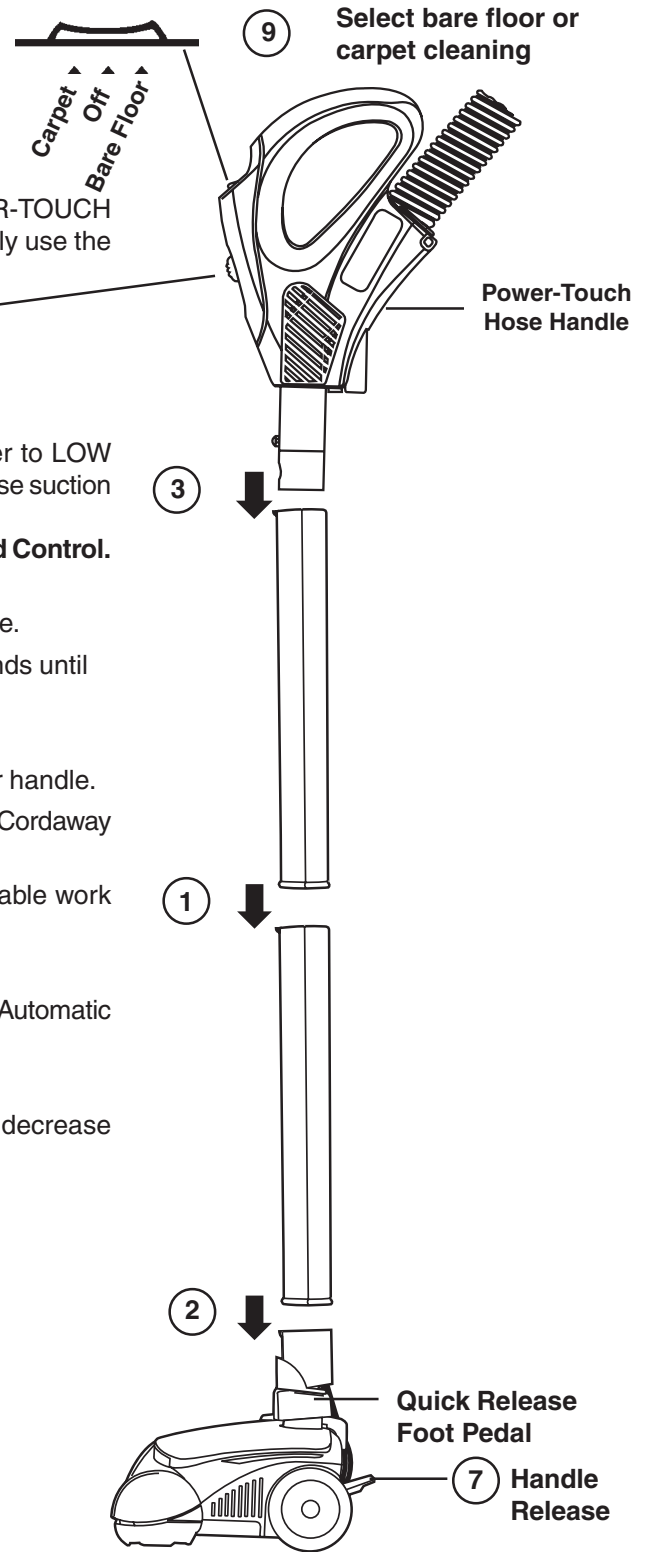
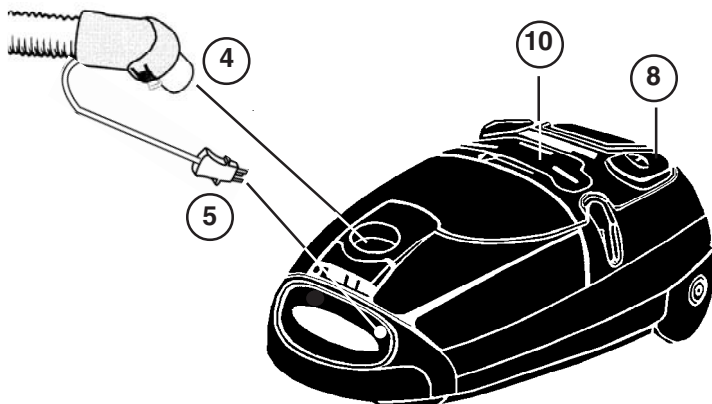

The **Quick Release** foot pedal allows the user to easily remove the motorized power nozzle for above the floor cleaning.

To disconnect power nozzle, step down on the rear of the quick release foot pedal and pull up on wands.

Tools

11. Lift the tool storage lid to open. The tools store under the cover. To use cleaning tools, attach them directly to end of hose or use the button-lock wand. Twist the round end of tool onto hose or wand until secure.
- a. **Dusting brush.** For furniture, blinds, books, lamp shades, shelves.
 - b. **Crevice tool.** For corners, baseboards, between cushions, sliding door tracks.
 - c. **Upholstery nozzle.** For curtains, draperies, cushions, fabrics.
 - d. **Floor brush.** (On some models.) For paneled walls, ceilings, beams, bare floor surfaces.

11

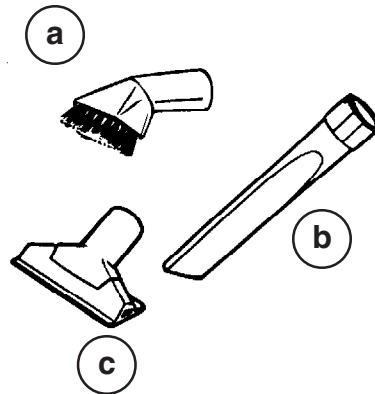
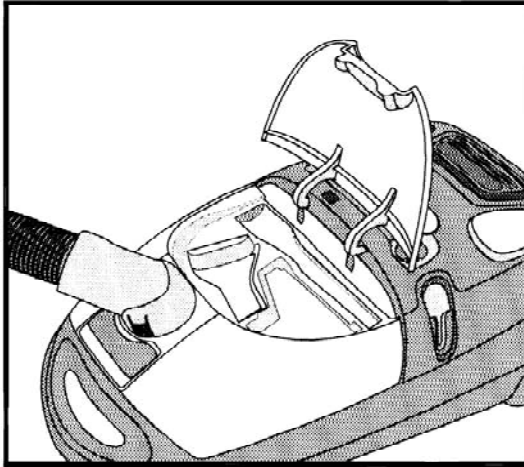

a

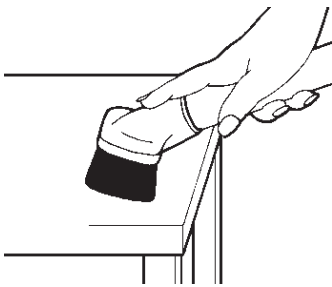

b

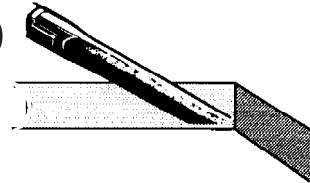

c

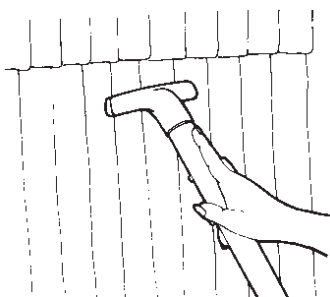

d

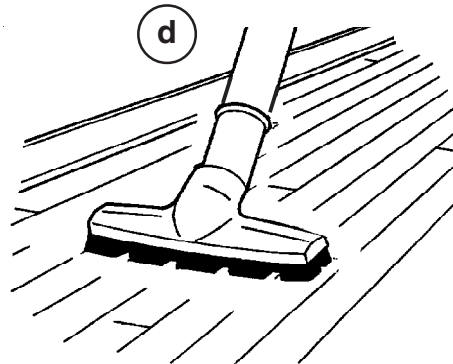

HOW TO MAINTAIN

The paper bag and filters play a very important role in the efficiency of the vacuum cleaner. The purpose of the paper bag is to trap dirt and at the same time the paper must be porous enough to allow air to pass through. If the paper bag or filters become clogged, no air can pass through the cleaner and no cleaning takes place regardless of how powerful the unit. To keep the cleaner operating at maximum efficiency, change the dust bag frequently and clean the filters as necessary.

Some fine particles can restrict airflow very quickly and will decrease performance even before the bag appears to be full. When vacuuming carpet fresheners or cleaners, plaster dust, or similar fine substances, clean the bag and filters more often.

Bag Change Indicator

The bag change indicator bar fills as the airflow through the bag decreases. Certain types of fine particles like powder, plaster dust, or carpet fibers can restrict airflow very quickly and will decrease performance even before the bag appears to be full. When the warning appears, change the disposable dust bag to restore maximum performance. If a clean dust bag does not restore maximum performance, clean the filters and check the hose and wands for obstructions.

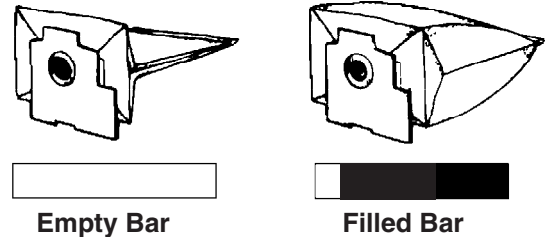

HOW TO CHANGE DISPOSABLE DUST BAG

NOTE: Turn off the power switch and disconnect electrical cord from wall socket before changing dust bag. Never use the cleaner without a dust bag or filters.

To remove used dust bag:

1. Unplug the hose plug to open the lid of bag compartment.
2. Push the bag's cardboard disc closed, grasp the cardboard collar and lift out the full bag.

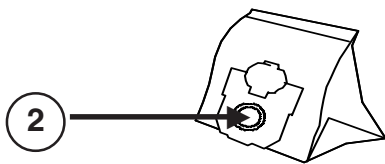
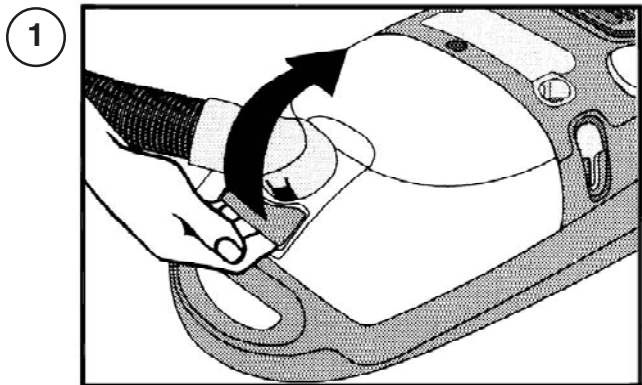

To install new dust bag:

3. Put in the new dust bag (part number 60284) by slotting the cardboard collar into the channel holder. The lid cannot be closed over a bag that is not fitted into place.

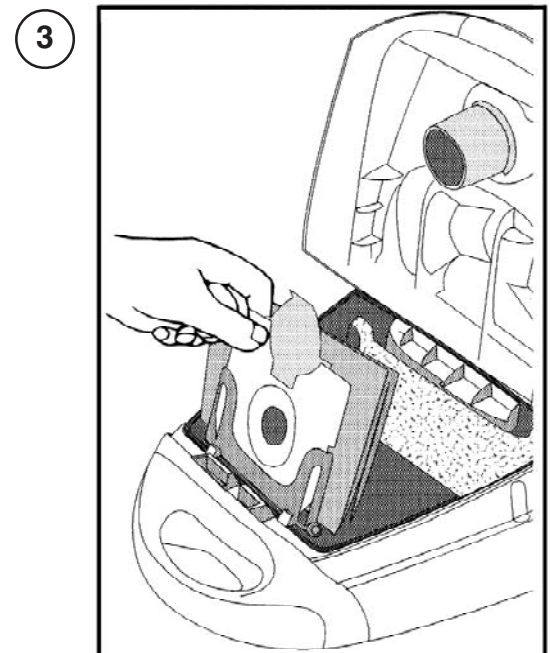

Filters

For maximum efficiency, be sure to maintain the motor filter and the final filter regularly.

Motor Filter

Inspect the motor filter with each disposable dust bag change.

The motor filter in the bag compartment should be cleaned when necessary or about twice a year.

- Open the cover and lift up on the filter.
- Shake out thoroughly.

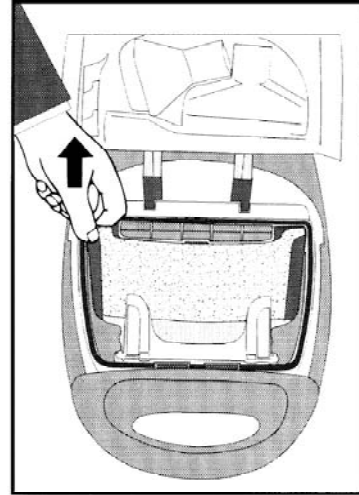

HEPA Filter/Micron Filter

Check the HEPA/Micron filter with each disposable dust bag change. Replace after every six bag changes or when obviously dirty.

1. To change HEPA/Micron filter, press exhaust grille to open the filter cover.
2. Remove filter cover by lifting up.
3. Pull out the used HEPA/Micron filter by using finger tab.
4. Put in new HEPA/Micron filter.
5. Replace filter cover.

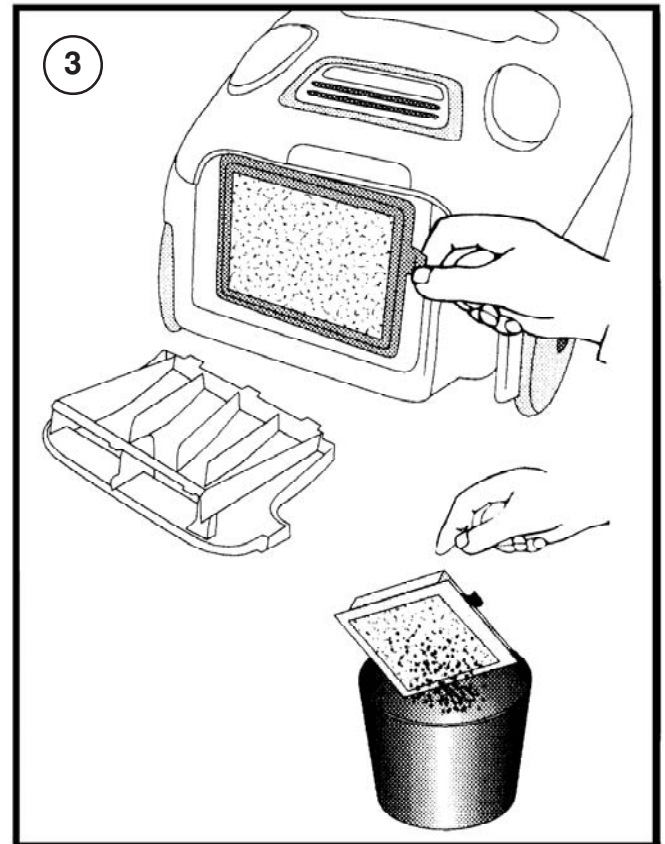
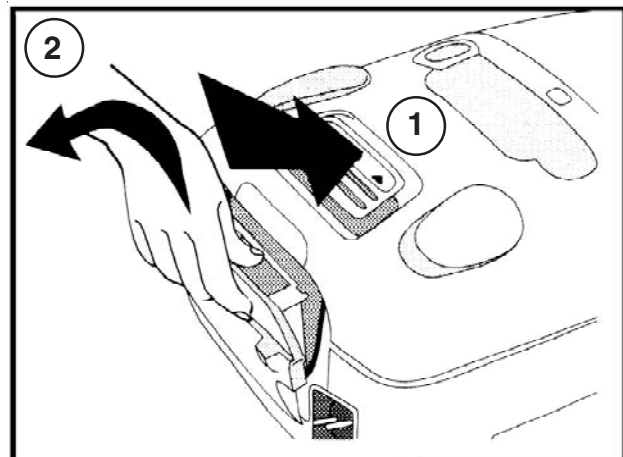

Brush Roll

The brush roll turns to sweep and comb the carpet nap. Keep the brush roll free from hair and threads so it will continue cleaning. When the bristles of the brush roll no longer touch a piece of cardboard held across the bottom plate, the brush roll is ineffective because the bristles no longer touch the carpet nap. To maintain the most effective cleaning, install a new brush roll.

Brush Roll Belt and Light Bulb

The brush roll belt on the motorized nozzle drives the brush roll to agitate, sweep, and comb the carpet nap. The belt should be checked regularly to be sure that it is in good condition. Replace the belt if it is stretching, cracking, or slipping. Cut away any hair or thread wound around the brush roll or belt pulley because the buildup could cause the belt to rotate unevenly.

How to Replace Worn Belt or Light Bulb (On Some Models)

NOTE: Turn off the switch and unplug the electrical cord before replacing belt or bulb. Pulleys can become hot during normal use. To prevent injury, avoid touching the pulleys when servicing the drive belt.

1. Remove six screws from bottom side. Turn unit over; pull up on hood to remove.

Replace light bulb, if necessary. Use GENUINE EUREKA replacement bulb, 59045.

Continue to step 2 to change belt. Skip to step 7 to replace hood.

2. Lift out brush roll and discard used belt.
3. Put new belt around brush roll pulley first; then the motor pulley.
4. Place left end cap into the base.
5. Pull right end of brush roll to stretch belt. Secure right end cap into base.
6. Rotate brush roll to seat belt.
7. Position hood; secure with screws.

Use GENUINE EUREKA replacement belt, 58065.

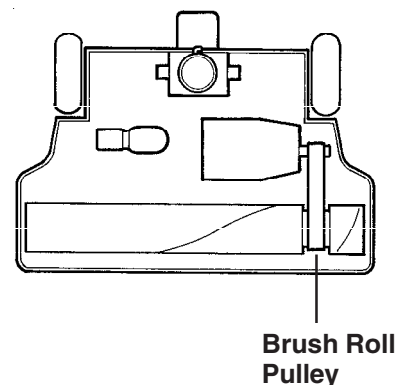
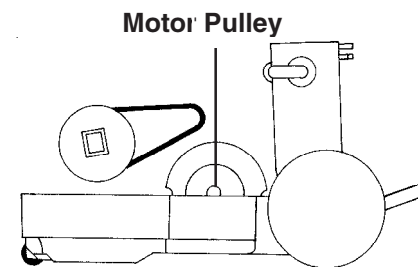
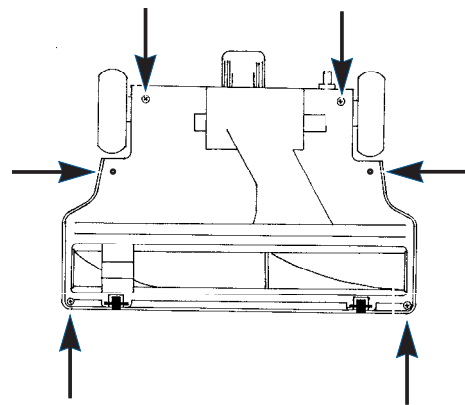

How to Replace Worn Belt or Light Bulb (On Some Models)

CAUTION:

Disconnect power cord and wands from electrical hose before replacing belt or bulb. Belt pulleys can become hot during normal use. To prevent burns, avoid touching the belt pulley when servicing the drive belt.

To replace the light bulb, remove the screws marked A,B,C,D.

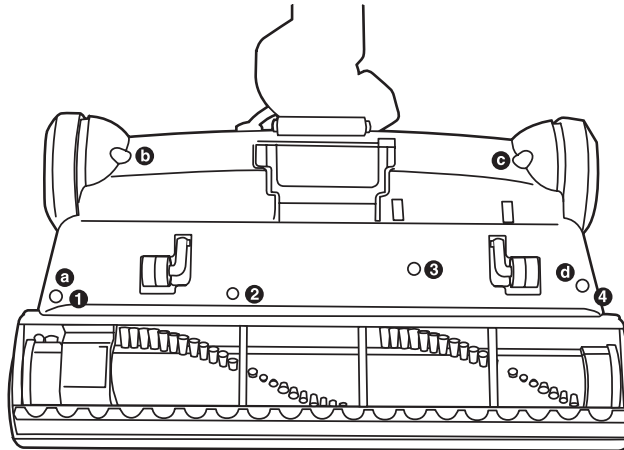

To replace the belt, remove the screws marked 1,2,3,4.

How to Replace Light Bulb

1. Flip power head over onto its top.
2. Remove the four screws marked by letters in the illustration above.
3. Flip power head back over.
4. Lift cover up to find light bulb inside.
5. Grasp light bulb and pull out of socket.
6. Push new light bulb into socket.
7. Reinstall cover on base and replace the four screws.

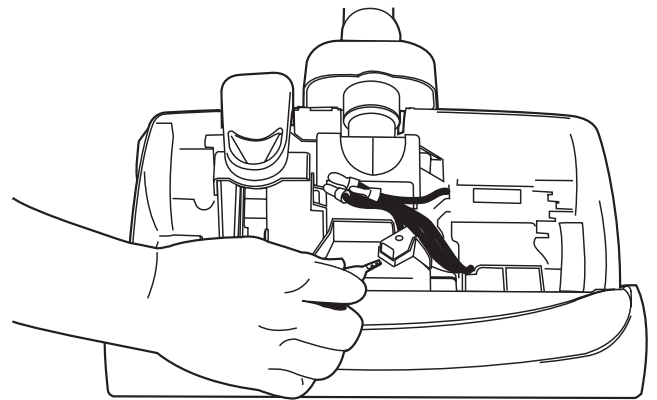

Use **GENUINE EUREKA** replacement bulb, 61682.

How to Replace Worn Belt

1. Flip power head over onto its top.
2. Remove the four screws marked by numbers in the illustration above.
3. Lift base plate up to find belt and brush roll inside.
4. Lift out brush roll and remove old belt.
5. Place new belt around brush roll pulley.
6. Place other end of belt around brush roll.
7. Replace brush roll into base.
6. Reinstall cover on base and replace the four screws.

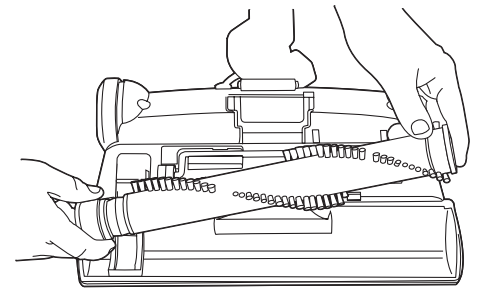

4

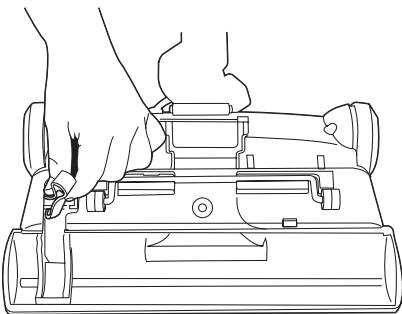

5

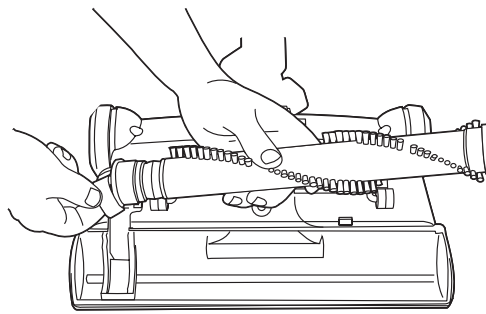

6

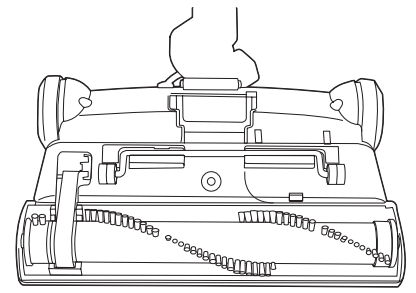

7

Use **GENUINE EUREKA** replacement belt, 52201B.

THE EUREKA LIMITED WARRANTY

What This Warranty Covers

Your Eureka cleaner is warranted to be free from all defects in material and workmanship in normal household use for a period of one year. The warranty is granted only to the original purchaser and members of his or her immediate household. The warranty is subject to the following provisions.

What This Warranty Does Not Cover

- Parts of the cleaner that require replacement under normal use, such as disposable dust bags, filters, drive belts, light bulbs, brush roll bristles, impellers and cleaning.
- Damages or malfunctions caused by negligence, abuse, or use not in accordance with the Owner's Guide.
- Defects or damages caused by unauthorized service or the use of other than Genuine Eureka parts.

What The Eureka Company Will Do

The Eureka Company will, at its option, repair or replace a defective cleaner or cleaner part that is covered by this warranty. As a matter of warranty policy, the Eureka Company will not refund the consumer's purchase price.

Warranty Registration

Please fill out and return the warranty registration card accompanying your cleaner.

Obtaining Warranty Service

To obtain warranty service you must return the defective cleaner or cleaner part along with proof of purchase to any Eureka Authorized Warranty Station. You will find the nearest location in the Yellow Pages, under "Vacuum Cleaners—Service and Repair." Be certain that the Warranty Station is "Eureka Authorized."

For the location of the nearest Eureka Authorized Warranty Station or for service information, telephone toll free:

USA: 1-800-282-2886
Mexico: 5670-6169
Canada: 1-800-282-2886

If you prefer, you can write to The Eureka Company, Service Division, 807 North Main Street, Bloomington, Illinois 61701, USA. In Canada write to The Eureka Company, 866 Lings Drive, Cambridge, Ontario N3H 2N7.

If it is necessary to ship the cleaner outside your community to obtain warranty repair, you must pay the shipping charges to the Eureka Authorized Warranty Station. Return shipping charges will be paid by the Warranty Station. When returning parts for repair, please include the model, type, and serial number from the data plate on the cleaner.

Further Limitations and Exclusions

Any warranty that may be implied in connection with your purchase or use of the cleaner, including any warranty of Merchantability or any warranty for Fitness For A Particular Purpose is limited to the duration of this warranty. Some states do not allow limitations on how long an implied warranty lasts, so the above limitations may not apply to you.

Your relief for the breach of this warranty is limited to the relief expressly provided above. In no event shall Eureka be liable for any consequential or incidental damages you may incur in connection with your purchase or use of the cleaner. Some states do not allow the exclusion or limitation of incidental or consequential damages, so the above limitation or exclusion may not apply to you.

This warranty gives you specific legal rights. You may also have other rights which vary by state.



Questions & Answers about Genuine Eureka Products

Q Why should I use only Genuine Eureka paper bags, belts, and parts in my Eureka vacuum cleaner?

A Using Genuine Eureka Products, which are made to our exacting specifications and engineered with emphasis on quality, performance, and customer satisfaction, ensures the long life and cleaning efficiency of your vacuum cleaner. Overall, this saves you money and helps to keep your home clean.

Q How can I be sure I am using only genuine Eureka products in my vacuum cleaner?

A Typically, packaged products and paper bags can be identified by a "Genuine Eureka Product" symbol (see illustration above). For further identification assistance, you may call our toll-free number, 1-800-282-2886, for the location of a nearby Eureka Authorized Warranty Station.

Q Are there any differences between "made to fit" or "imitation" and Genuine Eureka paper bags, belts, and parts?

A Yes, there are some very important differences in materials, quality, and reliability. Many customers have mistakenly purchased "imitation" paper bags and parts while thinking they purchased genuine. Unfortunately, many of these customers discovered the differences after they experienced related difficulties.

For Genuine Eureka Value, Accept No Imitations!

THE EUREKA COMPANY

Bloomington, Illinois 61701

