

This Owner's Manual is provided and hosted by Appliance Factory Parts.

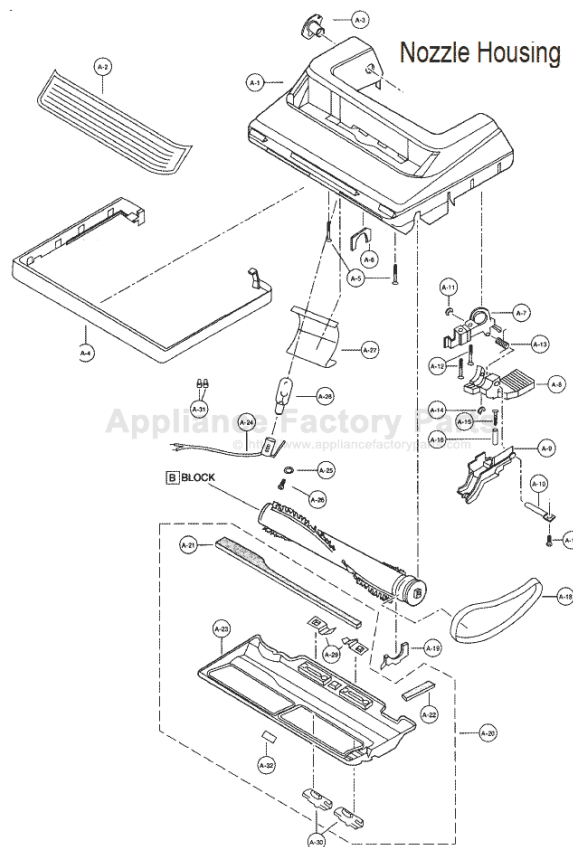

PANASONIC V5237 Owner's Manual

[Shop genuine replacement parts for PANASONIC
V5237](#)



[Find Your PANASONIC Vacuum Cleaner Parts - Select From 605 Models](#)

----- Manual continues below -----

Models: MC-V5207, MC-V5217, MC-V5227, MC-V5237, MC-V5238, MC-V5247, MC-V5248

Nozzle Housing

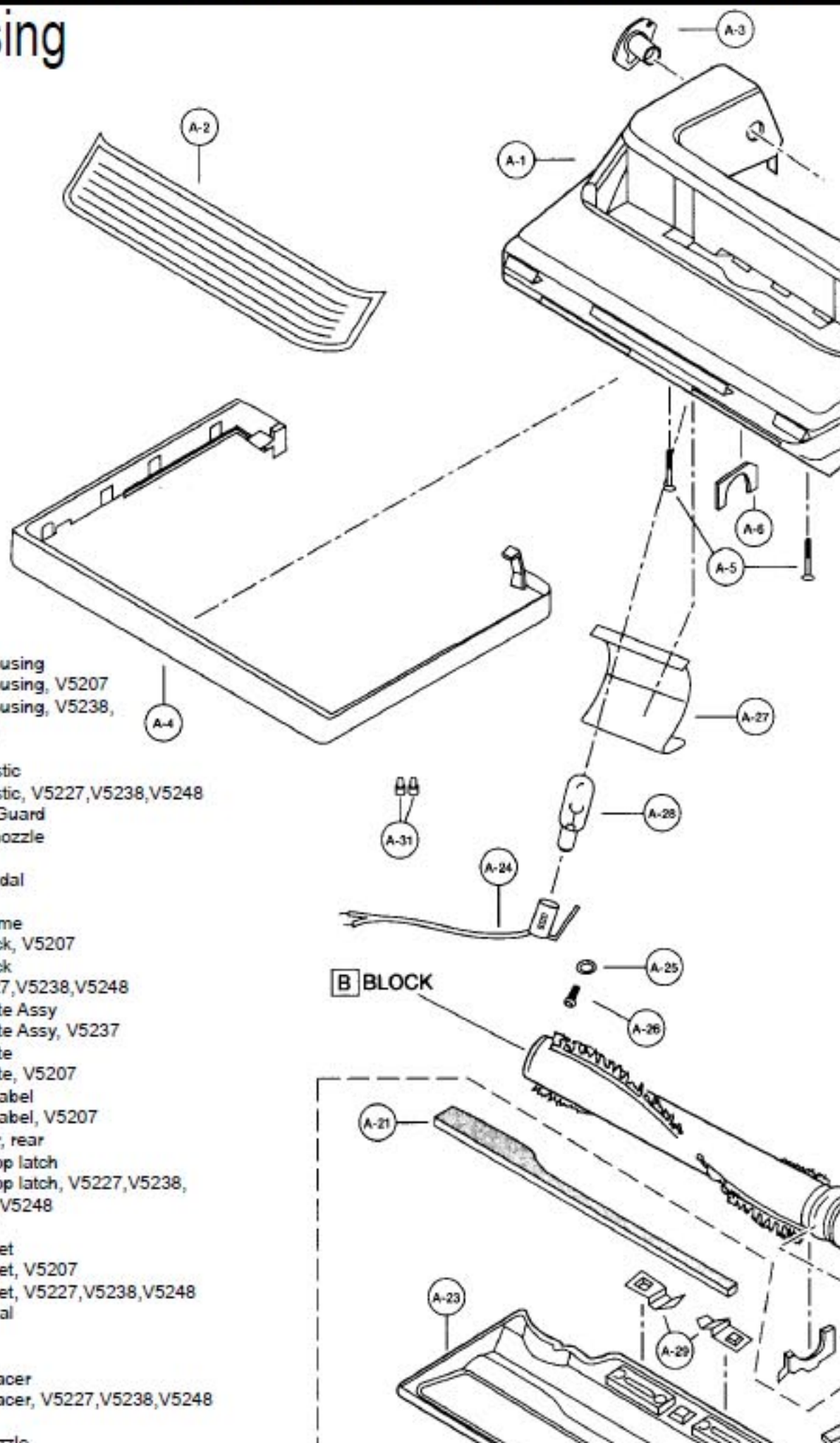

- | | | |
|---------|---------------|--|
| 1..... | P-8938..... | Nozzle Housing |
| 1..... | P-1104..... | Nozzle Housing, V5207 |
| 1..... | P-10857..... | Nozzle Housing, V5238, V5248 |
| 2..... | P-2125..... | Window |
| 3..... | P-2500..... | Shaft, plastic |
| 3..... | P-10819..... | Shaft, plastic, V5227, V5238, V5248 |
| 4..... | P-9825..... | Furniture Guard |
| 5..... | P-81..... | Packing, nozzle |
| 6..... | P-000095..... | Frame |
| 7..... | P-000010..... | Spring, pedal |
| 8..... | P-4720..... | Pedal |
| 9..... | P-6140..... | Screw, frame |
| 10..... | P-280B..... | Belt, 2 pack, V5207 |
| 10..... | P-V270B..... | Belt, 2 pack |
| 10..... | P-00181..... | Belt, V5227, V5238, V5248 |
| 11..... | P-8939..... | Lower Plate Assy |
| 11..... | P-8439..... | Lower Plate Assy, V5237 |
| 12..... | P-8942..... | Lower Plate |
| 12..... | P-000133..... | Lower Plate, V5207 |
| 13..... | P-9826..... | Warning Label |
| 13..... | P-07000..... | Warning Label, V5207 |
| 14..... | P-1124..... | Belt Cover, rear |
| 15..... | P-704..... | Spring, stop latch |
| 15..... | P-9846..... | Spring, stop latch, V5227, V5238, V5247, V5248 |
| 16..... | P-2751..... | Latch |
| 17..... | P-0039..... | Bulb Socket |
| 17..... | P-9301..... | Bulb Socket, V5207 |
| 17..... | P-9367..... | Bulb Socket, V5227, V5238, V5248 |
| 18..... | P-00051..... | Shaft, pedal |
| 19..... | P-7411..... | Spacer |
| 20..... | P-4003..... | E-Clip |
| 21..... | P-9827..... | Screw, spacer |
| 21..... | P-10812..... | Screw, spacer, V5227, V5238, V5248 |
| 22..... | P-10109..... | Reflector |
| 23..... | P-683..... | Screw, nozzle |

PANASONIC

V

Models: MC-V5207, MC-V5217, MC-5227, MC-V5237, MC-V5238, MC-V5247, MC-V5248

1..... P-40906..... Dust Container, V5207, V5237	25..... P-27009..... Carbon Brush, V5207	46..... P-4104.....
1..... P-8826..... Dust Container, V5217	25..... P-9834..... Carbon Brush, V5217	47..... P-2420.....
1..... P-10917..... Dust Container, V5227	25..... P-8182..... Carbon Brush, V5227/37/38/47/48	48..... P-9835.....
1..... P-10859..... Dust Container, V5238	26..... P-0036..... Bracket	48..... P-6420.....
1..... P-10341..... Dust Container, V5247	27..... P-0037..... Screw, brush	49..... P-5500.....
1..... P-10862..... Dust Container, V5248	28..... P-9911..... Motor Support, rubber, rear	49..... P-8916.....
2..... P-8913..... On/Off Switch	28..... P-10338..... Motor Support, rubber, rear, V5227, V5238, V5248	50..... P-9836.....
3..... P-7301..... Screw, handle	29..... P-9931..... Noise Suppressor	50..... P-5300.....
4..... P-000625..... Suction Inlet	29..... P-99300..... Noise Suppressor, V5207	50..... P-5300.....
5..... P-8914..... Suction Inlet, V5237	29..... P-10878..... Noise Suppressor, V5227	51..... P-7670.....
5..... P-10860..... Suction Inlet, V5238	29..... N/A..... Noise Suppressor, V5238	52..... P-587.....
5..... P-8915..... Cover	30..... P-0950..... Motor Case, V5207	53..... P-4309.....
5..... P-8972..... Cover, V5217	30..... P-8943..... Motor Case, V5217	54..... P-9838.....
6..... P-66106..... Packing, dust cover	30..... P-10876..... Motor Case, V5227	54..... P-5400.....
6..... P-660106..... Packing, dust cover, V5227, V5238, V5248	30..... P-10861..... Motor Case, V5238, V5248	55..... P-9706.....
7..... P-3820..... Wire Cord	30..... P-10342..... Motor Case, V5247	55..... P-9806.....
7..... P-37020..... Wire Cord, V5217/47	31..... P-00117..... Packing, motor case, V5207	55..... P-1080.....
8..... P-8917..... Nozzle Hose	31..... P-10825..... Packing, motor case, V5227	55..... P-9706.....
8..... P-7549..... Nozzle Hose, V5217, V5247	31..... P-1906..... Packing, motor case, V5217, V5238, V5247, V5248	56..... P-115F.....
9..... P-30606..... Switch Cover	32..... P-4160..... Body Packing, left, V5207	56..... P-145M.....
9..... P-30406..... Switch Cover, V5207	33..... P-3905..... Body Packing, right, V5207	57..... P-0002.....
10..... P-73006..... Packing, switch cover	34..... P-1806..... Protector Supporter	58..... P-0002.....
10..... P-7306..... Packing, switch cover, V5207	35..... P-6096..... Protector	P-5360.....
11..... P-6140..... Screw, switch cover	36..... P-9832..... Spring, protector, green	P-1034.....
11..... P-6140..... Screw, switch cover, V5217, V5238, V5247	36..... P-10415..... Spring, protector, V5227	P-9837.....
12..... N/A..... Cord Stopper	37..... P-68006..... Case, protector, V5207	P-6088.....
12..... P-0698..... Cord Stopper, V5227, V5237, V5238, V5247, V5248	37..... P-6806..... Case, protector, V5217, V5227	P-6069.....
13..... P-6140..... Screw, cord stopper	38..... P-201..... Packing, rear cover	P-1080.....
14..... P-6140..... Screw, suction inlet, V5207	38..... P-10918..... Packing, rear cover, V5227	P-8180.....
15..... P-2117..... Nut, handle screw	39..... P-6140..... Screw, motor case, V5207	P-1078.....
16..... P-000623..... Wire Nut, V5207, V5238, V5247, V5248	39..... P-8172..... Screw, motor case, V5227, V5238, V5248	P-6010.....
17..... P-74009..... Stopper, wheel	40..... P-6406..... Dust Cover, V5207	P-0010.....
17..... P-74001..... Stopper, wheel, V5207	40..... P-8945..... Dust Cover, V5217	P-1034.....
18..... P-0114..... Wheel	40..... P-10879..... Dust Cover, V5227	P-1071.....
19..... P-6115..... Washer	40..... P-8944..... Dust Cover, V5237	
20..... P-16005..... Shaft, wheel	40..... N/A..... Dust Cover, V5238	P-8184.....
21..... P-3200..... Filter Supporter	40..... P-10344..... Dust Cover, V5247	P-1030.....
22..... P-9829..... Secondary Filter, electrostatic	40..... P-10864..... Dust Cover, V5248	P-8946.....
22..... P-9994..... Secondary Filter, HEPA, V5237, V5238, V5247, V5248	41..... P-9300..... Indicator Packing	P-1034.....
23..... P-0293..... Motor Support, rubber, front	42..... P-000147..... Indicator Cap	P-1086.....
24..... P-2908..... Motor Assy, V5207	43..... P-0400..... Indicator Spring	P-6140.....
24..... P-10877..... Motor Assy, V5227	43..... P-10400..... Indicator Spring, V5238, V5248	P-8972.....
24..... P-9833..... Motor Assy, V5217	44..... P-000149..... Indicator Lead	P-1068.....
24..... P-7552..... Motor Assy, V5237	45..... P-000150..... Indicator Body	P-1084.....
24..... P-10343..... Motor Assy, V5238, V5247, V5248	45..... P-98109..... Indicator Body, V5238, V5248	
	46..... P-000610..... Screw, indicator	

Agitator Assembly

