

This Owner's Manual is provided and hosted by [Appliance Factory Parts](#).



PANASONIC 9530 Owner's Manual

[Shop genuine replacement parts for PANASONIC 9530](#)

Attachments

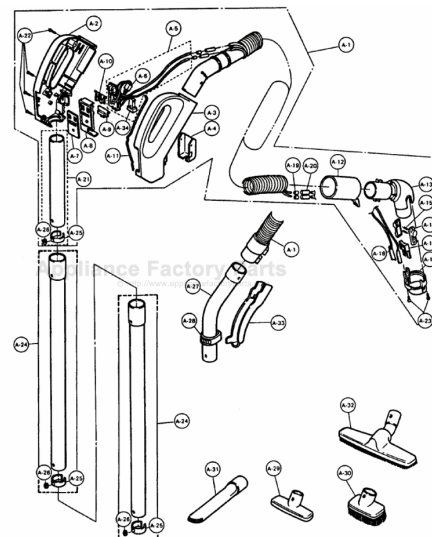

[Find Your PANASONIC Vacuum Cleaner Parts - Select From 605 Models](#)

----- Manual continues below -----

PANASONIC

Models: MC-9510, MC-9520, MC-9527, MC-9530, MC-9

Attachments

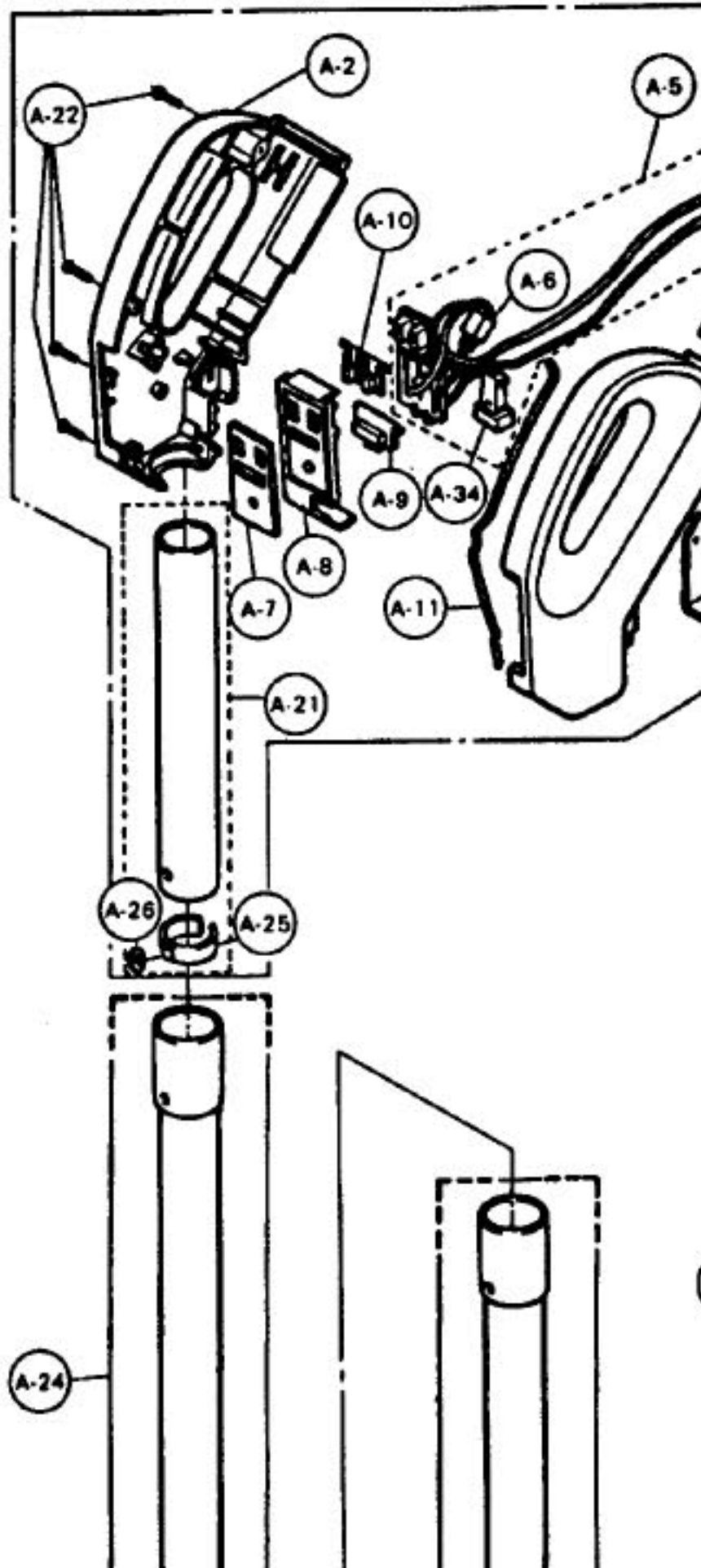

Body Unit

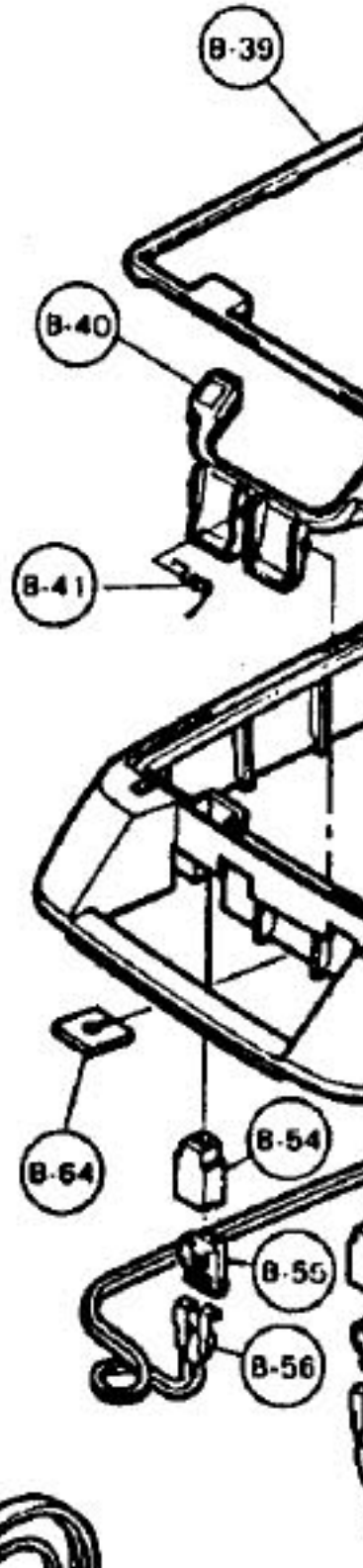
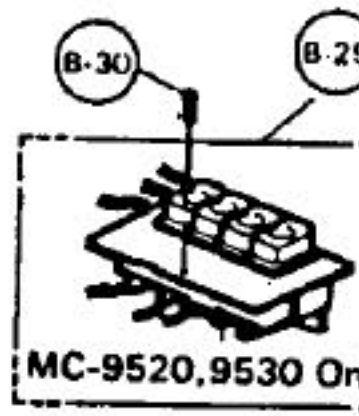
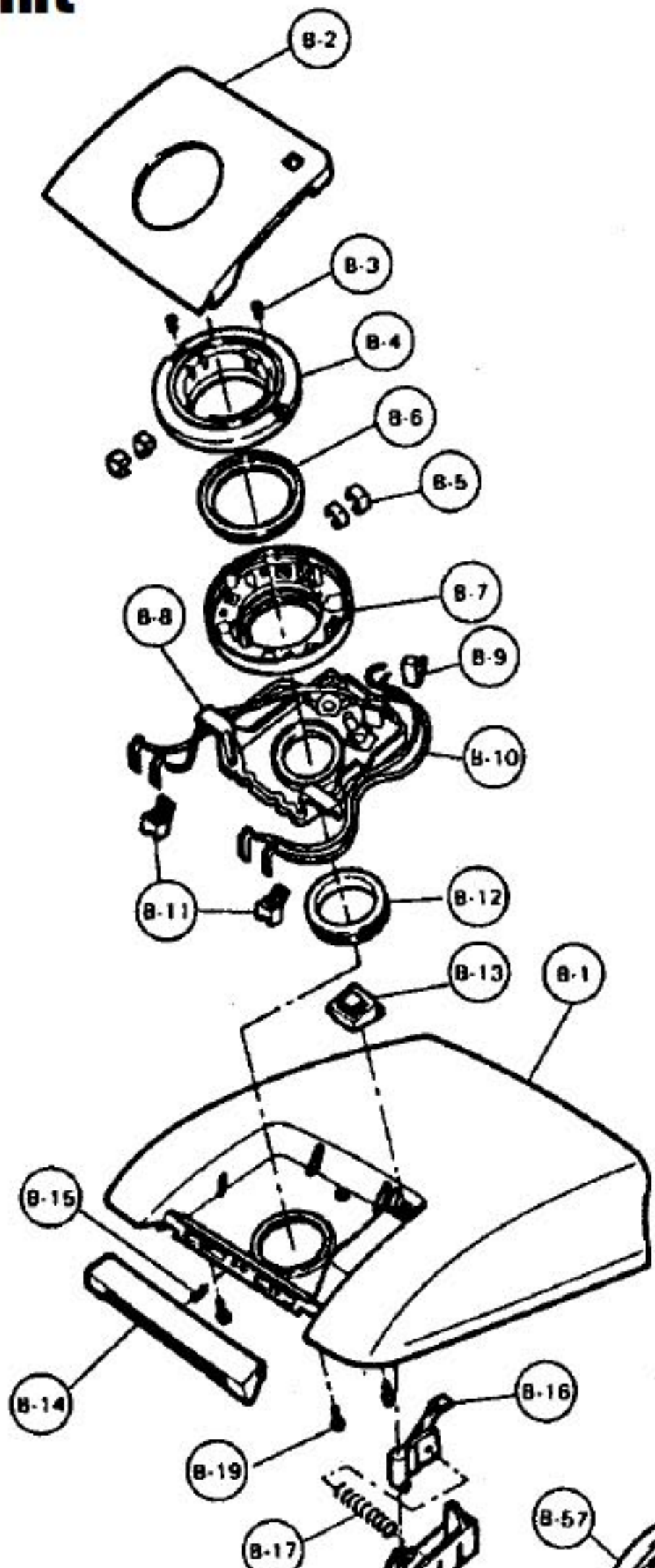

PANASONIC

Models: MC-9510, MC-9520, MC-9527, MC-9537, MC-

B1	P-6042	Dust Cover
B1	P-00024	Dust Cover, 9527, 9537
B2	P-255	Front Cover
B2	P-00025	Front Cover, 9527, 9537
B3	P-13143	Screw, connection upper
B4	P-6043	Connection Upper
B4	N/A	Connection Upper, 9527, 9537
B5	P-354	Terminal, connection upper
B6	P-644	Rubber, hose fitting
B7	P-174	Connection Lower
B7	P-00029	Connection Lower, 9527, 9537
B8	P-3941	Contact Base
B8	P-00030	Contact Base, 9527, 9537
B9	P-3242	Sub-Switch, on / off
B10 ..	P-9341	Terminal, w/ lead wire
B11 ..	P-454	Holder, terminal
B11 ..	P-00031	Holder, terminal, 9527
B12 ..	P-1940	Dust Bag Fitting, rubber
B13 ..	P-084	Window, 9510,9520,9527,9530 9537
	P-0841	Front Cover Lid, 9540
B14 ..	P-0142	Dust Cover Catch
B14 ..	P-00034	Dust Cover Catch, 9527, 9537
B15 ..	P-18311	Spring, dust cover catch
B15 ..	P-000313	Spring, dust cover catch, 9527
B16 ..	P-0341	Indicator
B17 ..	P-0441	Spring, indicator, 9510
B17 ..	P-0442	Spring, indicator
B18 ..	P-1740	Cover, vac guage
B18 ..	P-00037	Cover, vac guage, 9527, 9537
B19 ..	P-418	Screw, dust cover
B20 ..	P-7441	Tool Storage Cover
B20 ..	N/A	Tool Storage Cover, 9527, 9537
B21 ..	P-0242	Upper Body, 9510,9520,9530
B21 ..	P-00089	Upper Body, 9527, 9537

B31
B32
B32
B33
B33
B34
B35
B36
B37
B38
B39
B39
B40
B40
B41
B42
B42
B43
B44
B45
B46
B47
B47
B48
B49
B50
B51
B51
B52
B53
B53
B54
B54

Cord Reel Unit

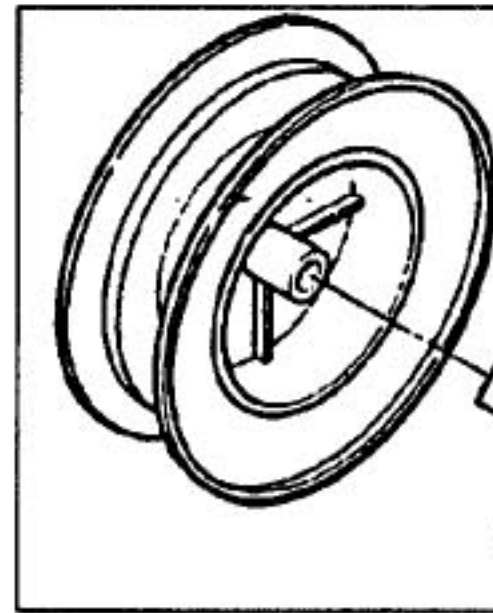

- C1 N/A Cord Reel Unit, 9510
- C1 P-9940 Cord Reel Unit, 9520,9530,9540
- C1 P-000334 Cord Reel Unit, 9527
- C1 P-00071 Cord Reel Unit, 9537
- C2 P-12399 Power Cord, w/ rail base, 9510
- C2 P-9842 Power Cord, w/ rail base, 9520,
9530,9540
- C2 P-000335 Power Cord, w/ rail base, 9527
- C2 P-00072 Power Cord, w/ rail base, 9537
- C3 P-9443 Brake Lever
- P-000336 Brake Spring, 9527
- C5 P-1941 Contact Base Unit, 9510
- C5 P-1942 Contact Base Unit
- C6 P-0443 Body Partition
- C7 P-416 Screw, C6,C5, 10 pack

Motor Unit

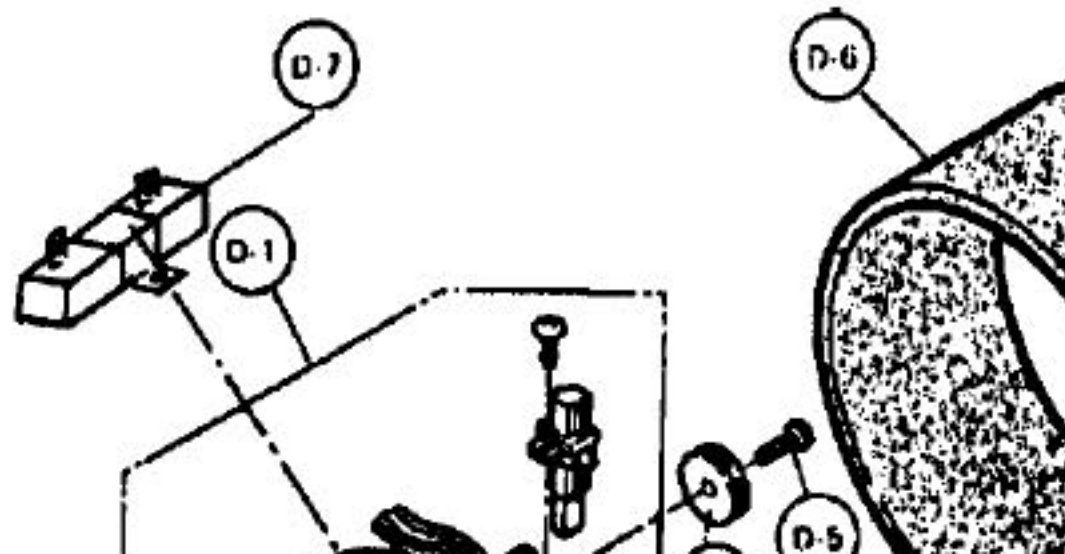

PANASONIC

Models: MC-9510, MC-9520, MC-9527, MC-9537, MC-9540

E1	P-2440	Cover, power head, 9510
E1	P-2441	Cover, power head, 9520
E1	P-000337	Cover, power head, 9527
E1	P-2442	Cover, power head, 9530,9537,9540
E2	P-844	Reflector Plate, upper
E3	P-2141	Cover, window, 9510,9520
E3	P-2142	Window, 9530,9540
E3	P-00083	Window, 9537
E4	P-8640	Reflector Plate, lower
E5	P-344	Filter, upper
E6	P-4641	Label, 9530,9540
E7	P-0246	Body, 9510
E7	P-02471	Body, 9520
E7	P-952	Body, 9527
E7	P-0247	Body, 9530,9540
E7	P-00087	Body, 9537
E8	P-394	Cord Unit
E8	P-9505	Cord Unit, 9527,9540
E9	P-9843	Switch, on/off
E10	P-04	Push Nut, 9520,9530,9540
E10	P-000331	Push Nut, 9527
E11	P-9342	Switch Indicator
E12	P-0341	Switch Holder
E12	P-0340	Switch Holder, 9527
E13	P-152	Lever, switch
E14	P-0842	Spring, pedal spacer
E15	P-7442	Spacer, pedal, 9520,9530,9540
E16	P-0542	Pedal, switch, 9520,9530,9540
E16	P-00093	Pedal, switch, 9527, 9537
E17	P-8040	Nozzle Rubber
E18	P-424	Cover, pedal, 9510
E19	P-3342	Filter, side
E20	P-374	Filter, front
E21	P-104	Furniture Guard
E21	P-00097	Furniture Guard, 9527, 9537
E22	P-0444	Button, protector, 9530,9540
E23	P-9844	Thermo Protector, 9530,9540
E24	P-1943	Protector Support, 9530,9540
E25	P-38	Screw, protector support, 9530,9540
E26	P-418	Screw, lower power nozzle
E27	P-2810	Bulb
E28	P-9343	Lamp Holder
E29	P-8541	Partition Plate
E30	P-12392	Screw, partition plate, 9530,9540
E30	P-0013	Screw, partition plate, 9527
E31	P-874	P.C.B.
E32	P-8941	Reverse Switch
E33	P-7040	Leaf Spring
E34	P-416	Screw, leaf spring, 10 pk
E35	P-9845	Pipe Insert, right
E36	P-784	Wand Connection
E36	P-00005	Wand Connection, 9527, 9537
E37	P-474	Pipe Insert, left

