

This Owner's Manual is provided and hosted by [Appliance Factory Parts](#).



# PANASONIC 9540 Owner's Manual

[Shop genuine replacement parts for PANASONIC 9540](#)

Attachments

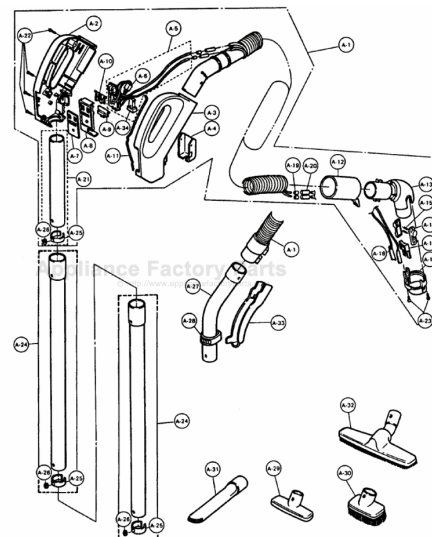

[Find Your PANASONIC Vacuum Cleaner Parts - Select From 605 Models](#)

----- Manual continues below -----

# PANASONIC

Models: MC-9510, MC-9520, MC-9527, MC-9530, MC-9

## Attachments

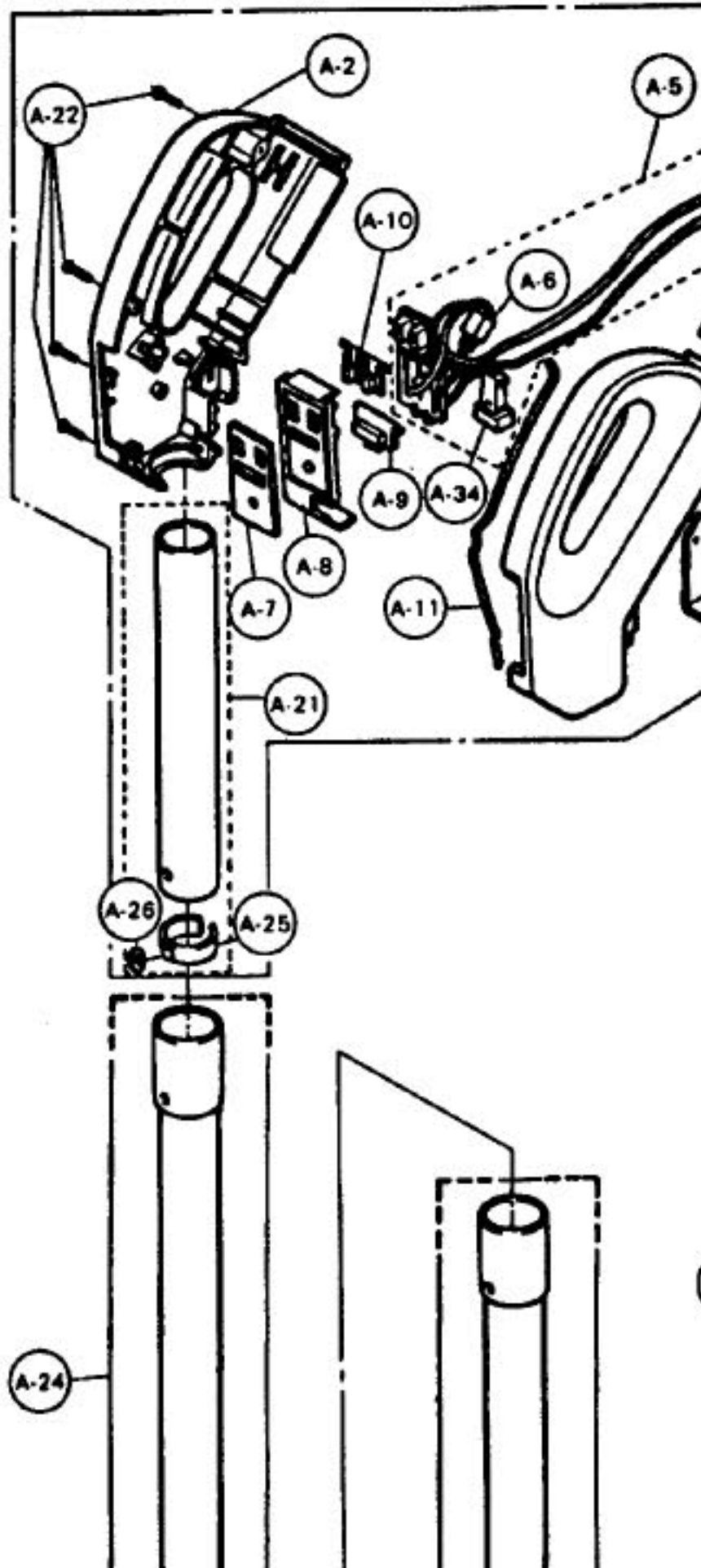

# Body Unit

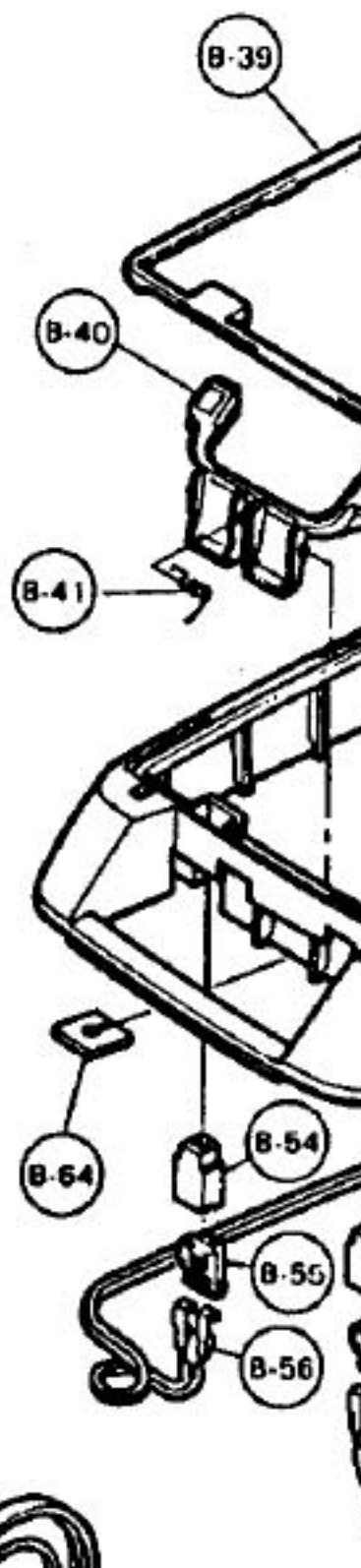
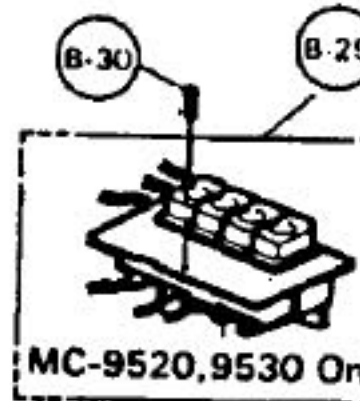
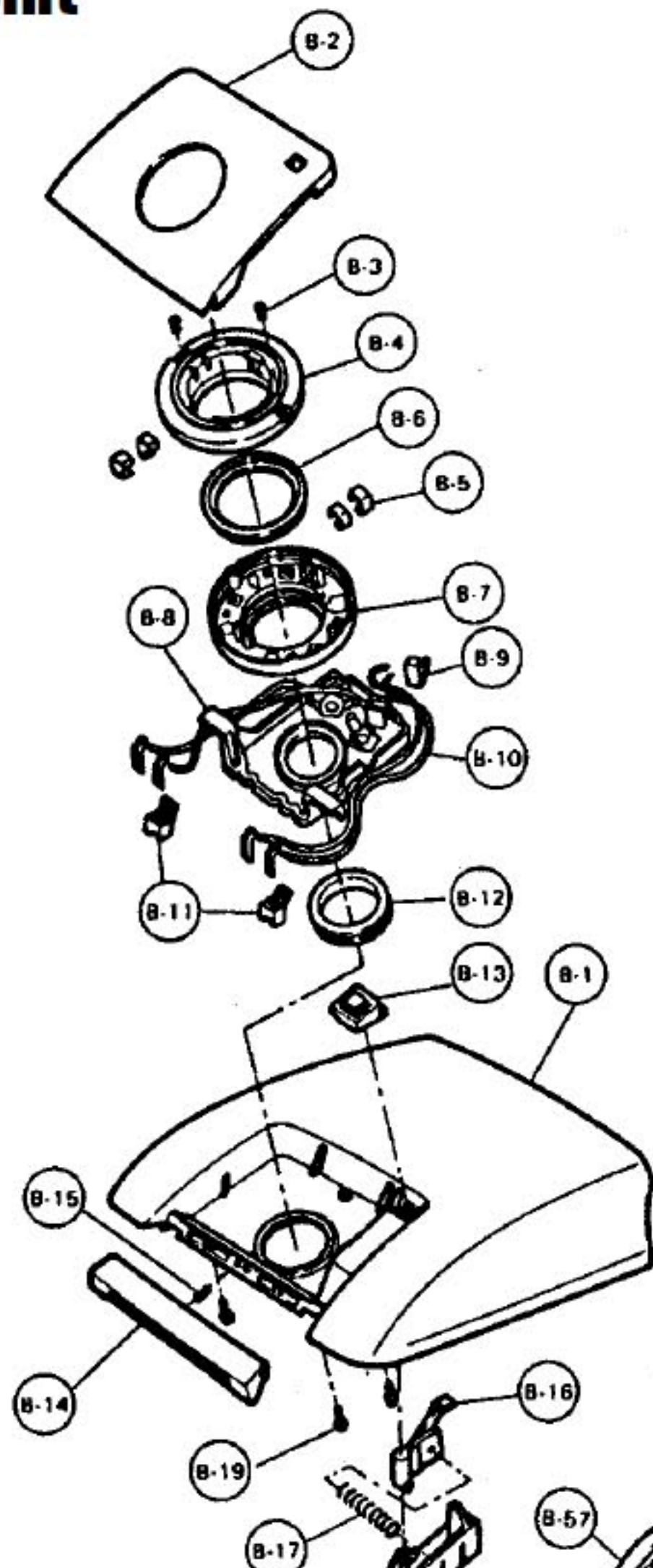

# PANASONIC

Models: MC-9510, MC-9520, MC-9527, MC-9537, MC-

B1 ....	P-6042	.....	Dust Cover
B1 ....	P-00024	.....	Dust Cover, 9527, 9537
B2 ....	P-255	.....	Front Cover
B2 ....	P-00025	.....	Front Cover, 9527, 9537
B3 ....	P-13143	.....	Screw, connection upper
B4 ....	P-6043	.....	Connection Upper
B4 ....	N/A	.....	Connection Upper, 9527, 9537
B5 ....	P-354	.....	Terminal, connection upper
B6 ....	P-644	.....	Rubber, hose fitting
B7 ....	P-174	.....	Connection Lower
B7 ....	P-00029	.....	Connection Lower, 9527, 9537
B8 ....	P-3941	.....	Contact Base
B8 ....	P-00030	.....	Contact Base, 9527, 9537
B9 ....	P-3242	.....	Sub-Switch, on / off
B10 ..	P-9341	.....	Terminal, w/ lead wire
B11 ..	P-454	.....	Holder, terminal
B11 ..	P-00031	.....	Holder, terminal, 9527
B12 ..	P-1940	.....	Dust Bag Fitting, rubber
B13 ..	P-084	.....	Window, 9510,9520,9527,9530 9537
	P-0841	.....	Front Cover Lid, 9540
B14 ..	P-0142	.....	Dust Cover Catch
B14 ..	P-00034	.....	Dust Cover Catch, 9527, 9537
B15 ..	P-18311	.....	Spring, dust cover catch
B15 ..	P-000313	.....	Spring, dust cover catch, 9527
B16 ..	P-0341	.....	Indicator
B17 ..	P-0441	.....	Spring, indicator, 9510
B17 ..	P-0442	.....	Spring, indicator
B18 ..	P-1740	.....	Cover, vac guage
B18 ..	P-00037	.....	Cover, vac guage, 9527, 9537
B19 ..	P-418	.....	Screw, dust cover
B20 ..	P-7441	.....	Tool Storage Cover
B20 ..	N/A	.....	Tool Storage Cover, 9527, 9537
B21 ..	P-0242	.....	Upper Body, 9510,9520,9530
B21 ..	P-00089	.....	Upper Body, 9527, 9537

B31  
B32  
B32  
B33  
B33  
B34  
B35  
B36  
B37  
B38  
B39  
B39  
B40  
B40  
B41  
B42  
B42  
B43  
B44  
B45  
B46  
B47  
B47  
B48  
B49  
B50  
B51  
B51  
B52  
B53  
B53  
B54  
B54

# Cord Reel Unit

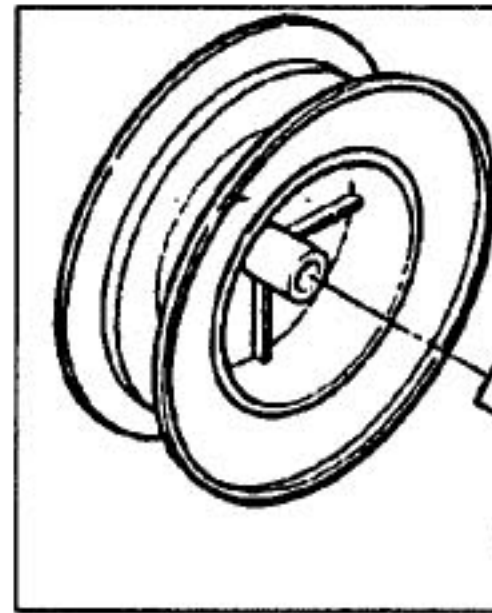

- C1 ..... N/A ..... Cord Reel Unit, 9510
- C1 ..... P-9940 ..... Cord Reel Unit, 9520,9530,9540
- C1 ..... P-000334 ..... Cord Reel Unit, 9527
- C1 ..... P-00071 ..... Cord Reel Unit, 9537
- C2 ..... P-12399 ..... Power Cord, w/ rail base, 9510
- C2 ..... P-9842 ..... Power Cord, w/ rail base, 9520,  
9530,9540
- C2 ..... P-000335 ..... Power Cord, w/ rail base, 9527
- C2 ..... P-00072 ..... Power Cord, w/ rail base, 9537
- C3 ..... P-9443 ..... Brake Lever
- P-000336 ..... Brake Spring, 9527
- C5 ..... P-1941 ..... Contact Base Unit, 9510
- C5 ..... P-1942 ..... Contact Base Unit
- C6 ..... P-0443 ..... Body Partition
- C7 ..... P-416 ..... Screw, C6,C5, 10 pack

# Motor Unit

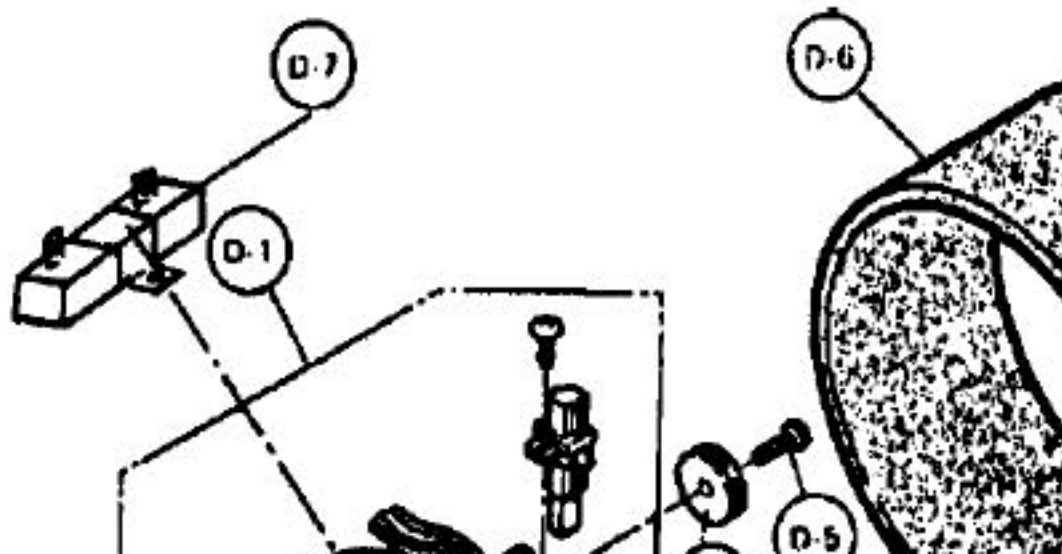

# PANASONIC

Models: MC-9510, MC-9520, MC-9527, MC-9537, MC-9540

E1	P-2440	Cover, power head, 9510
E1	P-2441	Cover, power head, 9520
E1	P-000337	Cover, power head, 9527
E1	P-2442	Cover, power head, 9530,9537,9540
E2	P-844	Reflector Plate, upper
E3	P-2141	Cover, window, 9510,9520
E3	P-2142	Window, 9530,9540
E3	P-00083	Window, 9537
E4	P-8640	Reflector Plate, lower
E5	P-344	Filter, upper
E6	P-4641	Label, 9530,9540
E7	P-0246	Body, 9510
E7	P-02471	Body, 9520
E7	P-952	Body, 9527
E7	P-0247	Body, 9530,9540
E7	P-00087	Body, 9537
E8	P-394	Cord Unit
E8	P-9505	Cord Unit, 9527,9540
E9	P-9843	Switch, on/off
E10	P-04	Push Nut, 9520,9530,9540
E10	P-000331	Push Nut, 9527
E11	P-9342	Switch Indicator
E12	P-0341	Switch Holder
E12	P-0340	Switch Holder, 9527
E13	P-152	Lever, switch
E14	P-0842	Spring, pedal spacer
E15	P-7442	Spacer, pedal, 9520,9530,9540
E16	P-0542	Pedal, switch, 9520,9530,9540
E16	P-00093	Pedal, switch, 9527, 9537
E17	P-8040	Nozzle Rubber
E18	P-424	Cover, pedal, 9510
E19	P-3342	Filter, side
E20	P-374	Filter, front
E21	P-104	Furniture Guard
E21	P-00097	Furniture Guard, 9527, 9537
E22	P-0444	Button, protector, 9530,9540
E23	P-9844	Thermo Protector, 9530,9540
E24	P-1943	Protector Support, 9530,9540
E25	P-38	Screw, protector support, 9530,9540
E26	P-418	Screw, lower power nozzle
E27	P-2810	Bulb
E28	P-9343	Lamp Holder
E29	P-8541	Partition Plate
E30	P-12392	Screw, partition plate, 9530,9540
E30	P-0013	Screw, partition plate, 9527
E31	P-874	P.C.B.
E32	P-8941	Reverse Switch
E33	P-7040	Leaf Spring
E34	P-416	Screw, leaf spring, 10 pk
E35	P-9845	Pipe Insert, right
E36	P-784	Wand Connection
E36	P-00005	Wand Connection, 9527, 9537
E37	P-474	Pipe Insert, left

