

This Owner's Manual is provided and hosted by [Appliance Factory Parts](#).



WHIRLPOOL MT1131SGQ Owner's Manual

[Shop genuine replacement parts for WHIRLPOOL
MT1131SGQ](#)

DOOR PARTS

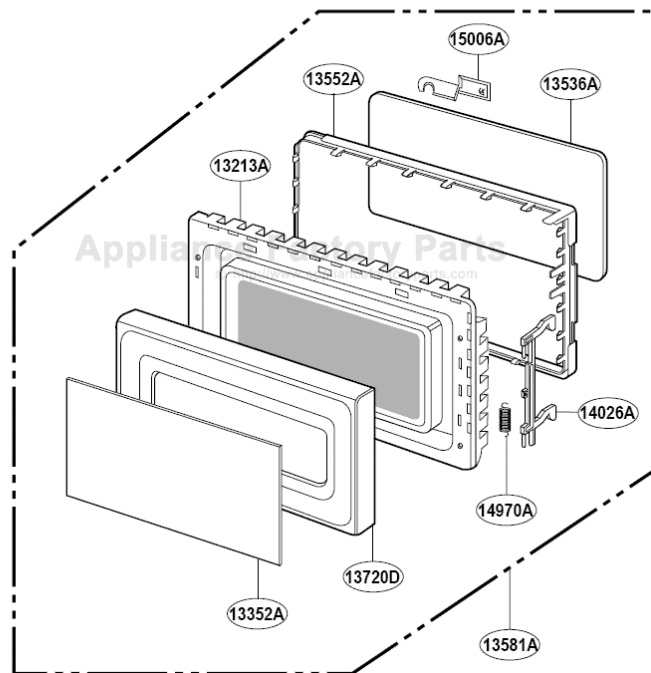

[Find Your WHIRLPOOL Microwave Parts - Select From 1350 Models](#)

----- Manual continues below -----

DOOR PARTS

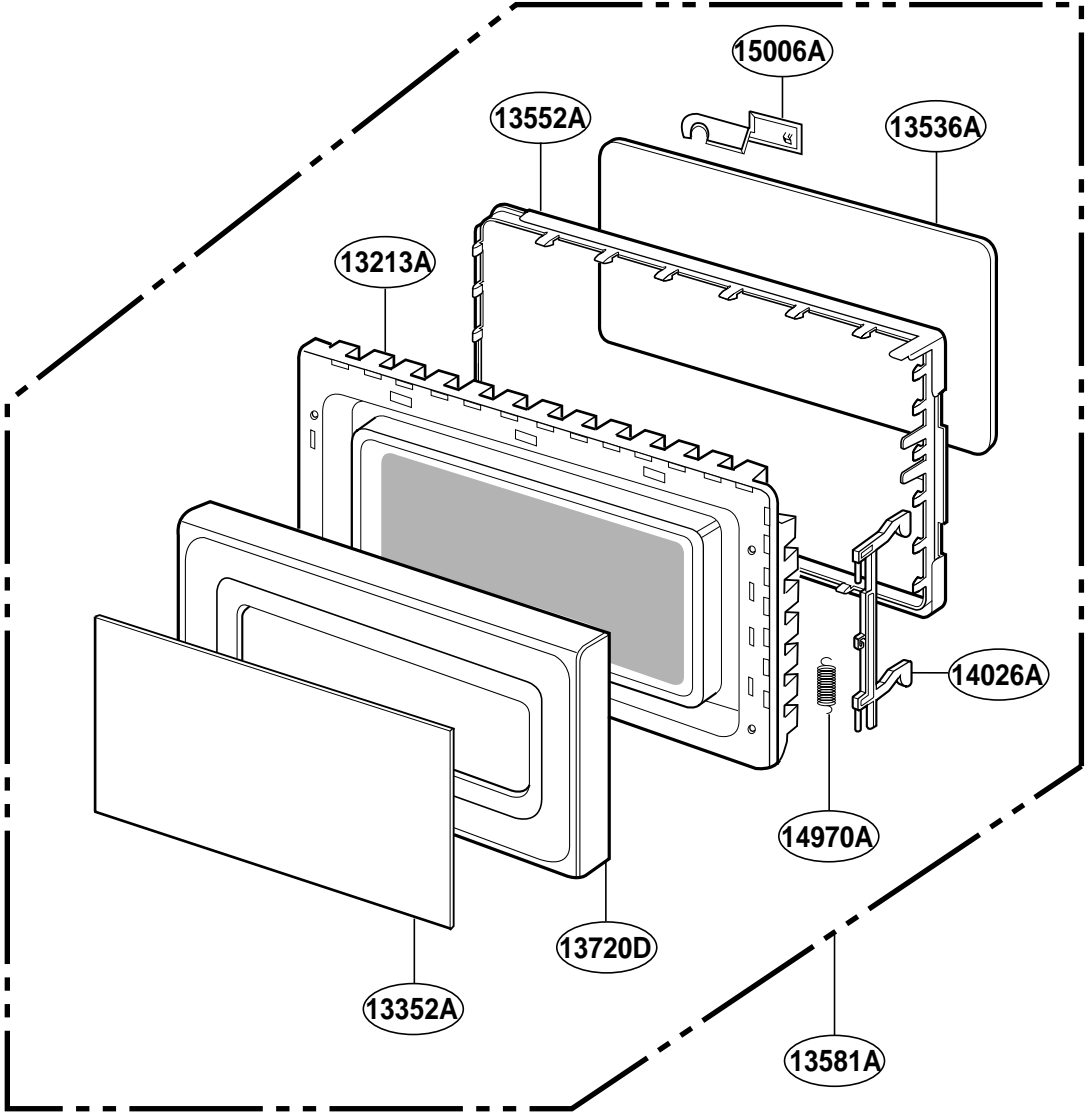

CONTROLLER PARTS

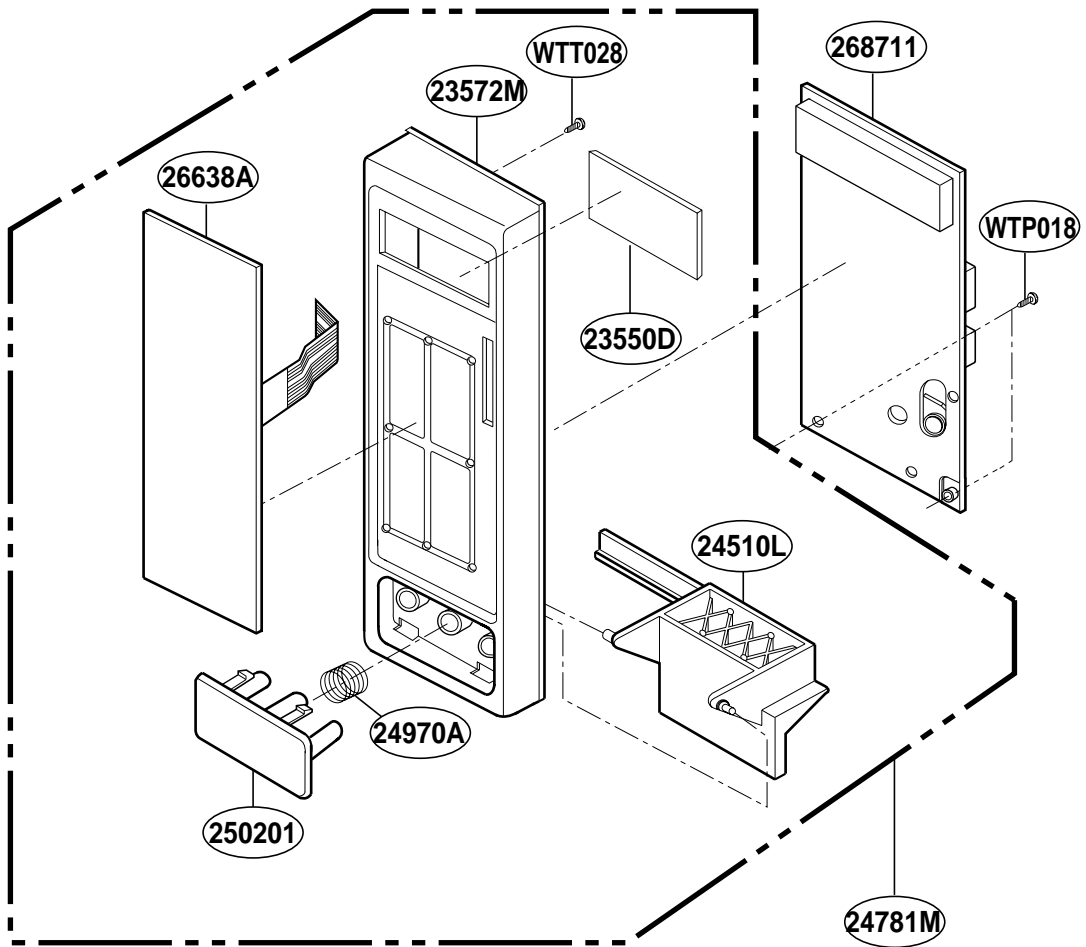

OVEN CAVITY PARTS

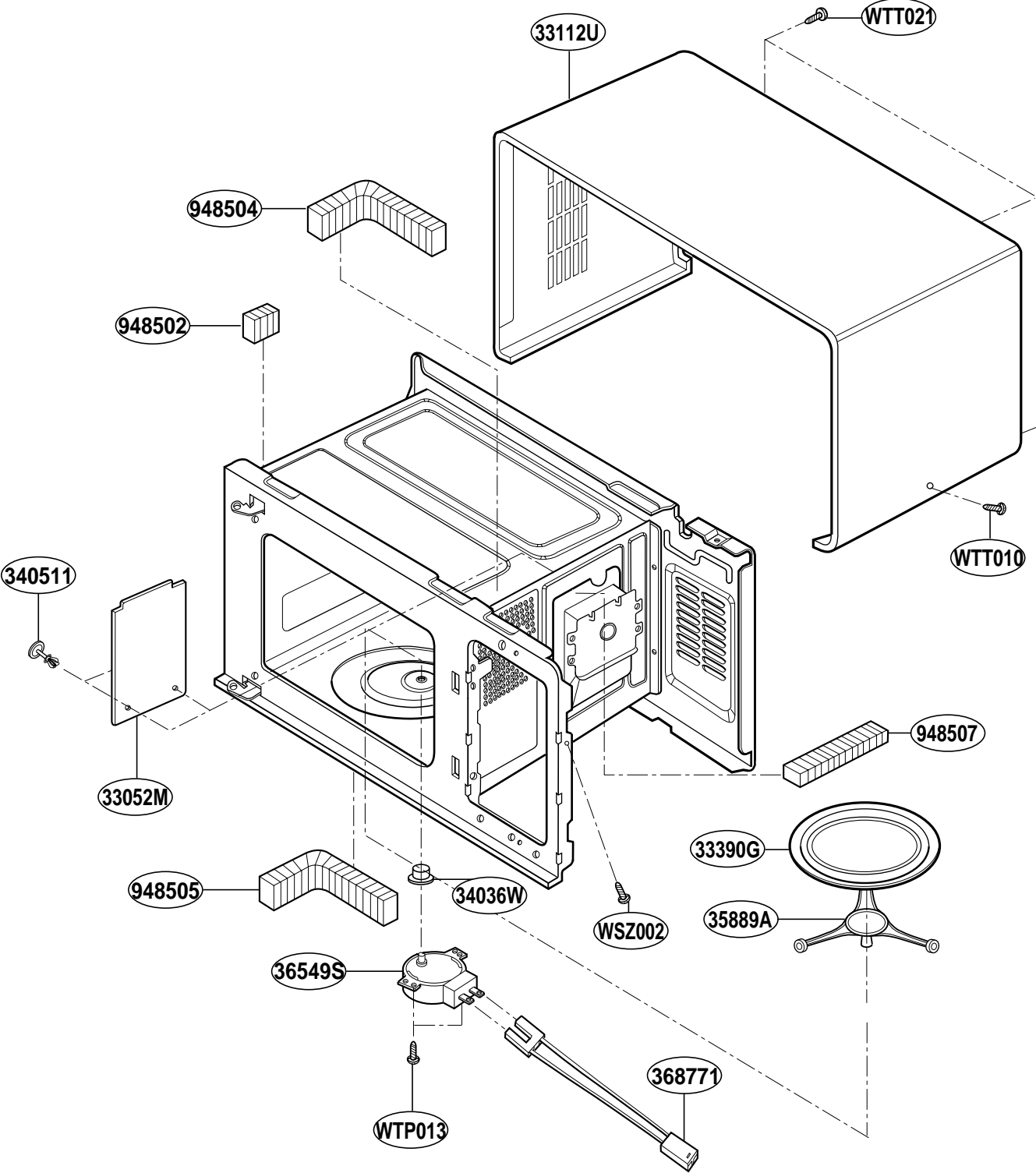

SUCTION GUIDE PARTS

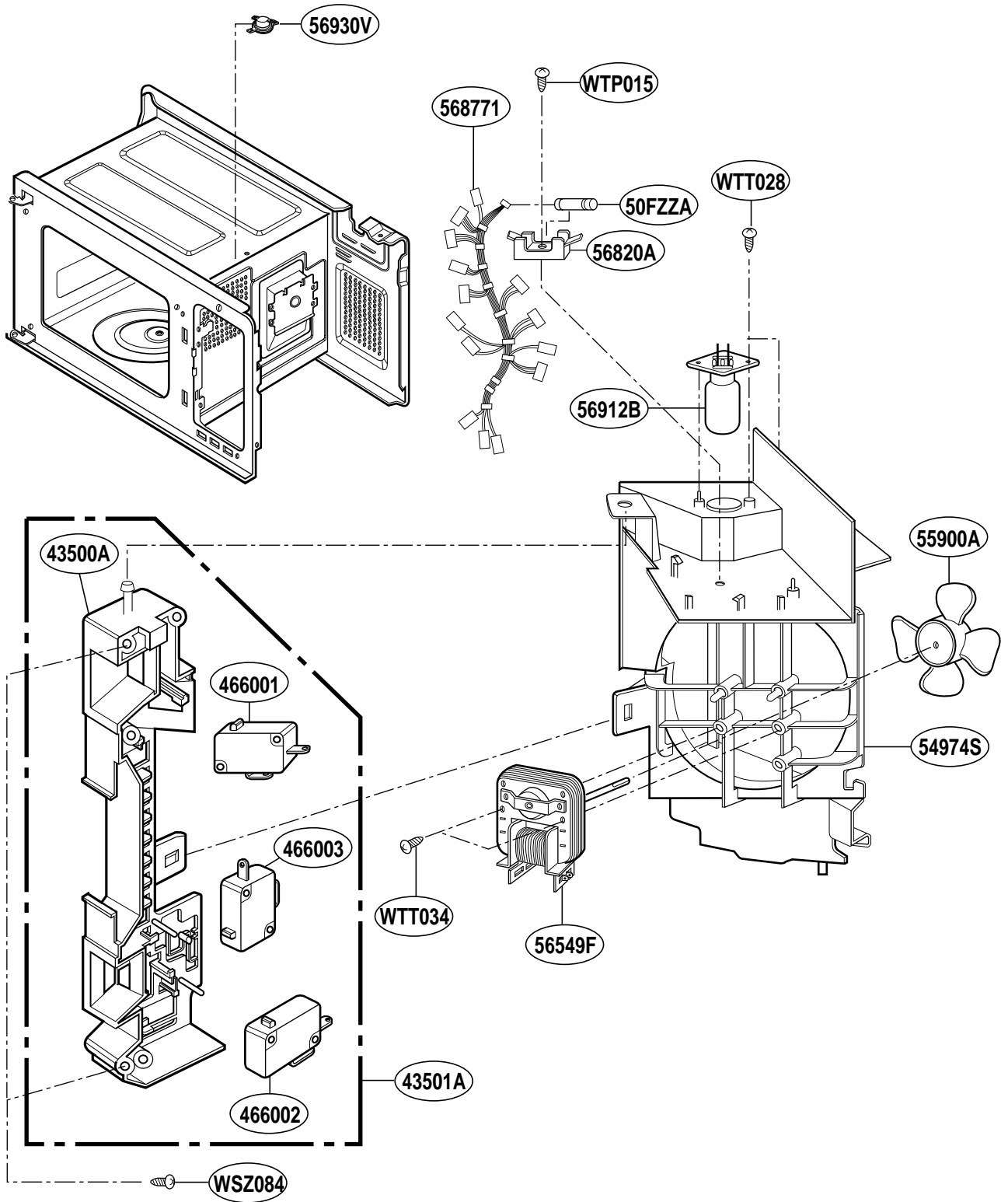

INTERIOR PARTS

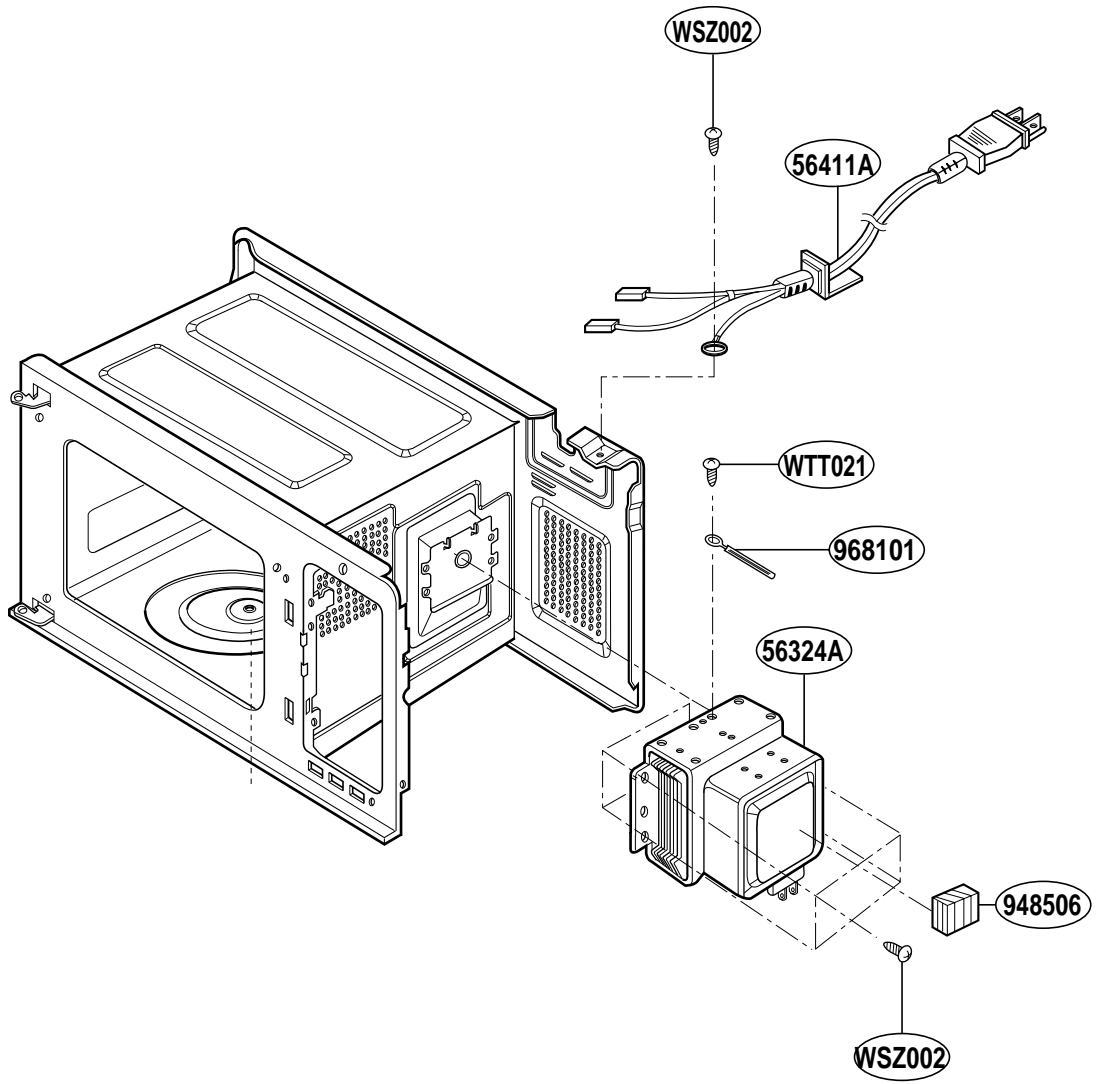

BASE PLATE PARTS

