



**LG** PRIVILEGE

website: <http://www.LGService.com>  
e-mail: <http://www.LGService.com/techsup.html>

# MICROWAVE OVEN **SERVICE MANUAL**

**MODEL: MV-1760T, MV-1765S  
MV-1761T, MV-1766S**

**CAUTION**

BEFORE SERVICING THE UNIT, READ THE  
SAFETY PRECAUTIONS IN THIS MANUAL.

# **CAUTION**

## **SAFETY PRECAUTIONS**

### **PRECAUTIONS TO BE OBSERVED BEFORE AND DURING SERVICING TO AVOID POSSIBLE EXPOSURE TO EXCESSIVE MICROWAVE ENERGY**

- a. Do not operate or allow the oven to be operated with the door open.**
- b. Make the following safety checks on all ovens to be serviced before activating the magnetron or other microwave source, and make repairs as necessary; (1) Interlock operation, (2) proper door closing, (3) seal and sealing surfaces (arcing, wear, and other damage), (4) damage to or loosening of hinges and latches, (5) evidence of dropping or abuse.**
- c. Before turning on microwave power for any service test or inspection within the microwave generating compartments, check the magnetron, wave guide or transmission line, and cavity for proper alignment, integrity, and connections.**
- d. Any defective or misadjusted components in the interlock, monitor, door seal, and microwave generation and transmission systems shall be repaired, replaced, or adjusted by procedures described in this manual before the oven is released to the owner.**
- e. A Microwave leakage check to verify compliance with the CSA Standard should be performed on each oven prior to release to the owner.**
  - Proper operation of the microwave ovens requires that the magnetron be assembled to the wave guide and cavity. Never operate the magnetron unless it is properly installed.
  - Be sure that the magnetron gasket is properly installed around the dome of the tube whenever installing the magnetron.
  - Routine service safety procedures should be exercised at all times.
  - Untrained personnel should not attempt service without a thorough review of the test procedures and safety information contained in this manual.

## FOREWORD

Read this Manual carefully. Failure to adhere to or observe the information in this Manual may result in exposing yourself to the Microwave Energy normally contained within the oven cavity.

## TABLE OF CONTENTS

	(Page)
SAFETY PRECAUTIONS .....	Inside front page
SPECIFICATIONS .....	1-1
CAUTIONS .....	2-1
INSTALLATIONS .....	3-1
OPERATING INSTRUCTIONS .....	4-1
CONTROL PANEL .....	4-1
CONTROL PANEL INSTRUCTIONS .....	4-2
OVERALL CIRCUIT DIAGRAM .....	5-1
SCHEMATIC DIAGRAM .....	5-1
MATRIX CIRCUIT FOR TOUCH KEY BOARD .....	5-2
GENERAL INFORMATION FOR SERVICE .....	6-1
GENERAL PRECAUTIONS IN USE .....	6-1
TRIAL OPERATION .....	6-1
FEATURES AND SPECIFICATIONS FEATURES .....	6-1
SERVICE INFORMATION .....	7-1
PRECAUTIONS AND REPAIR SERVICE TIPS .....	7-1
MICROWAVE LEAKAGE TEST .....	7-2
POWER OUTPUT MEASUREMENT .....	7-3
DISASSEMBLY INSTRUCTIONS .....	7-4
INTERLOCK SYSTEM .....	7-12
INTERLOCK CONTINUITY TEST .....	7-14
TEST AND CHECKOUT PROCEDURES AND TROUBLE SHOOTING .....	7-15
A. TEST PROCEDURES .....	7-15
B. CHECKOUT PROCEDURES .....	7-18
C. TROUBLE SHOOTING .....	7-21
EXPLODED VIEW .....	8-1
REPLACEMENT PARTS LIST .....	8-8
SCHEMATIC DIAGRAM OF PCB .....	8-16
PRINTED CIRCUIT BOARD .....	8-17
PCB PARTS LIST .....	8-18

# SPECIFICATIONS

Rated Power Consumption .....	1,500W maximum (Microwave oven only)
Microwave Output .....	1000W (IEC 60 705)
	Adjustable 100W through 1000W, 10 steps
Frequency .....	2,450 MHz $\pm$ 50 MHz
Power Supply .....	120 VAC, 60 Hz
Rated Current .....	13 Amp. (Microwave oven+Cook top lamps+Ventilation fan)
Magnetron Cooling .....	Forced Air Cooling
Rectification .....	Rectification Voltage Double Half-Wave
Door Sealing .....	Choke System
Safety Devices .....	Magnetron Thermal Fuse: Open at 109°C $\pm$ 4°C
	Oven Cavity Thermostat: Open at 110°C $\pm$ 5°C
	Fuse(20A)
	Primary Interlock Switch
	Secondary Interlock Switch
	Interlock Monitor
Magnetron .....	2M246-050GF or 2M248J
High Voltage Capacitor .....	Capacitor: 1.0 $\mu$ F, 2.1 KV AC
High Voltage Diode .....	Diode; 350mA, 9.0 KV
Cook top Lamp .....	125 V, 30 W or 40 W
Cavity Lamp .....	125 V, 30 W
Timer .....	Digital, up to 99 mim. 99 sec. (in each cooking stage)
Tray .....	Tempered Safety Glass
Overall Dimensions .....	29 <sup>15/16</sup> "(W)x16 <sup>7/16</sup> "(D)x15 <sup>1/2</sup> "(H)
Effective Capacity of Oven Cavity .....	1.7 Cu.ft.
Accessories .....	Owner's Manual & Cooking Guide, Installation Manual, Exhaust Adapter, Exhaust Damper, Mounting Kit and Two Filters, Rotating Ring Assembly, Metal Rack.

# CAUTIONS

Unlike other appliances, the microwave oven is high-voltage and high-current equipment. Though it is free from danger in ordinary use, extreme care should be taken during repair.

- DO NOT operate on a 2-wire extension cord during repair and use.
- NEVER TOUCH any oven components or wiring during operation.
- BEFORE TOUCHING any parts of the oven, always remove the power plug from the outlet.
- For about 30 seconds after the oven stops, an electric charge remains in the high voltage capacitor. When replacing or checking, you must discharge the high voltage capacitor by shorting across the two terminals with an insulated screwdriver.

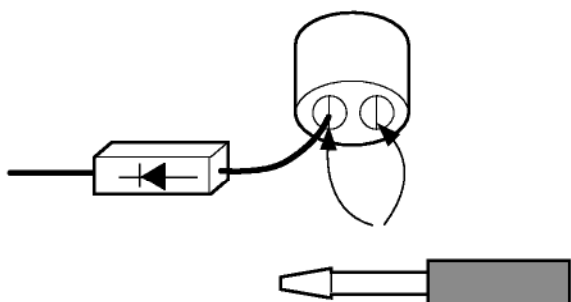

- Remove your watches whenever working close to or replacing the Magnetron.
- DO NOT touch any parts of the control panel circuit. A resulting static electric discharge may damage this P.C.B.
- NEVER operate the oven with no load.
- NEVER injure the door seal and front plate of the oven cavity.
- NEVER put iron tools on the magnetron.
- NEVER put anything into the latch hole and the interlock switches area.

## MICROWAVE RADIATION

Personnel should not be exposed to the microwave energy which may radiate from the magnetron or other microwave generating device if it is improperly used or connection. All input and output microwave connections, waveguide, flange, and gasket must be secure never operate the device without a microwave energy absorbing load attached. Never look into an open waveguide or antenna while the device is energized.

- Proper operation of the microwave oven requires that the magnetron be assembled to the waveguide and cavity. Never operate the magnetron unless it is properly installed.
- **Be sure that the magnetron gasket is properly installed around the dome of the tube whenever installing the magnetron.**

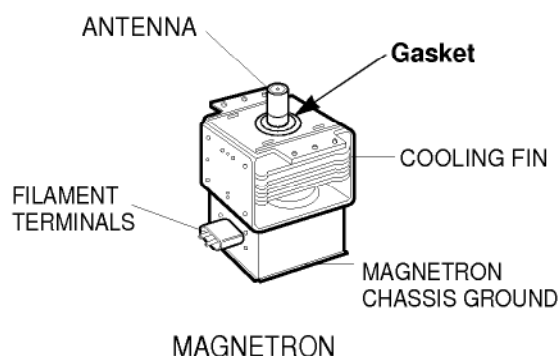

**THE OVEN IS TO BE SERVICED ONLY BY PROPERLY QUALIFIED SERVICE PERSONNEL.**

# INSTALLATIONS

**BEFORE YOU BEGIN, READ THE FOLLOWING INSTRUCTIONS COMPLETELY AND CAREFULLY.**

## ***PRECAUTIONS ON INSTALLATION***

- A. Plug the power supply cord into a 120V AC, 60Hz, single-phase power source with a capacity of 15A or 20A.
- B. Avoid placing the unit in a location where there is direct heat or splashing water.
- C. Install the unit on the mounting plate firmly.
- D. Place the unit as far away as possible from TV, radio, etc. to prevent interference.

## ***GROUNDING INSTRUCTIONS***

For personal safety, this appliance must be fully grounded at all times.

In the event of an electrical short circuit, grounding reduces the risk of electrical shock.

The plug must be plugged into an outlet that is properly installed and grounded.

## **CAUTION**

This unit is equipped with a 3-prong plug for your safety. If the wall outlet is a grounded 3-hole type, the unit will be grounded automatically.

**Plug with Ground  
Prong**

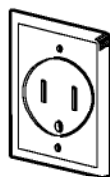

**Properly Polarized  
and Grounded  
Outlet**

## **WARNING**

Improper use of the grounding plug can result in a risk of electric shock.

Do not, under any circumstances, cut or remove the third ground prong from the power cord plug.

# OPERATING INSTRUCTIONS

## CONTROL PANEL

For Model MV-1760T  
MV-1761T



For Model MV-1765S  
MV-1766S

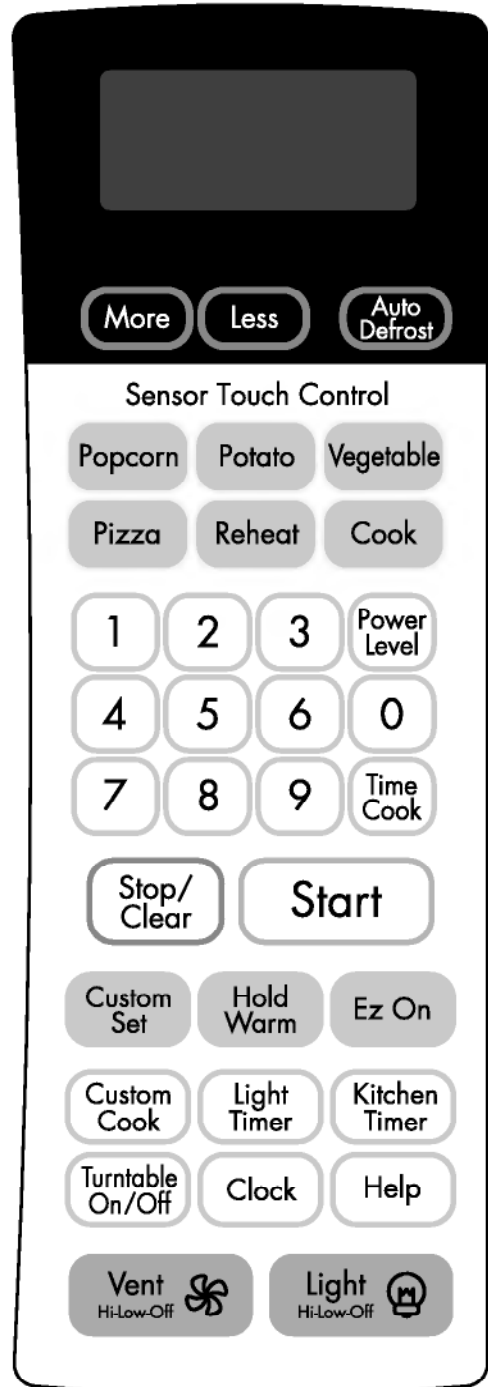

## CONTROL PANEL INSTRUCTIONS

---

- 1. DISPLAY:** The display includes a clock and indicators to tell you time of day, cooking time settings, and cooking functions selected.
- 2. MORE:** Press this pad to add ten seconds of cooking time each time you press it.
- 3. LESS:** Press this pad to subtract ten seconds of cooking time each time you press it.
- 4. AUTO DEFROST:** Press this pad to select food type and defrost food by weight.
- 5. ONE TOUCH CONTROL:** Press these keys let you cook foods easily.
- 6. SENSOR TOUCH CONTROL:** Used to cook common microwave-prepared foods without needing to program times and cook powers.
- 7. NUMBER:** Press number pads to enter cooking time, power level, quantities, or weights.
- 8. POWER LEVEL:** Press this pad to select a cooking power level.
- 9. TIME COOK:** Press this pad followed by Number Pads to set a cooking time.
- 10. STOP/CLEAR:** Press this pad to stop the oven or to clear all entries.
- 11. START:** Press this pad to start a function. If you open the door after oven begins to cook, START again.
- 12. CUSTOM SET:** Press this pad to change the oven's default settings for sound, clock, display speed, defrost weight, and demo mode operations.
- 13. HOLD WARM:** Press this pad to keep hot, cooked foods safely warm in your microwave oven for up to 99 minutes 99 seconds.
- 14. EZ ON:** Press this pad to cook for 30 seconds at 100% power level.
- 15. CUSTOM COOK:** Press this pad to recall one cooking instruction previously programmed into memory.
- 16. LIGHT TIMER:** Press this pad to set the light timer.
- 17. KITCHEN TIMER:** Press this pad to set the kitchen timer.
- 18. TURNTABLE ON/OFF:** Press this pad to turn off the turntable. OFF will appear in the display.
- 19. HELP:** Press this pad to learn how to use each oven function.
- 20. CLOCK(TIME OF DAY):** Press this pad to enter the time of day.
- 21. VENT HI/LOW/OFF:** Press this pad to turn the fan on or off.
- 22. LIGHT HI/LOW/OFF:** Press this pad to turn on the cooktop/countertop light.



# OVERALL CIRCUIT DIAGRAM

## SCHEMATIC DIAGRAM

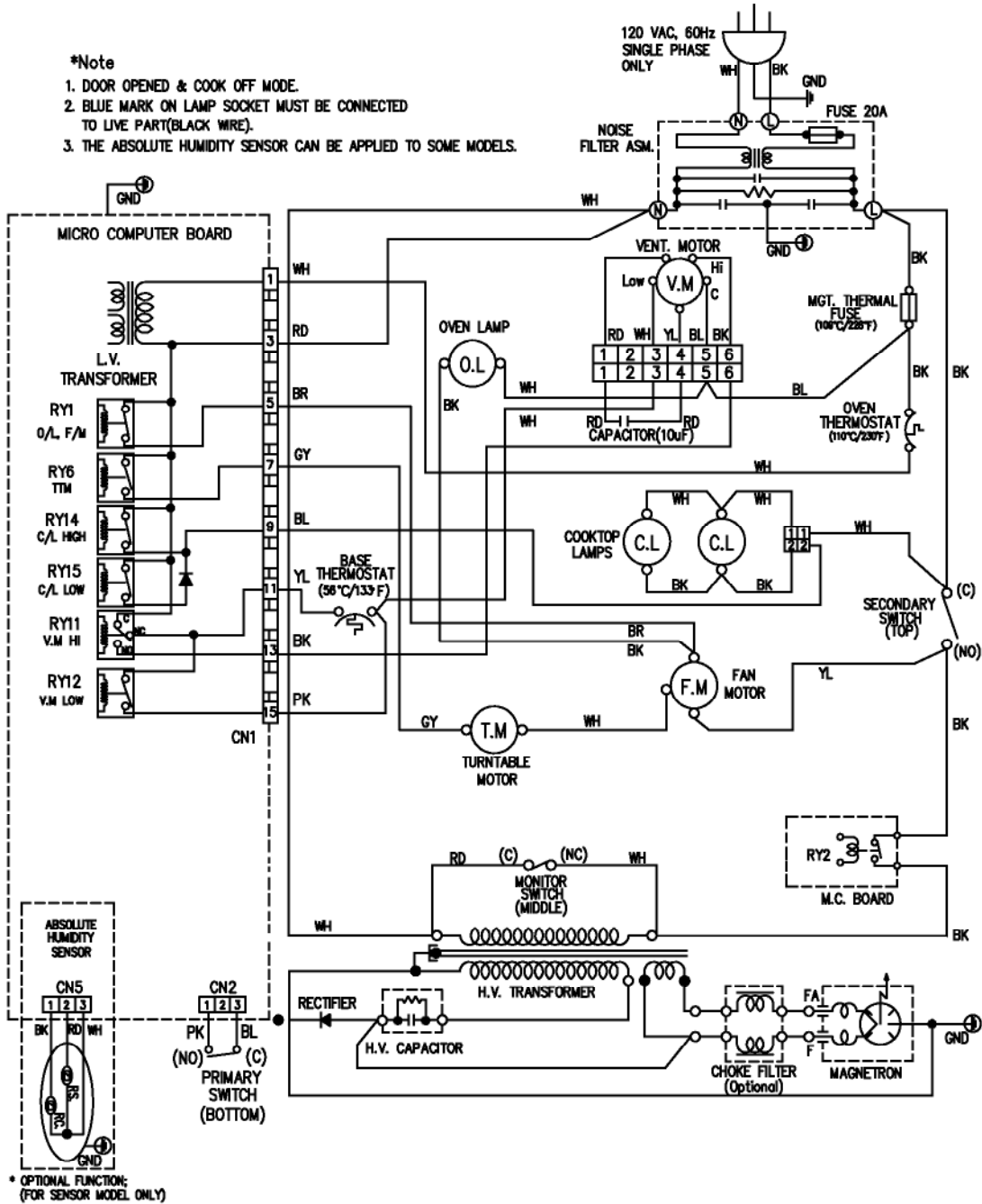

### CONTROL MODULE

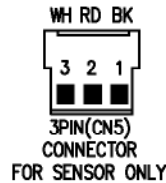
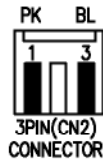
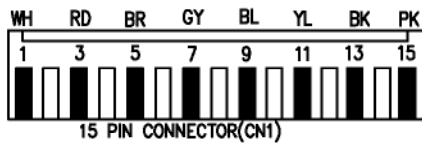

### WIRE COLORS

SYMBOL	COLOR
WH	WHITE
BK	BLACK
RD	RED
YL	YELLOW
PK	PINK
BL	BLUE
BR	BROWN
GN	GREEN
GY	GREY

# MATRIX CIRCUIT FOR TOUCH KEY BOARD

For Model MV-1760T  
MV-1761T

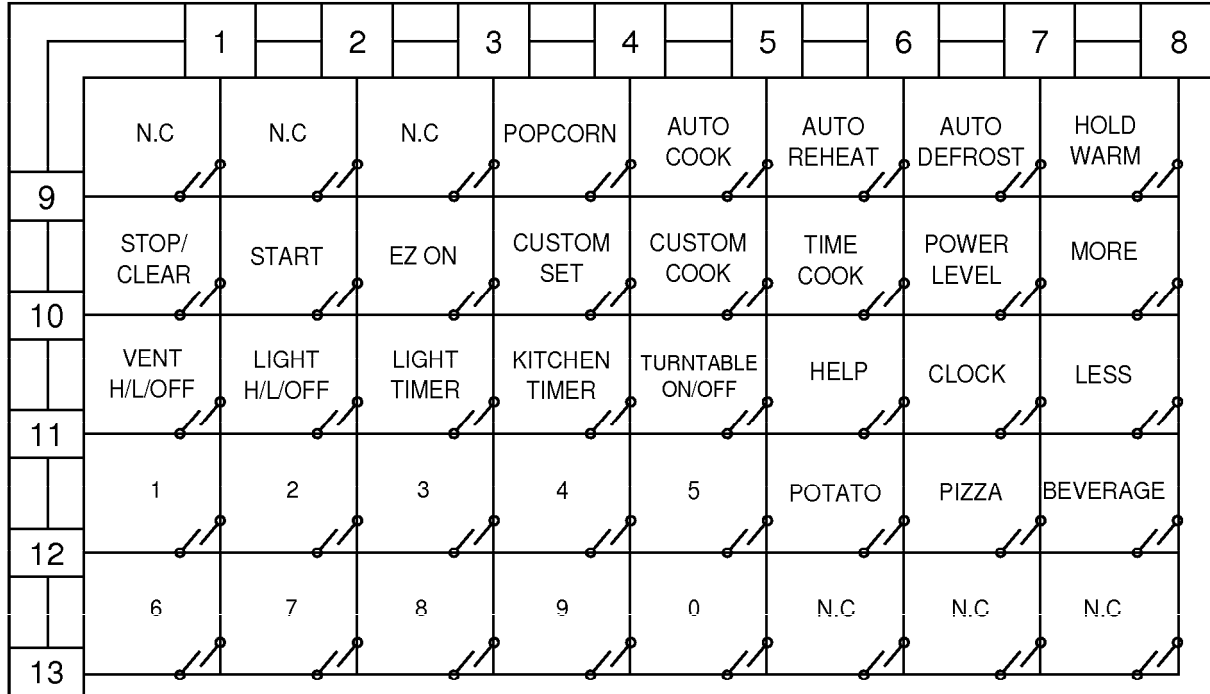

For Model MV-1765S  
MV-1766S

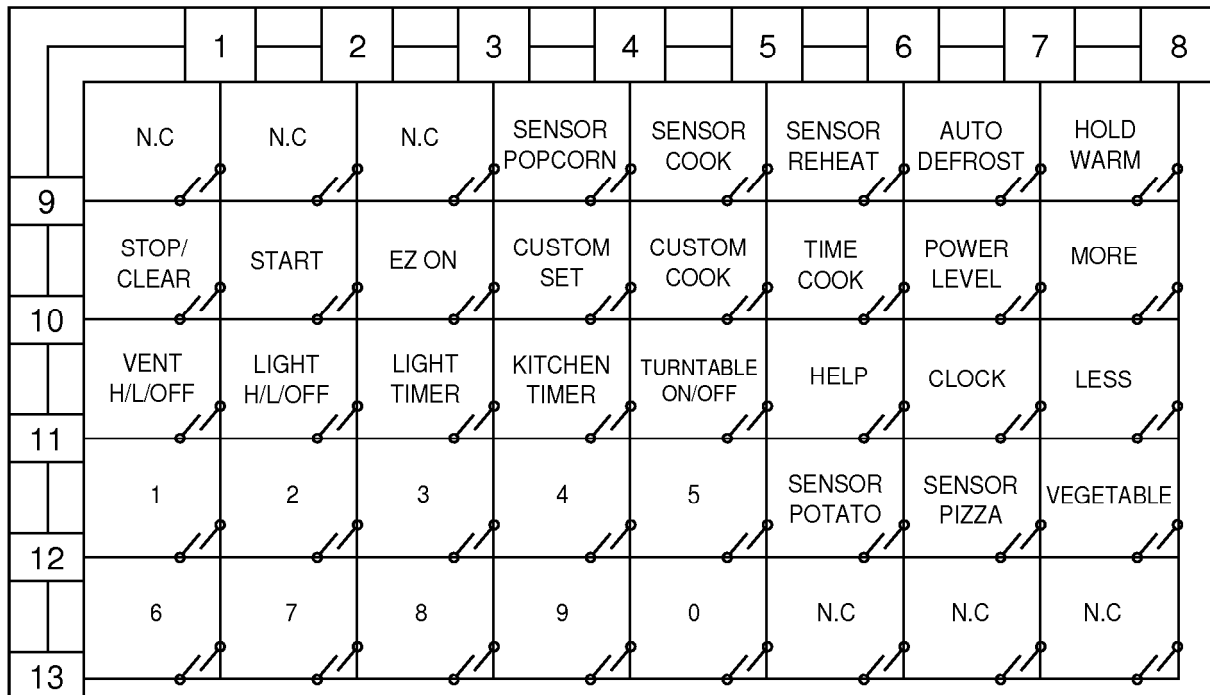

# GENERAL INFORMATION FOR SERVICE

## GENERAL PRECAUTIONS IN USE

### A. **Never operate the unit when it is empty.**

Operating the oven with no load may shorten the life of the magnetron. Whenever cooking dry foods (dried fish, bread, etc.) or a small amount of food, be sure to put a glass of water into the cooking compartment. The glass turntable may become hot after operating, be careful when touching it.

### B. Aluminum foil should be avoided because it will disrupt cooking and may cause arcing. However, small pieces may be used to cover some parts of food to slow the cooking. Any aluminum foil used should never be closer than 2.5 cm to any side wall of the oven.

- (1) Primary interlock switch
- (2) Secondary interlock switch
- (3) Interlock monitor switch
- (4) Choke system
- (5) Magnetron thermal fuse
- (6) Oven cavity thermostat

**(Note:** This thermostat located on the oven cavity will open and stop the unit from operation only if a high temperature is reached, such as, a fire created by overcooking food.)

### B. Any one of 10 power output levels ranging 100W to 1000W can be selected by the touch control and electronic computer system.

## TRIAL OPERATION

After installation, the following sequences and results should be checked carefully.

- A. Put a container filled with water (about 1 liter) into the oven, and close the door tightly.
- B. Set cooking time for 10 minutes by touching "1" and then "0" three times. "1, 0, 0, 0" appears in the display window.
- C. Touch the START key.  
Make sure the cavity light comes on. The unit will begin cooking and the display window will show the time counting down by seconds.
- D. After about 5 minutes, make sure the primary interlock switch, the secondary interlock switch and the interlock monitor switch operate properly by opening and closing the door several times. Touch the START key each time the door is closed.
- E. Continue operating the unit. Four long beep sound signal is heard when the time is up. The unit will shut off automatically.
- F. Confirm the water is hot.
- G. Finally, measure the output power according to "POWER OUTPUT MEASUREMENT" on page 7-3.

## FEATURES AND SPECIFICATIONS

### FEATURES

- A. The safety systems incorporated in this model are: