

This Owner's Manual is provided and hosted by [Appliance Factory Parts](http://ApplianceFactoryParts.com).



AMANA MVH150E Owner's Manual

[Shop genuine replacement parts for AMANA MVH150E](#)

EXPLODED VIEW DOOR PARTS

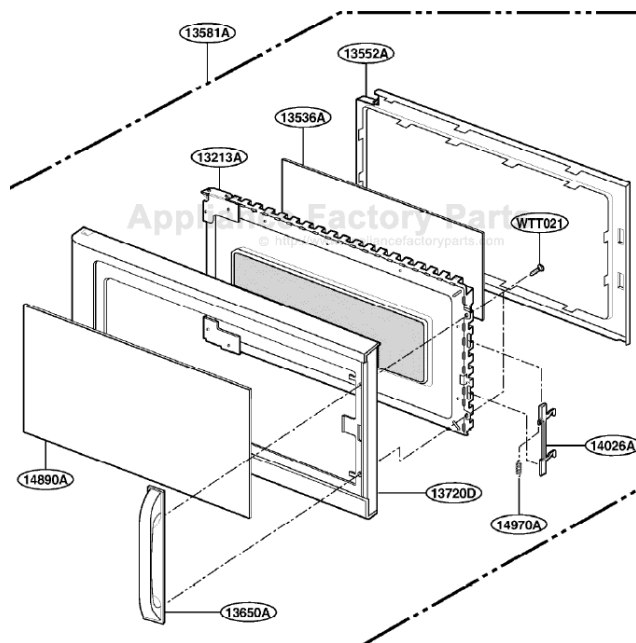

[Find Your AMANA Microwave Parts - Select From 149 Models](#)

----- Manual continues below -----

Amana[®]

**Over-The-Range
Microwave Oven
Service Manual**

**MVH150E
MVH150W**

CAUTION

BEFORE SERVICING THE UNIT, READ THE
SAFETY PRECAUTIONS IN THIS MANUAL.

CAUTION

SAFETY PRECAUTIONS

PRECAUTIONS TO BE OBSERVED BEFORE AND DURING SERVICING TO AVOID POSSIBLE EXPOSURE TO EXCESSIVE MICROWAVE ENERGY

- a. Do not operate or allow the oven to be operated with the door open.**
 - b. Make the following safety checks on all ovens to be serviced before activating the magnetron or other microwave source, and make repairs as necessary; (1) Interlock operation, (2) proper door closing, (3) seal and sealing surfaces (arcing, wear, and other damage), (4) damage to or loosening of hinges and latches, (5) evidence of dropping or abuse.**
 - c. Before turning on microwave power for any service test or inspection within the microwave generating compartments, check the magnetron, wave guide or transmission line, and cavity for proper alignment, integrity, and connections.**
 - d. Any defective or misadjusted components in the interlock, monitor, door seal, and microwave generation and transmission systems shall be repaired, replaced, or adjusted by procedures described in this manual before the oven is released to the owner.**
 - e. A Microwave leakage check to verify compliance with the Federal Performance Standard and CSA Standard should be performed on each oven prior to release to the owner.**
- Proper operation of the microwave ovens requires that the magnetron be assembled to the wave guide and cavity. Never operate the magnetron unless it is properly installed.
 - Be sure that the magnetron gasket is properly installed around the dome of the tube whenever installing the magnetron.
 - Routine service safety procedures should be exercised at all times.
 - Untrained personnel should not attempt service without a thorough review of the test procedures and safety information contained in this manual.

FOREWORD

Read this Manual carefully. Failure to adhere to or observe the information in this Manual may result in exposing yourself to the Microwave Energy normally contained within the oven cavity.

TABLE OF CONTENTS

	(Page)
SAFETY PRECAUTIONS	Inside front page
SPECIFICATIONS	1-1
CAUTIONS	2-1
INSTALLATIONS	3-1
OPERATING INSTRUCTIONS.....	4-1
CONTROL PANEL	4-1
CONTROL PANEL INSTRUCTIONS	4-2
OVERALL CIRCUIT DIAGRAM	5-1
SCHEMATIC DIAGRAM.....	5-1
MATRIX CIRCUIT FOR TOUCH KEY BOARD	5-2
GENERAL INFORMATION FOR SERVICE	6-1
GENERAL PRECAUTIONS IN USE	6-1
TRIAL OPERATION	6-1
FEATURES AND SPECIFICATIONS FEATURES.....	6-1
SERVICE INFORMATION	7-1
PRECAUTIONS AND REPAIR SERVICE TIPS.....	7-1
MICROWAVE LEAKAGE TEST	7-2
POWER OUTPUT MEASUREMENT	7-3
DISASSEMBLY INSTRUCTIONS	7-4
INTERLOCK SYSTEM	7-12
INTERLOCK CONTINUITY TEST.....	7-14
TEST AND CHECKOUT PROCEDURES AND TROUBLE SHOOTING.....	7-15
A. TEST PROCEDURES.....	7-15
B. CHECKOUT PROCEDURES.....	7-18
C. TROUBLE SHOOTING	7-21
EXPLODED VIEW	8-1
REPLACEMENT PARTS LIST	8-8
SCHEMATIC DIAGRAM OF PCB	8-14
PRINTED CIRCUIT BOARD	8-15
PCB PARTS LIST.....	8-16

SPECIFICATIONS

Rated Power Consumption	1,400W maximum (Microwave oven only) 1,500W maximum (Microwave oven+Cook top lamps+Ventilation fan)
Microwave Output	1000W (IEC 705 TEST PROCEDURE) Adjustable 100W through 1000W, 10 steps
Frequency	2,450 MHz \pm 50 MHz
Power Supply	120 VAC, 60 Hz
Rated Current	13 Amp. (Microwave oven only) 14 Amp. (Microwave oven+Cook top lamps+Ventilation fan)
Magnetron Cooling	Forced Air Cooling
Rectification	Rectification Voltage Double Half-Wave
Door Sealing	Choke System
Safety Devices	Magnetron Thermostat: Open at 150°C \pm 7°C (302°F \pm 44°F), short at 60°C \pm 15°C (140°F \pm 59°F) Oven Cavity Thermostat: Open at 110°C \pm 5°C (230°F \pm 41°F), short at 0°C (32°F) Fuse(20A) Primary Interlock Switch Secondary Interlock Switch Interlock Monitor
Magnetron	2M246-310GF or 2M248E
High Voltage Capacitor	Capacitor: 1.0 μ F, 2.1 KV AC
High Voltage Diode	Diode; 350mA, 9.0 KV
Cook top Lamp	125 V, 30 W
Cavity Lamp	125 V, 30 W or 40 W
Timer	Digital, up to 99 mim. 99 sec. (in each cooking stage)
Tray	Tempered Safety Glass
Overall Dimensions	29 ^{15/16} " (W)x16 ^{7/16} " (D)x15 ^{3/8} " (H)
Oven Cavity Size	19 ^{7/8} " (W)x14 ^{5/32} " (D)x8 ^{15/16} " (H)
Effective Capacity of Oven Cavity	1.5 Cu.ft.
Accessories	Owner's Manual & Cooking Guide, Installation Manual, Exhaust Adapter, Exhaust Damper, Mounting Kit and Two Filters, Rotating Ring Assembly.

CAUTIONS

Unlike other appliances, the microwave oven is high-voltage and high-current equipment. Though it is free from danger in ordinary use, extreme care should be taken during repair.

- DO NOT operate on a 2-wire extension cord during repair and use.
- NEVER TOUCH any oven components or wiring during operation.
- BEFORE TOUCHING any parts of the oven, always remove the power plug from the outlet.
- For about 30 seconds after the oven stops, an electric charge remains in the high voltage capacitor. When replacing or checking, you must discharge the high voltage capacitor by shorting across the two terminals with an insulated screwdriver.

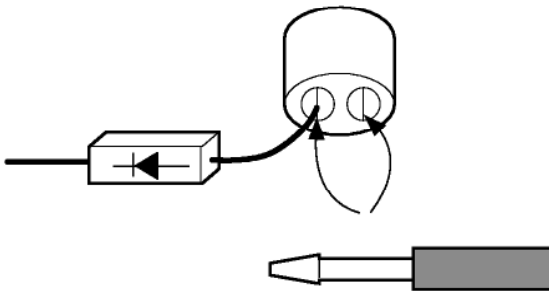

- Remove your watches whenever working close to or replacing the Magnetron.
- DO NOT touch any parts of the control panel circuit. A resulting static electric discharge may damage this P.C.B.
- NEVER operate the oven with no load.
- NEVER injure the door seal and front plate of the oven cavity.
- NEVER put iron tools on the magnetron.
- NEVER put anything into the latch hole and the interlock switches area.

MICROWAVE RADIATION

Personnel should not be exposed to the microwave energy which may radiate from the magnetron or other microwave generating device if it is improperly used or connection. All input and output microwave connections, waveguide, flange, and gasket must be secure never operate the device without a microwave energy absorbing load attached. Never look into an open waveguide or antenna while the device is energized.

- Proper operation of the microwave oven requires that the magnetron be assembled to the waveguide and cavity. Never operate the magnetron unless it is properly installed.
- **Be sure that the magnetron gasket is properly installed around the dome of the tube whenever installing the magnetron.**

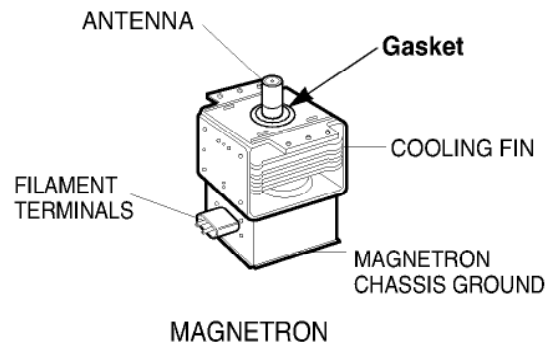

THE OVEN IS TO BE SERVICED ONLY BY PROPERLY QUALIFIED SERVICE PERSONNEL.

INSTALLATIONS

BEFORE YOU BEGIN, READ THE FOLLOWING INSTRUCTIONS COMPLETELY AND CAREFULLY.

PRECAUTIONS ON INSTALLATION

- A. Plug the power supply cord into a 120V AC, 60Hz, single-phase power source with a capacity of 15A or 20A.
- B. Avoid placing the unit in a location where there is direct heat or splashing water.
- C. Install the unit on the mounting plate firmly.
- D. Place the unit as far away as possible from TV, radio, etc. to prevent interference.

GROUNDING INSTRUCTIONS

For personal safety, this appliance must be fully grounded at all times.

In the event of an electrical short circuit, grounding reduces the risk of electrical shock.

The plug must be plugged into an outlet that is properly installed and grounded.

CAUTION

This unit is equipped with a 3-prong plug for your safety. If the wall outlet is a grounded 3-hole type, the unit will be grounded automatically.

**Plug with Ground
Prong**

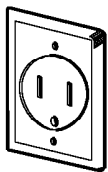
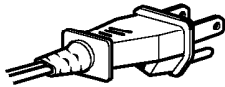

**Properly Polarized
and Grounded
Outlet**

WARNING

Improper use of the grounding plug can result in a risk of electric shock.

Do not, under any circumstances, cut or remove the third ground prong from the power cord plug.

OPERATING INSTRUCTIONS

CONTROL PANEL

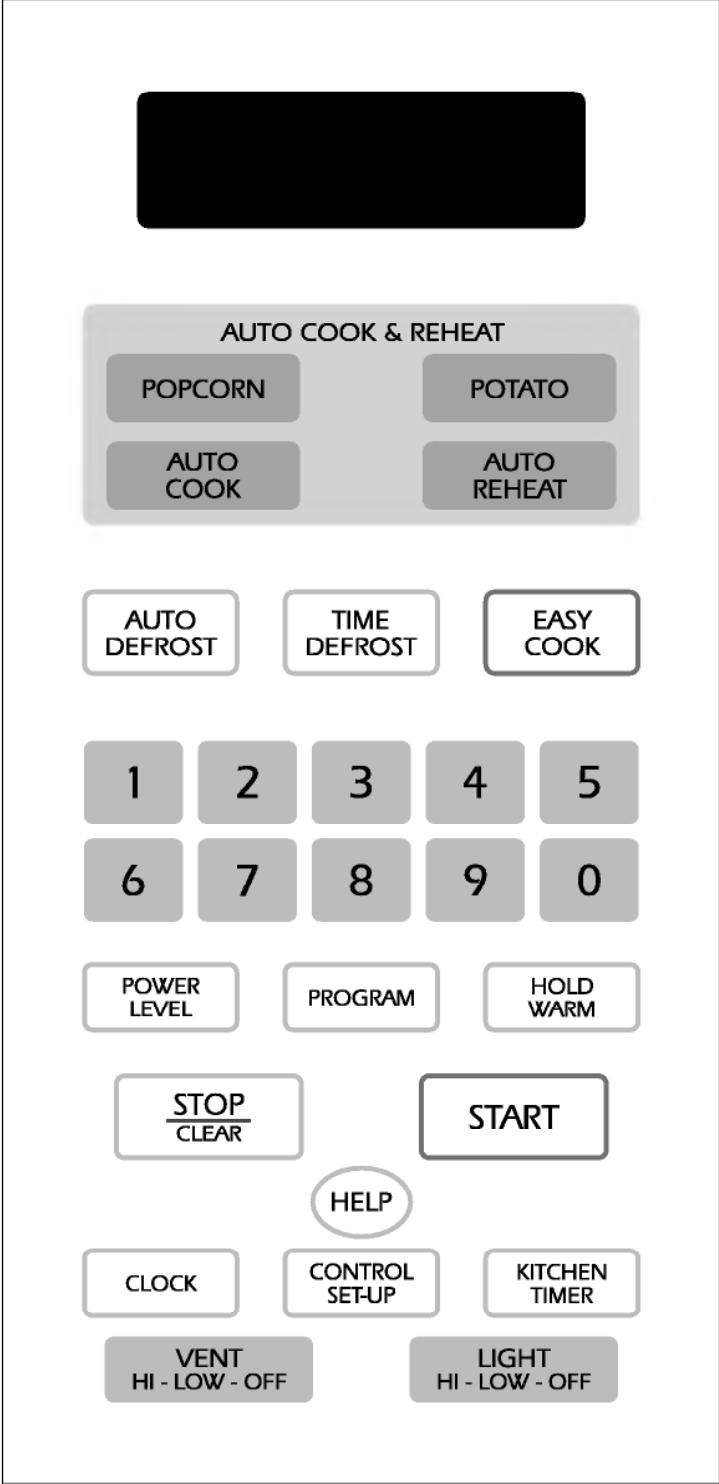

CONTROL PANEL INSTRUCTIONS

The entire operation is done by simple touch control pads.

- (1) **Display Window**
Numbers and letters are shown in the display window (Vacuum Fluorescent Tube).
Each Indicator Light shows which function is set and involved in the course of cooking by turning itself on. Indicator Lights automatically go out upon completion of cooking.
- (2) **POWER LEVEL Key**
Used to select cooking power level.
- (3) **EASY COOK Key**
Used to cook for one minute at 100% power level. It can be used to extend cooking time in multiples of one minute up to 99 minutes.
- (4) **CLOCK(TIME OF DAY) Key**
Used in setting Time of Day.
- (5) **STOP/CLEAR Key**
Used to stop the oven or clear all entries except Time of Day.
- (6) **START Key**
Touch the START key after setting the desired cooking times etc. Also touch the START key to resume cooking after the cooking is temporarily stopped by opening the door. The key will not function unless the door is closed.
- (7) **AUTO DEFROST Key**
Used to defrost for frozen foods by weight.
- (8) **TIME DEFROST Key**
Used to defrost for most other frozen foods by setting time.
- (9) **AUTO COOK & REHEAT Key**
Used to cook the preprogrammed food automatically.
- (10) **HELP Key**
This HELP key display feature information and helpful hints.
- (11) **KITCHEN TIMER Key**
Used to set the timer.
- (12) **CONTROL SET-UP Key**
Touch this pad to change the oven's default setting for sound, clock, display speed, defrost weight, and demo mode operations.
- (13) **VENT HI-LOW-OFF Key**
Touch FAN once for HIGH fan speed, twice for low fan speed, or threetimes to turn the fan off.
- (14) **LIGHT HI-LOW-OFF Key**
Touch LIGHT once for bright light, twice for the night light, or three times to turn the light off.
- (15) **HOLD WARM Key**
Used to keep hot, cooked foods warm.
- (16) **PROGRAM Key**
Used to set a cooking time.

OVERALL CIRCUIT DIAGRAM

SCHEMATIC DIAGRAM

***Note**

1. DOOR OPENED & COOK OFF MODE.
2. BLUE MARK ON LAMP SOCKET MUST BE CONNECTED TO LIVE PART (BLACK WIRE).
3. ONLY CERTAIN MODELS USE THE ABSOLUTE HUMIDITY SENSOR.

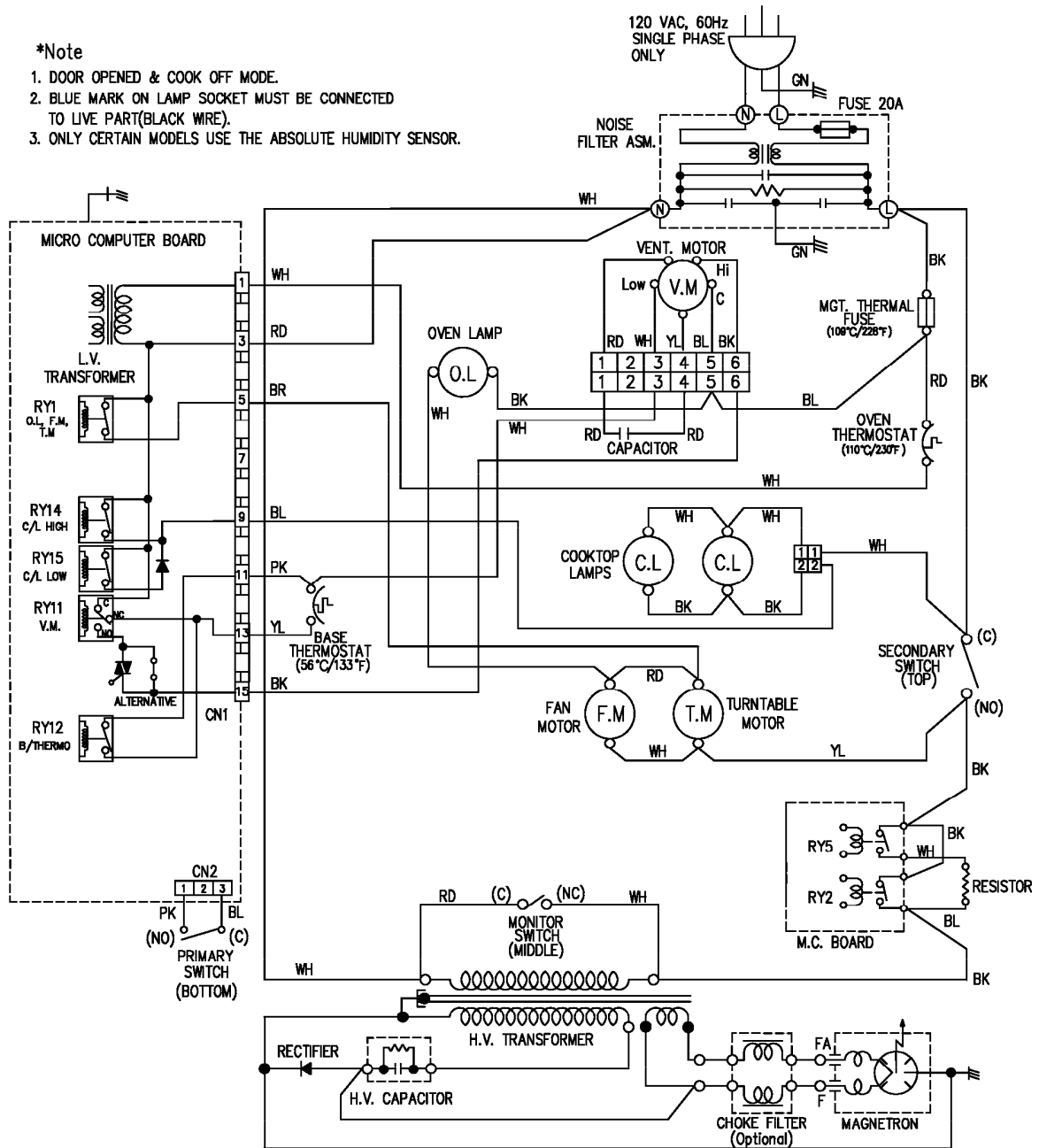

CONTROL MODULE

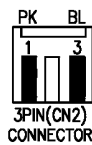
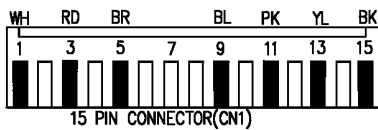

WIRE COLORS

SYMBOL	COLOR
WH	WHITE
BK	BLACK
RD	RED
YL	YELLOW
PK	PINK
BL	BLUE
BR	BROWN
GN	GREEN
GY	GREY

MATRIX CIRCUIT FOR TOUCH KEY BOARD

	1	2	3	4	5	6	7
8	VENT□ HI/LO/OFF	HELP	AUTO□ COOK	POPCORN	PROGRAM	5	0
9	LIGHT□ HI/LO/OFF	CONTROL□ SET-UP	AUTO□ REHEAT	POTATO	AUTO□ DEFROST	6	1
10	N.C	CLOCK□ AM/PM	EASY□ COOK	N.C	KITCHEN□ TIMER	7	2
11	N.C	N.C	TIME□ DEFROST	N.C	POWER□ LEVEL	8	3
12	N.C	STOP/□ CLEAR	START	N.C	HOLD□ WARM	9	4
13	N.C	N.C	N.C	N.C	N.C	N.C	N.C

GENERAL INFORMATION FOR SERVICE

GENERAL PRECAUTIONS IN USE

A. **Never operate the unit when it is empty.**

Operating the oven with no load may shorten the life of the magnetron. Whenever cooking dry foods (dried fish, bread, etc.) or a small amount of food, be sure to put a glass of water into the cooking compartment. The glass turntable may become hot after operating, be careful when touching it.

B. Aluminum foil should be avoided because it will disrupt cooking and may cause arcing. However, small pieces may be used to cover some parts of food to slow the cooking. Any aluminum foil used should never be closer than 2.5 cm to any side wall of the oven.

- (1) Primary interlock switch
- (2) Secondary interlock switch
- (3) Interlock monitor switch
- (4) Choke system
- (5) Magnetron thermostat
- (6) Oven cavity thermostat

(Note: This thermostat located on the oven cavity will open and stop the unit from operation only if a high temperature is reached, such as, a fire created by overcooking food.)

B. Any one of 10 power output levels ranging 100W to 1000W can be selected by the touch control and electronic computer system.

TRIAL OPERATION

After installation, the following sequences and results should be checked carefully.

- A. Put a container filled with water (about 1 liter) into the oven, and close the door tightly.
- B. Set cooking time for 10 minutes by touching "1" and then "0" three times. "1, 0, 0, 0" appears in the display window.
- C. Touch the START key.
Make sure the cavity light comes on. The unit will begin cooking and the display window will show the time counting down by seconds.
- D. After about 5 minutes, make sure the primary interlock switch, the secondary interlock switch and the interlock monitor switch operate properly by opening and closing the door several times. Touch the START key each time the door is closed.
- E. Continue operating the unit. Two short and a long beep sound signal is heard when the time is up.
The unit will shut off automatically.
- F. Confirm the water is hot.
- G. Finally, measure the output power according to "POWER OUTPUT MEASUREMENT" on page 7-3.

FEATURES AND SPECIFICATIONS

FEATURES

- A. The safety systems incorporated in this model are: